

Small Signal Schottky Diode

Features

- Epoxy meets UL-94 V-0 flammability rating and halogen free
- Moisture Sensitivity Level 1
- Low Turn-on Voltage
- V_{RRM} 100V
- I_{FAV} 150mA
- Part no. with suffix "Q" means AEC-Q101 qualified

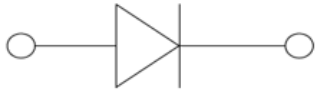

SOD123

Mechanical Data

- **Case:** SOD123
- **Terminals:** Tin plated leads, solderable per J-STD-002 and JESD22-B102
- **Polarity:** Cathode line denotes the cathode end

■ Maximum Ratings ($T_a=25^\circ\text{C}$ Unless otherwise specified)

| PARAMETER | SYMBOL | UNIT | CONDITIONS | VALUE |
|---|------------|------------------|------------------|-------------|
| Maximum Repetitive peak reverse voltage | V_{RRM} | V | | 100 |
| Average Forward Current | I_{FAV} | mA | | 150 |
| Peak Forward Surge Current | I_{FSM} | A | 8.3ms, half sine | 5 |
| Power Dissipation | P_{tot} | mW | | 200 |
| Thermal Resistance Junction to Ambient | R_{thJA} | K/W | | 500 |
| Junction Temperature | T_J | $^\circ\text{C}$ | | -55 to +125 |
| Storage Temperature Range | T_{stg} | $^\circ\text{C}$ | | -55 to +150 |



BAT46WQ

■ Electrical Characteristics (T_a=25°C Unless otherwise specified)

| PARAMETER | SYMBOL | UNIT | CONDITIONS | MIN | MAX |
|---------------------------|-----------------|------|--|-----|------|
| Forward Voltage | V _F | V | I _F =0.1mA | | 0.25 |
| | | | I _F =10mA | | 0.45 |
| | | | I _F =250mA | | 1 |
| Reverse Leakage Current | I _R | uA | V _R =1.5V | | 0.3 |
| | | | V _R =10V | | 0.5 |
| | | | V _R =50V | | 1 |
| | | | V _R =75V | | 2 |
| Reverse Breakdown Voltage | V _{BR} | V | I _R =100uA | 100 | |
| Junction Capacitance | C _J | pF | V _R =0V, f =1MHz | | 20 |
| | | | V _R =1V, f =1MHz | | 12 |
| Reverse Recovery Time | t _{rr} | ns | I _F =I _R =10mA, I _{rr} =1mA, R _L =100Ω | | 3 |

■ Ordering Information (Example)

| PREFERRED P/N | PACKING CODE | UNIT WEIGHT(g) | MINIMUM PACKAGE(pcs) | INNER BOX QUANTITY(pcs) | OUTER CARTON QUANTITY(pcs) | DELIVERY MODE |
|---------------|--------------|-------------------|----------------------|-------------------------|----------------------------|---------------|
| BAT46WQ | F2 | Approximate 0.010 | 3000 | 30000 | 120000 | 7" reel |



BAT46WQ

■ Characteristics (Typical)

Fig.1: P_D-T_A

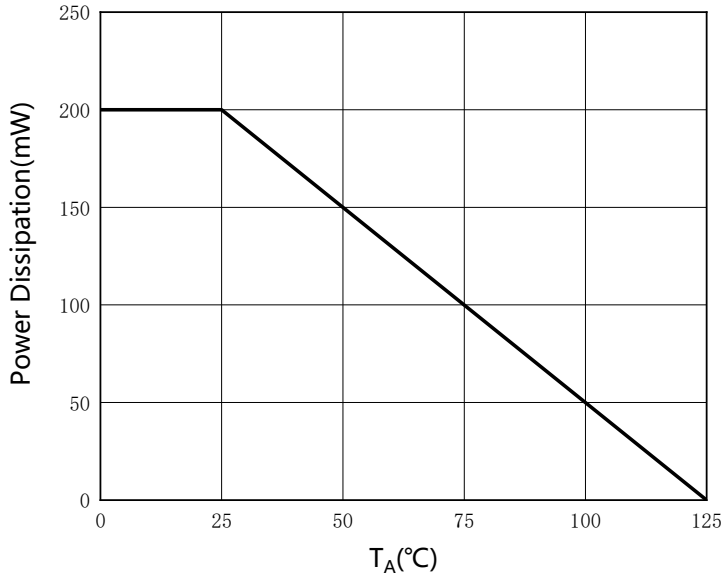

Fig.2: Capacitance Characteristics

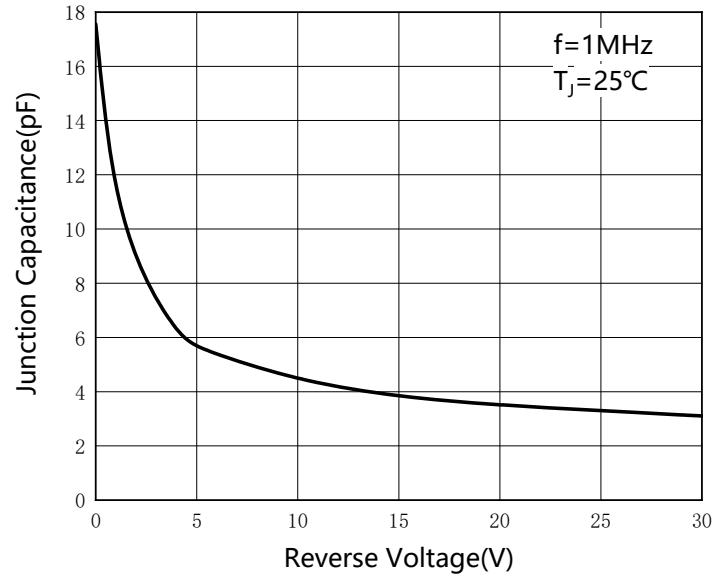

Fig.3: Forward Characteristics

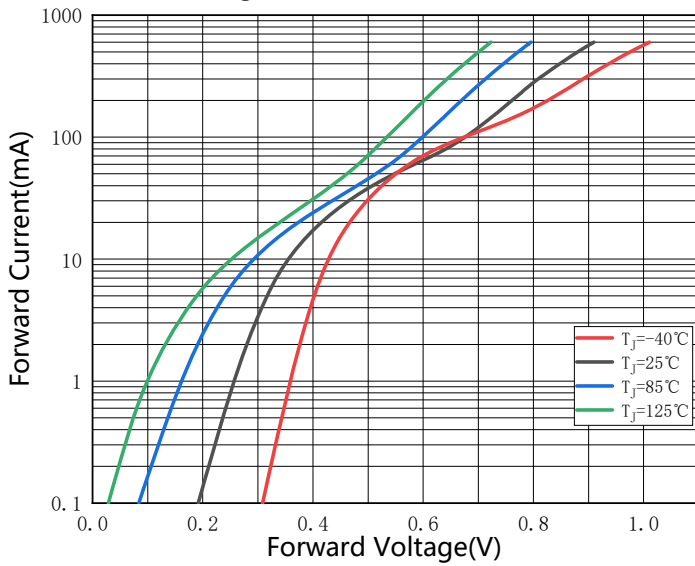
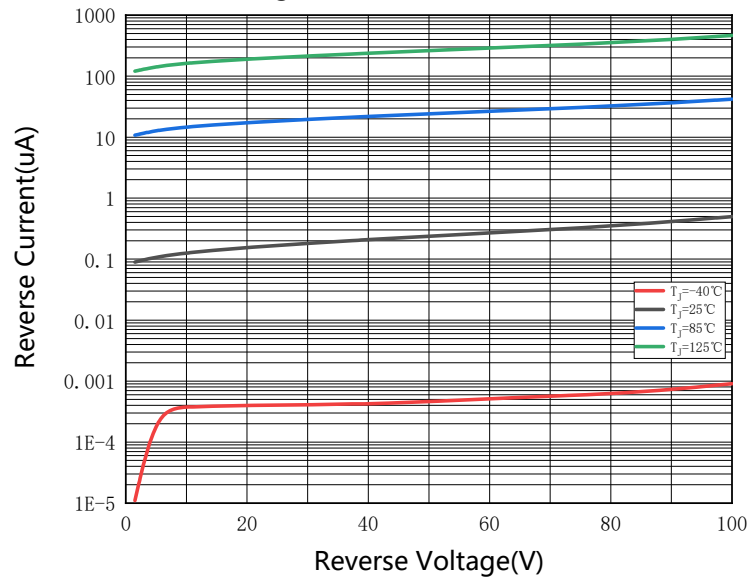

Fig.4: Reverse Characteristics





BAT46WQ

■ Outline Dimensions

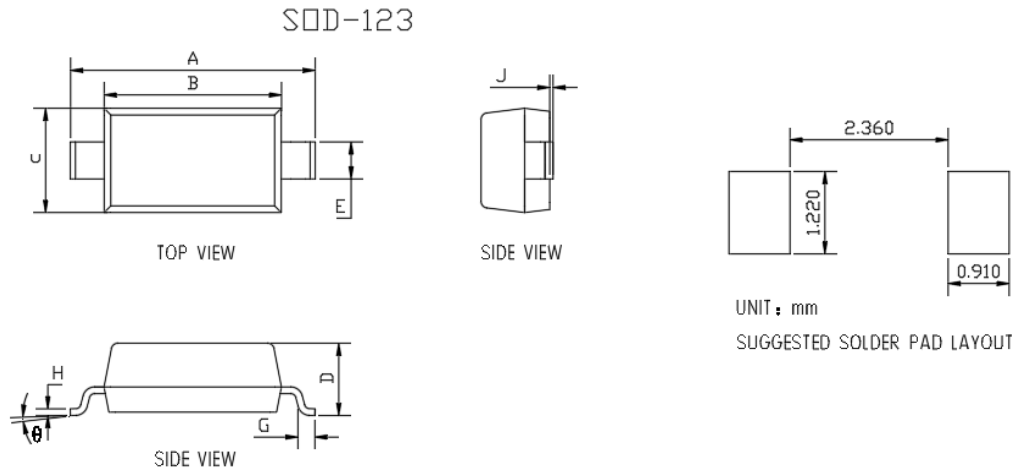

| DIMENSIONS | | | | |
|------------|--------|-------|-------|-------|
| DIM | INCHES | | MM | |
| | MIN | MAX | MIN | MAX |
| A | 0.140 | 0.152 | 3.550 | 3.850 |
| B | 0.100 | 0.112 | 2.550 | 2.850 |
| C | 0.055 | 0.071 | 1.400 | 1.800 |
| D | 0.037 | 0.053 | 0.950 | 1.350 |
| E | 0.020 | 0.028 | 0.510 | 0.710 |
| G | 0.006 | 0.018 | 0.150 | 0.450 |
| H | 0.003 | 0.010 | 0.080 | 0.250 |
| J | 0.000 | 0.006 | 0.000 | 0.150 |
| θ | 0 | 8° | 0 | 8° |

■ Marking Information

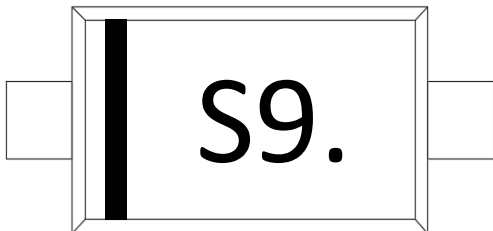

Note:

1. All marking is at middle of the product body
2. All marking is in laser marking
3. Body color: Black



BAT46WQ

Disclaimer

The information presented in this document is for reference only. Yangzhou Yangjie Electronic Technology Co., Ltd. reserves the right to make changes without notice for the specification of the products displayed herein to improve reliability, function or design or otherwise.

The product listed herein is designed to be used with automotive electronics, are not designed for use in medical, life-saving, life-sustaining, or military, Yangjie or anyone on its behalf, assumes no responsibility or liability for any damages resulting from such improper use of sale.

This publication supersedes & replaces all information previously supplied. For additional information, please visit our website [http:// www.21yangjie.com](http://www.21yangjie.com) , or consult your nearest Yangjie's sales office for further assistance.

X-ON Electronics

Largest Supplier of Electrical and Electronic Components

Click to view similar products for [Schottky Diodes & Rectifiers](#) category:

Click to view products by [Yangjie](#) manufacturer:

Other Similar products are found below :

[MA4E2039](#) [MMBD301M3T5G](#) [HFA35HB60C](#) [RB160M-50TR](#) [D83C](#) [BAS16E6433HTMA1](#) [BAS 3010S-02LRH](#) [E6327](#) [BAT 54-02LRH](#)
[E6327](#) [NRVBAF360T3G](#) [NSR05F40QNXT5G](#) [NTE555](#) [SS3003CH-TL-E](#) [GA01SHT18](#) [CRS10I30A\(TE85L,QM](#) [MBRA140TRPBF](#)
[MBRB30H30CT-1G](#) [BAT 15-04R](#) [E6152](#) [JANTX1N5712-1](#) [DMJ3940-000](#) [SB007-03C-TB-E](#) [NRVBB20100CTT4G](#) [NRVBM120LT1G](#)
[NTSB30U100CT-1G](#) [CRG04\(T5L,TEMQ\)](#) [ACDBA1100LR-HF](#) [ACDBA1200-HF](#) [ACDBA240-HF](#) [ACDBA3100-HF](#) [CDBQC0530L-HF](#)
[ACDBA260LR-HF](#) [ACDBA1100-HF](#) [10BQ015-M3/5BT](#) [NRVBM120ET1G](#) [VSSB410S-M3/5BT](#) [1N5819T-G](#) [PDS1040Q-13](#) [B160BQ-13-F](#)
[SDM05U20CSP-7](#) [BAS 70-07](#) [E6433](#) [B140S1F-7](#) [HSM560Je3/TR13](#) [DDB2265-000](#) [ZHCS506QTA](#) [HSM190Je3/TR13](#) [B330AF-13](#)
[ACDBUC0230-HF](#) [SDM1U100S1F-7](#) [MBR10200CTF-G1](#) [CDLL5712](#) [DMF2822-000](#)