



## Small Signal Schottky Rectifier



### Features

- Epoxy meets UL-94 V-0 flammability rating and halogen free
- Moisture Sensitivity Level 1
- Low Forward Voltage Schottky Rectifier
- VR 30V
- IFAV 0.2A
- Part no. with suffix "Q" means AEC-Q101 qualified

### Mechanical Data

- **Case:** SOT-323
- **Terminals:** Tin plated leads, solderable per J-STD-002 and JESD22-B102

### SOT-323

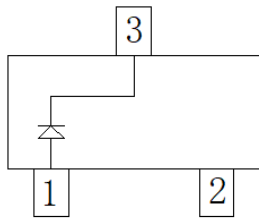

BAT54WTQ  
Marking:KL5

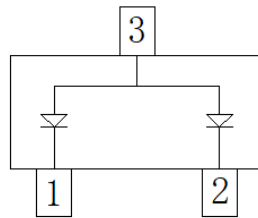

BAT54AWTQ  
Marking:KL6

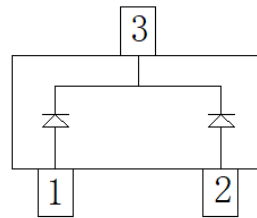

BAT54CWTQ  
Marking:KL7

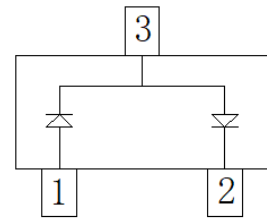

BAT54SWTQ  
Marking:KL8

### ■ Maximum Ratings (T<sub>a</sub>=25°C Unless otherwise specified)

PARAMETER	SYMBOL	UNIT	CONDITIONS	VALUE
Reverse Voltage	V <sub>R</sub>	V		30
Average Forward Current	I <sub>FAV</sub>	mA		200
Non-repetitive Peak Forward Surge Current	I <sub>FSM</sub>	A	square wave tp<10ms	0.6
Power Dissipation	P <sub>D</sub>	mW		200
Thermal Resistance Junction to Ambient	R <sub>thJA</sub>	°C/W		500
Maximum Junction Temperature	T <sub>j</sub>	°C		125
Storage Temperature Range	T <sub>stg</sub>	°C		-55 to +150



## ■ Electrical Characteristics (T<sub>a</sub>=25°C Unless otherwise specified)

PARAMETER	SYMBOL	UNIT	CONDITIONS	MIN	MAX
Forward Voltage	V <sub>F</sub>	V	I <sub>F</sub> =0.1mA	-	0.24
			I <sub>F</sub> =1.0mA	-	0.32
			I <sub>F</sub> =10mA	-	0.40
			I <sub>F</sub> =30mA	-	0.50
			I <sub>F</sub> =100mA	-	1.0
Reverse Current	I <sub>R</sub>	μA	V <sub>R</sub> =25V	-	2
Junction Capacitance	C <sub>J</sub>	pF	V <sub>R</sub> =1 V, f =1MHz	-	10
Reverse Recovery Time	t <sub>rr</sub>	ns	I <sub>F</sub> =I <sub>R</sub> =10mA, I <sub>rr</sub> =1mA, R <sub>L</sub> =100Ω	-	5

## ■ Ordering Information (Example)

PREFERRED P/N	PACKING CODE	UNIT WEIGHT(g)	MINIMUM PACKAGE(pcs)	INNER BOX QUANTITY(pcs)	OUTER CARTON QUANTITY(pcs)	DELIVERY MODE
BAT54WTQ BAT54AWTQ BAT54CWTQ BAT54SWTQ	F2	Approximate 0.006	3000	30000	120000	7" reel

## ■ Characteristics (Typical)

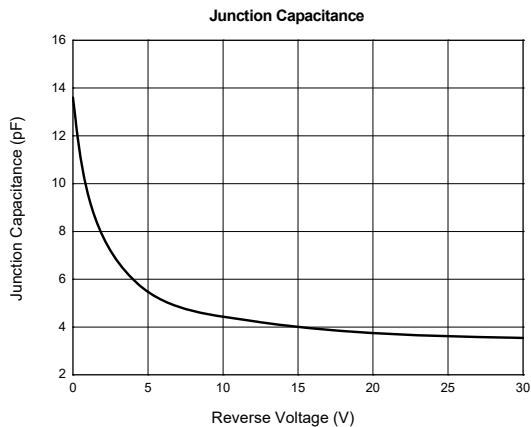
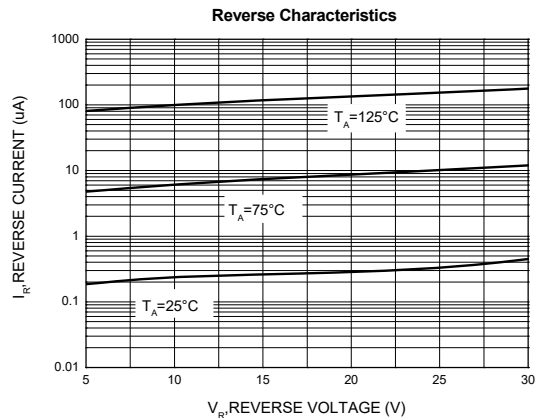
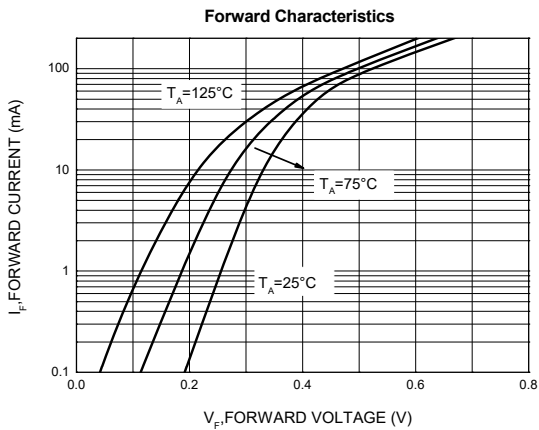



## ■ Outline Dimensions

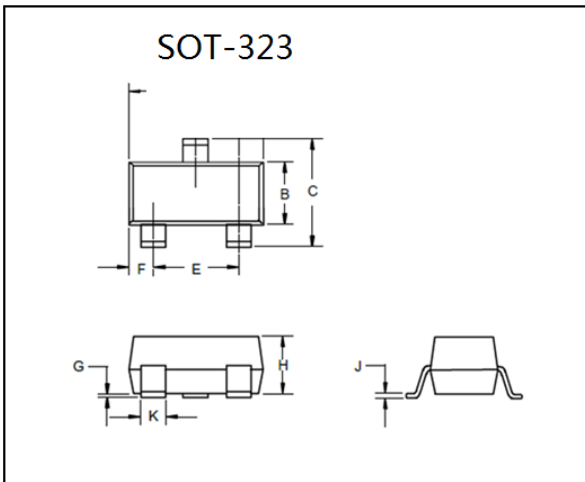

DIM	INCHES		MM		NOTE
	MIN	MAX	MIN	MAX	
A	0.071	0.087	1.80	2.20	
B	0.045	0.053	1.15	1.35	
C	0.083	0.096	2.10	2.45	
D	0.026Nominal		0.65Nominal		
E	0.047	0.055	1.20	1.40	
F	0.012	0.016	0.30	0.40	
G	0.000	0.004	0.00	0.10	
H	0.035	0.039	0.90	1.00	
J	0.004	0.010	0.10	0.250	
K	0.006	0.016	0.15	0.40	

## ■ Soldering Footprint

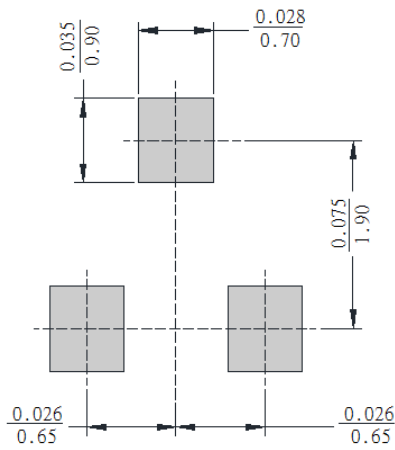

Unit:  $\frac{\text{inch}}{\text{mm}}$



## Disclaimer

The information presented in this document is for reference only. Yangzhou Yangjie Electronic Technology Co., Ltd. reserves the right to make changes without notice for the specification of the products displayed herein to improve reliability, function or design or otherwise.

The product listed herein is designed to be used with automotive electronics, are not designed for use in medical, life-saving, lifesustaining, or military, Yangjie or anyone on its behalf, assumes no responsibility or liability for any damages resulting from such improper use of sale.

This publication supersedes & replaces all information previously supplied. For additional information, please visit our website [http:// www.21yangjie.com](http://www.21yangjie.com) , or consult your nearest Yangjie's sales office for further assistance.

## X-ON Electronics

Largest Supplier of Electrical and Electronic Components

*Click to view similar products for [Schottky Diodes & Rectifiers](#) category:*

*Click to view products by [Yangjie](#) manufacturer:*

Other Similar products are found below :

[CUS06\(TE85L,Q,M\)](#) [MA4E2039](#) [D1FH3-5063](#) [MBR0530L-TP](#) [MBR10100CT-BP](#) [MBR30H100MFST1G](#) [MMBD301M3T5G](#) [PMAD1103-LF](#) [PMAD1108-LF](#) [RB160M-50TR](#) [RB520S-30](#) [RB551V-30](#) [DD350N18K](#) [DZ435N40K](#) [DZ600N16K](#) [BAS16E6433HTMA1](#) [BAS 3010S-02LRH E6327](#) [BAT 54-02LRH E6327](#) [IDL02G65C5XUMA1](#) [NSR05F40QNXT5G](#) [NSVR05F40NXT5G](#) [JANS1N6640](#) [SB07-03C-TB-H](#) [SB1003M3-TL-W](#) [SBAT54CWT1G](#) [SBM30-03-TR-E](#) [SBS818-TL-E](#) [SK32A-LTP](#) [SK33A-TP](#) [SK34A-TP](#) [SK34B-TP](#) [SMD1200PL-TP](#) [ACDBN160-HF](#) [SS3003CH-TL-E](#) [STPS30S45CW](#) [PDS3100Q-7](#) [GA01SHT18](#) [CRS10I30A\(TE85L,QM\)](#) [MBR1240MFST1G](#) [MBRB30H30CT-1G](#) [BAS28E6433HTMA1](#) [BAS 70-02L E6327](#) [HSB123JTR-E](#) [JANTX1N5712-1](#) [VS-STPS40L45CW-N3](#) [DD350N12K](#) [SB007-03C-TB-E](#) [SB10015M-TL-E](#) [SB1003M3-TL-E](#) [SK110-LTP](#)