

Small Signal Switching Diodes

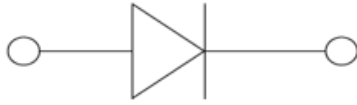

SOD323

Features

- Epoxy meets UL-94 V-0 flammability rating and halogen free
- Moisture Sensitivity Level 1
- V_{RRM} 120V to 250V
- I_{FAV} 200mA
- Part no. with suffix "Q" means AEC-Q101 qualified

Applications

- General Purpose Switches Diodes

Mechanical Data

- **Case:** SOD323
- **Terminals:** Tin plated leads, solderable per J-STD-002 and JESD22-B102
- **Polarity:** Cathode line denotes the cathode end
- **Marking:**

	Marking
BAV19WSQ	A8
BAV20WSQ	T2
BAV21WSQ	T3

■ Maximum Ratings ($T_a=25^\circ\text{C}$ Unless otherwise specified)

PARAMETER	SYMBOL	UNIT	CONDITIONS	PART	VALUE
Reverse Voltage	V_R	V		BAV19WSQ	100
				BAV20WSQ	150
				BAV21WSQ	200
Repetitive Peak Reverse Voltage	V_{RRM}	V		BAV19WSQ	120
				BAV20WSQ	200
				BAV21WSQ	250
Average Forward Current	I_{FAV}	mA			200
Non-Repetitive Peak Forward Surge Current	I_{FSM}	A	$t_p < 10\text{ms}$		1.7
Power Dissipation	P_{tot}	mW			250
Thermal Resistance Junction to Ambient	R_{thJA}	K/W			500
Maximum Junction Temperature	T_j	$^\circ\text{C}$			150
Storage Temperature Range	T_{stg}	$^\circ\text{C}$			-55 to +150



BAV19WSQ THRU BAV21WSQ

■ Electrical Characteristics (T_a=25°C Unless otherwise specified)

PARAMETER	SYMBOL	UNIT	CONDITIONS		MIN	MAX
Reverse Voltage	V _R	V	BAV19WSQ	I _R =100uA	100	
			BAV20WSQ	I _R =100uA	150	
			BAV21WSQ	I _R =100uA	200	
Forward Voltage	V _F	V	I _F =100mA			1.0
			I _F =200mA			1.25
Reverse Current	I _R	μA	BAV19WSQ	V _R =100V		0.1
			BAV20WSQ	V _R =150V		0.1
			BAV21WSQ	V _R =200V		0.1
Diode Capacitance	C _D	pF	V _R =V _F =0V, f = 1MHz			5
Reverse Recovery Time	t _{rr}	ns	I _F =30mA, I _{rr} =0.1I _R , R _L =100Ω			50

■ Ordering Information (Example)

PREFERRED P/N	PACKING CODE	UNIT WEIGHT(g)	MINIMUM PACKAGE(pcs)	INNER BOX QUANTITY(pcs)	OUTER CARTON QUANTITY(pcs)	DELIVERY MODE
BAV19WSQ THRU BAV21WSQ	F2	Approximate 0.0045	3000	30000	120000	7" reel

■ Characteristics (Typical)

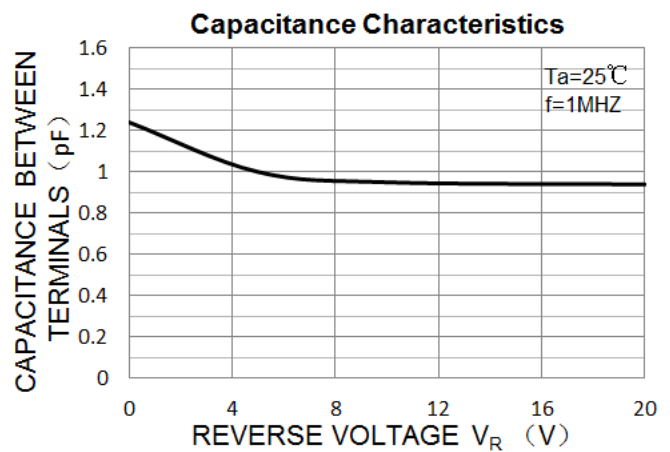
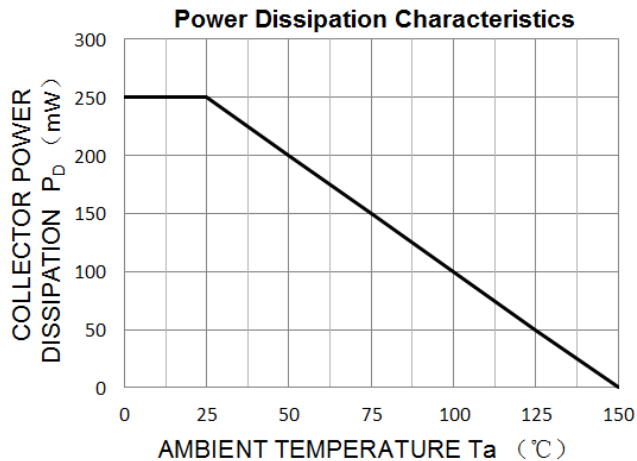



BAV19WSQ THRU BAV21WSQ

■ Characteristics (Typical)

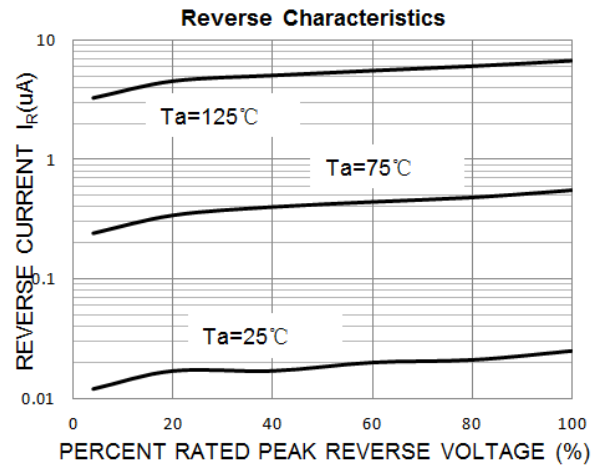
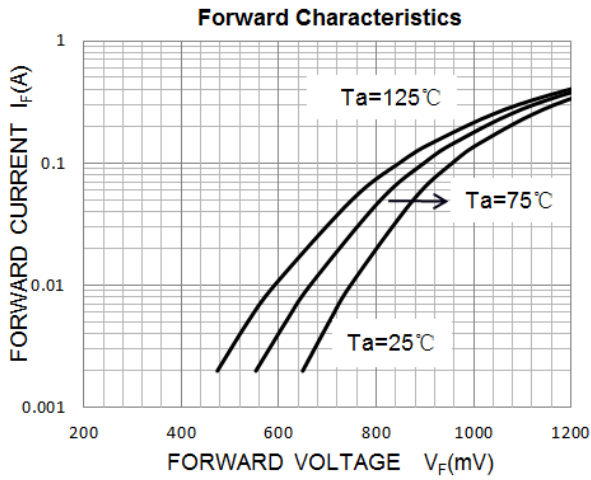

■ Outline Dimensions

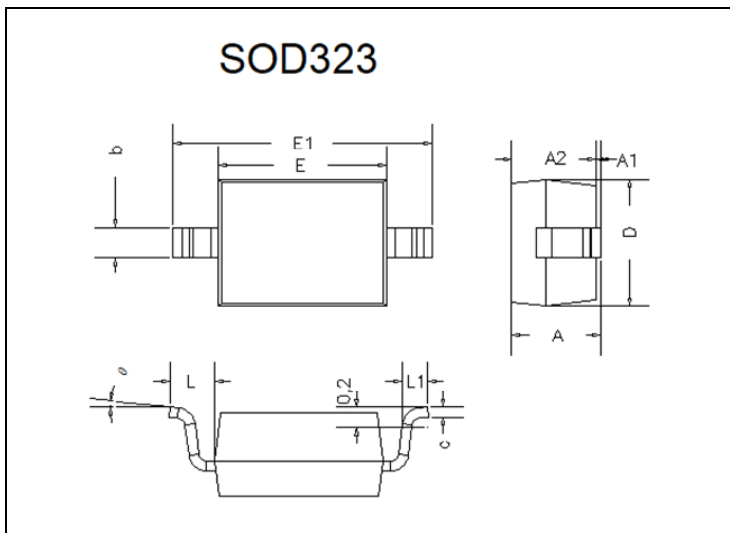

DIM	INCHES		MM		NOTE
	MIN	MAX	MIN	MAX	
A	-	0.039	-	1.00	
A1	0.000	0.004	0.00	0.10	
A2	0.031	0.035	0.80	0.90	
b	0.010	0.016	0.25	0.40	
c	0.003	0.007	0.08	0.17	
D	0.047	0.055	1.20	1.40	
E	0.063	0.071	1.60	1.80	
E1	0.098	0.106	2.50	2.70	
L	0.019REF		0.475REF		
L1	0.008	0.016	0.20	0.40	
θ	0°	8°	0°	8°	

■ Soldering Footprint

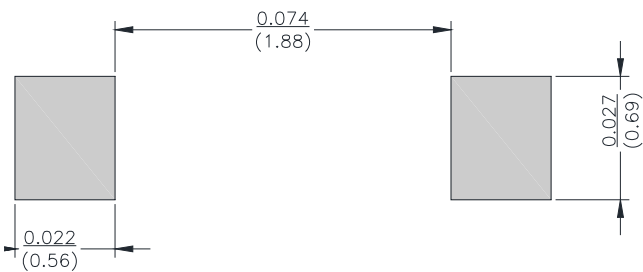

Unit: $\frac{\text{inch}}{\text{mm}}$



BAV19WSQ THRU BAV21WSQ

Disclaimer

The information presented in this document is for reference only. Yangzhou Yangjie Electronic Technology Co., Ltd. reserves the right to make changes without notice for the specification of the products displayed herein to improve reliability, function or design or otherwise.

The product listed herein is designed to be used with automotive electronics, are not designed for use in medical, life-saving, life-sustaining, or military, Yangjie or anyone on its behalf, assumes no responsibility or liability for any damages resulting from such improper use of sale.

This publication supersedes & replaces all information previously supplied. For additional information, please visit our website [http:// www.21yangjie.com](http://www.21yangjie.com) , or consult your nearest Yangjie's sales office for further assistance.

X-ON Electronics

Largest Supplier of Electrical and Electronic Components

Click to view similar products for [Diodes - General Purpose, Power, Switching category](#):

Click to view products by [Yangjie manufacturer](#):

Other Similar products are found below :

[MMBD3004S-13-F](#) [1N3611](#) [NTE156A](#) [NTE6244](#) [1SS400CST2RA](#) [SDAA13](#) [SHN2D02FUTW1T1G](#) [1N4449](#) [1N456A](#) [1N914BTR](#)
[D291S45T](#) [BAS 16-02L E6327](#) [BAS 16-02V H6327](#) [BAS 21U E6327](#) [BAS 28 E6327](#) [BAW56DWQ-7-F](#) [BAW56M3T5G](#) [BAW75-TAP](#)
[MM230L-CAA](#) [IDW40E65D1](#) [JAN1N3600](#) [JAN1N4454UR-1](#) [SMMSD4148T3G](#) [BYW95B/A52A](#) [NSVDAN222T1G](#) [CDSZC01100-HF](#)
[BAV70HDW-7](#) [BAS28-7](#) [JANTX1N6640](#) [BAW56HDW-13](#) [BAS28 TR](#) [VS-HFA04SD60STR-M3](#) [1SS388-TP](#) [BAV99TQ-13-F](#)
[BAV99HDW-13](#) [1N4004](#) [MMDB30-E28X](#) [LS4148](#) [IDV15E65D2](#) [W0503RH200S0L](#) [M0268SJ200NLF](#) [M0268RJ200NLF](#) [S3MBF](#) [US1J](#)
[DAN217U-TP](#) [SHV-06JNS-Q](#) [IDW30C65D1](#) [IDW80C65D1](#) [VS-HFA30TA60CSR-M3](#) [M1MA152WAT1](#)