

Dual Switching Diode

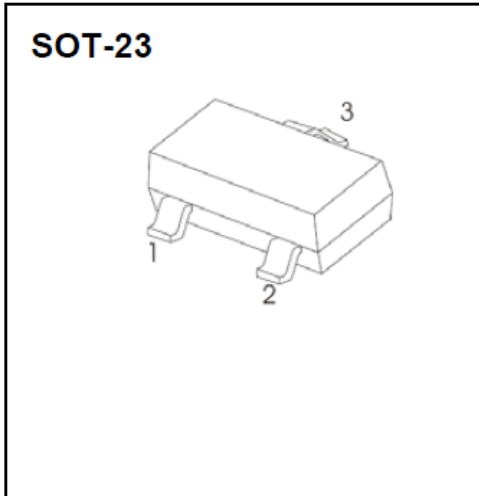

Features

- Epoxy meets UL-94 V-0 flammability rating
- Moisure Sensitivity Level 1
- Fast Switching Speed
- High Conductance
- For General Purpose Switching Applications

| BAV23A | BAV23C | BAV23S |
|---------------------|---------------------|----------------------|
| | | |
| MARKING: KT7 | MARKING: KT6 | MARKING: KL31 |

■ Maximum Rating, ($T_a=25^{\circ}\text{C}$ Unless otherwise specified)

| Item | Symbol | Unit | Value |
|---|------------|-----------------------------|-------------|
| Repetitive peak reverse voltage | V_{RRM} | V | 250 |
| Average Rectified Output Current | I_o | mA | 200 |
| Power Dissipation | P_D | mW | 350 |
| Thermal Resistance from Junction to Ambient | R_{thJA} | $^{\circ}\text{C}/\text{W}$ | 357 |
| Operation Junction Temperature | T_J | $^{\circ}\text{C}$ | -55 to +150 |
| Storage Temperature | T_{STG} | $^{\circ}\text{C}$ | -55 to +150 |

■ Ordering Information (Example)

| PREFERED P/N | PACKING CODE | UNIT WEIGHT(g) | MINIMUM PACKAGE(pcs) | INNER BOX QUANTITY(pcs) | OUTER CARTON QUANTITY(pcs) | DELIVERY MODE |
|--------------|--------------|-------------------|----------------------|-------------------------|----------------------------|---------------|
| BAV23C | F2 | Approximate 0.008 | 3000 | 30000 | 120000 | 7" reel |



BAV23A/C/S

■ Electrical Characteristics (T_a=25°C Unless otherwise specified, Per Leg)

| Item | Symbol | Unit | Conditions | Min | Typ | Max |
|-----------------------|------------------|------|--|-----|-----|------|
| Reverse Voltage | V _{BR} | V | I _R =100uA | 250 | | |
| Forward Voltage | V _F | V | I _{FM} =100mA, T _J =25°C | | | 1 |
| | | | I _{FM} =200mA, T _J =25°C | | | 1.25 |
| Reverse Current | I _R | uA | V _R =200V | | | 0.1 |
| Total Capacitance | C _{tot} | pF | f=1.0MHz, V _R =0V | | | 5 |
| Reverse Recovery Time | T _{rr} | ns | I _F =I _R =30mA, V _R =6V, R _L =100Ω, I _{rr} =3mA | | | 50 |

■ Typical Characteristics (Per Leg)

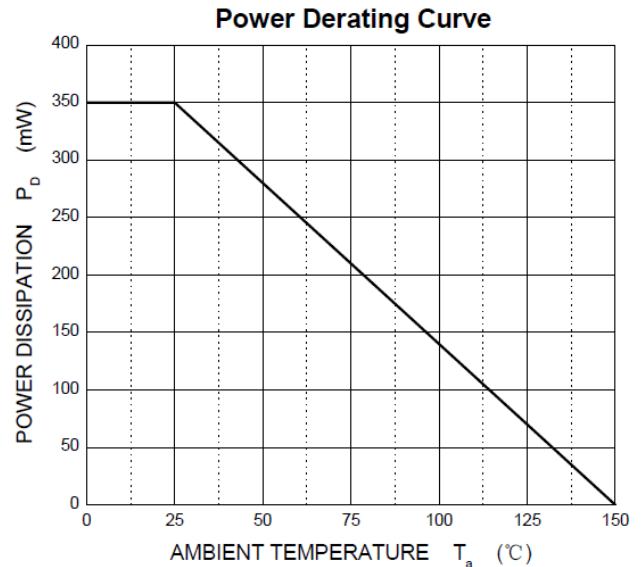
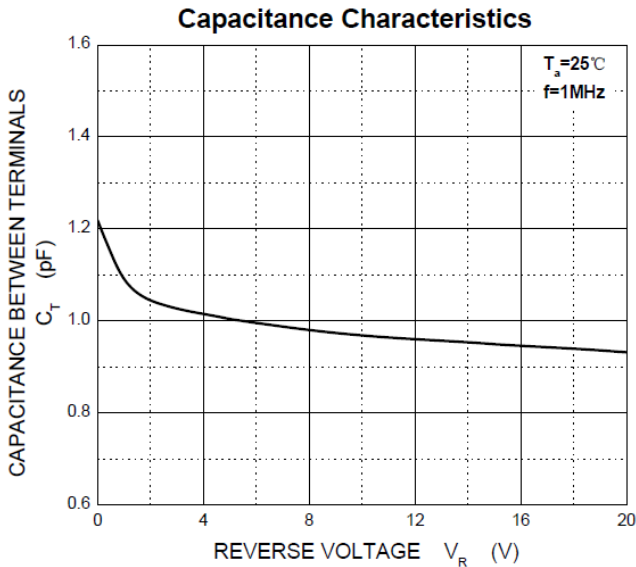
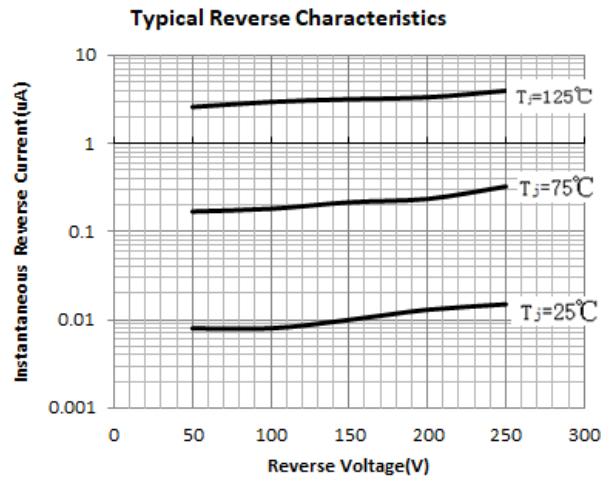
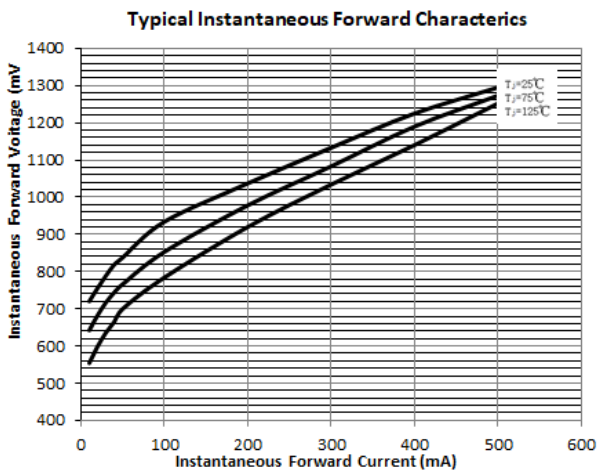



BAV23A/C/S

■SOT-23 Package Outline Dimensions

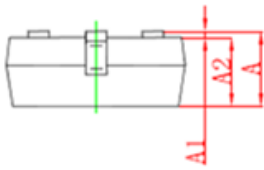
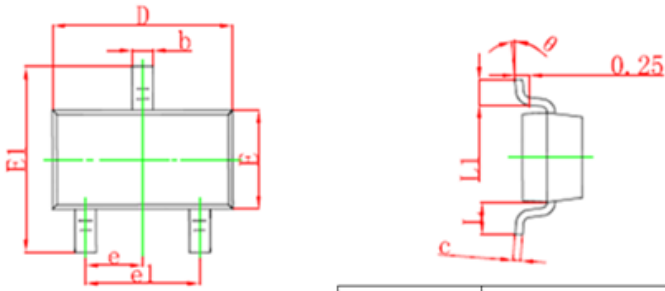

| Symbol | Dimensions In Millimeters | | Dimensions In Inches | |
|--------|---------------------------|-------|----------------------|-------|
| | Min | Max | Min | Max |
| A | 0.900 | 1.150 | 0.035 | 0.045 |
| A1 | 0.000 | 0.100 | 0.000 | 0.004 |
| A2 | 0.900 | 1.050 | 0.035 | 0.041 |
| b | 0.300 | 0.500 | 0.012 | 0.020 |
| c | 0.100 | 0.200 | 0.004 | 0.008 |
| D | 2.800 | 3.000 | 0.110 | 0.118 |
| E | 1.200 | 1.400 | 0.047 | 0.055 |
| E1 | 2.250 | 2.550 | 0.089 | 0.100 |
| e | 0.950TYP | | 0.037TYP | |
| e1 | 1.800 | 2.000 | 0.071 | 0.079 |
| L | 0.550REF | | 0.022REF | |
| L1 | 0.300 | 0.500 | 0.012 | 0.020 |
| θ | 0° | 8° | 0° | 8° |

■SOT-23Suggested Pad Layout

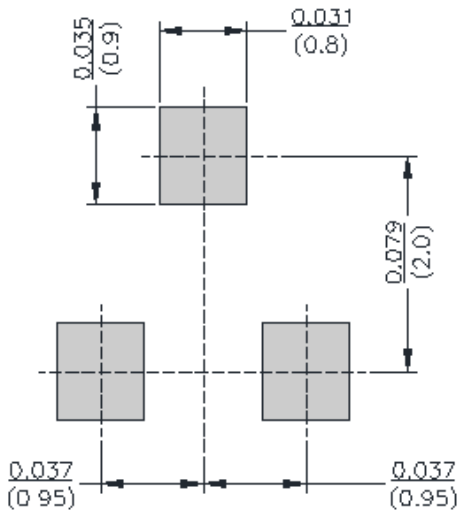



Disclaimer

The information presented in this document is for reference only. Yangzhou Yangjie Electronic Technology Co., Ltd. reserves the right to make changes without notice for the specification of the products displayed herein to improve reliability, function or design or otherwise.

The product listed herein is designed to be used with ordinary electronic equipment or devices, and not designed to be used with equipment or devices which require high level of reliability and the malfunction of which would directly endanger human life (such as medical instruments, transportation equipment, aerospace machinery, nuclear-reactor controllers, fuel controllers and other safety devices), Yangjie or anyone on its behalf, assumes no responsibility or liability for any damages resulting from such improper use of sale.

This publication supersedes & replaces all information previously supplied. For additional information, please visit our website [http:// www.21yangjie.com](http://www.21yangjie.com) , or consult your nearest Yangjie's sales office for further assistance.

X-ON Electronics

Largest Supplier of Electrical and Electronic Components

Click to view similar products for [Diodes - General Purpose, Power, Switching category:](#)

Click to view products by [Yangjie manufacturer:](#)

Other Similar products are found below :

[MCL4151-TR3](#) [MMBD3004S-13-F](#) [RD0306T-H](#) [1N3611](#) [NTE156A](#) [NTE574](#) [NTE6244](#) [1SS193,LF](#) [1SS400CST2RA](#) [SDAA13](#)
[SHN2D02FUTW1T1G](#) [LS4151GS08](#) [1N4449](#) [1N456A](#) [1N4934-E3/73](#) [1N914BTR](#) [D291S45T](#) [BAV300-TR](#) [BAW56DWQ-7-F](#) [BAW75-](#)
[TAP](#) [MM230L-CAA](#) [IDW40E65D1](#) [JAN1N3600](#) [JAN1N4454UR-1](#) [LL4151-GS18](#) [SMMSD4148T3G](#) [BYW95B/A52A](#) [NSVDAN222T1G](#)
[CDSZC01100-HF](#) [LL4150-M-08](#) [1N4454-TR](#) [BAV70HDW-7](#) [BAS28-7](#) [JANTX1N6640](#) [BAW56HDW-13](#) [BAS28 TR](#) [VS-](#)
[HFA04SD60STR-M3](#) [NSVM1MA152WKT1G](#) [1SS388-TP](#) [RGP30D-E3/73](#) [VS-8EWF02S-M3](#) [BAV99TQ-13-F](#) [BAV99HDW-13](#)
[MMDB30-E28X](#) [IDP20C65D2XKSA1](#) [LS4148](#) [IDV15E65D2](#) [NSVM1MA152WAT1G](#) [HN4D02JU\(TE85L,F\)](#) [MMD820-C12](#)