

## Dual High-voltage Switching Diode



**SOT-23**

### Features

- Epoxy meets UL-94 V-0 flammability rating and halogen free
- Moisture Sensitivity Level 1
- Fast Switching Speed
- High Conductance
- Part no. with suffix "Q" means AEC-Q101 qualified

### Applications

- For General Purpose Switching Applications
- Automotive

### Mechanical Data

- Case: SOT-23
- Terminals: Tin plated leads, solderable per J-STD-002 and JESD22-B102

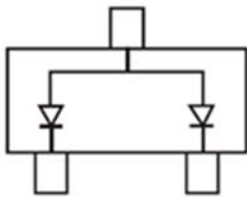

BAV23AQ Marking: KT7

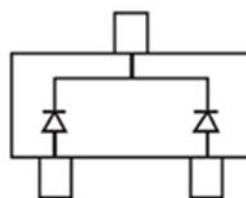

BAV23CQ Marking: KT6

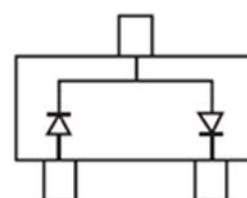

BAV23SQ Marking: KL31

### ■ Maximum Rating, ( $T_a=25^\circ\text{C}$ Unless otherwise specified)

Item	Symbol	Unit	Value
Repetitive peak reverse voltage	$V_{RRM}$	V	250
Forward Continuous Current, Per Leg	$I_{F[1]}$	mA	225
Non-Repetitive Peak Forward Surge Current@ $t_p=10\text{ms}$ ,	$I_{FSM}$	A	1.7
Power Dissipation	$P_{D[1]}$	mW	350
Thermal Resistance from Junction to Ambient	$R_{thJA}$	$^\circ\text{C}/\text{W}$	357
Operation Junction Temperature	$T_J$	$^\circ\text{C}$	-55 to +150
Storage Temperature	$T_{STG}$	$^\circ\text{C}$	-55 to +150

[1] Single diode loaded



## BAV23AQ/CQ/SQ

### ■Electrical Characteristics (T<sub>a</sub>=25°C Unless otherwise specified, Per Leg)

Item	Symbol	Unit	Conditions	Min	Typ	Max
Reverse Voltage	V <sub>BR</sub>	V	I <sub>R</sub> =100uA	250		
Forward Voltage	V <sub>F</sub>	V	I <sub>FM</sub> =100mA, T <sub>J</sub> =25°C			1
			I <sub>FM</sub> =200mA, T <sub>J</sub> =25°C			1.25
Reverse Current	I <sub>R</sub>	uA	V <sub>R</sub> =200V			0.1
Total Capacitance	C <sub>tot</sub>	pF	f=1.0MHz, V <sub>R</sub> =0V			5
Reverse Recovery Time	T <sub>rr</sub>	ns	I <sub>F</sub> =I <sub>R</sub> =30mA, V <sub>R</sub> =6V, R <sub>L</sub> =100Ω, I <sub>rr</sub> =3mA			50

### ■Ordering Information (Example)

PREFERRED P/N	PACKING CODE	UNIT WEIGHT(g)	MINIMUM PACKAGE(pcs)	INNER BOX QUANTITY(pcs)	OUTER CARTON QUANTITY(pcs)	DELIVERY MODE
BAV23AQ/CQ/SQ	F2	Approximate 0.01	3000	30000	120000	7" reel



# BAV23AQ/CQ/SQ

## ■ Typical Characteristics (Per Leg)

Fig.1:  $P_D-T_A$

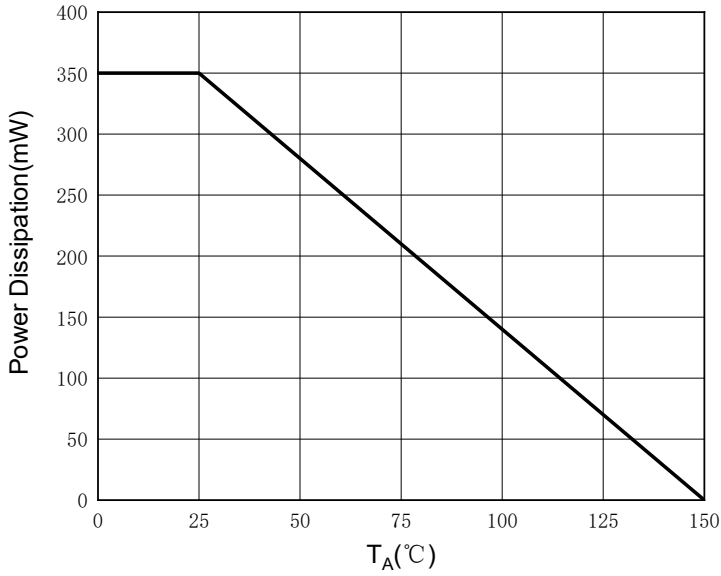

Fig.2: Forward Characteristics

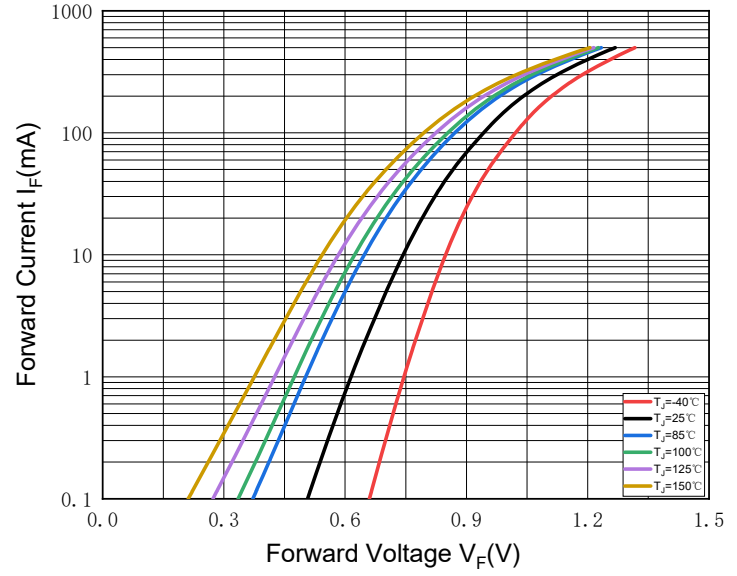

Fig.3: Reverse Characteristics

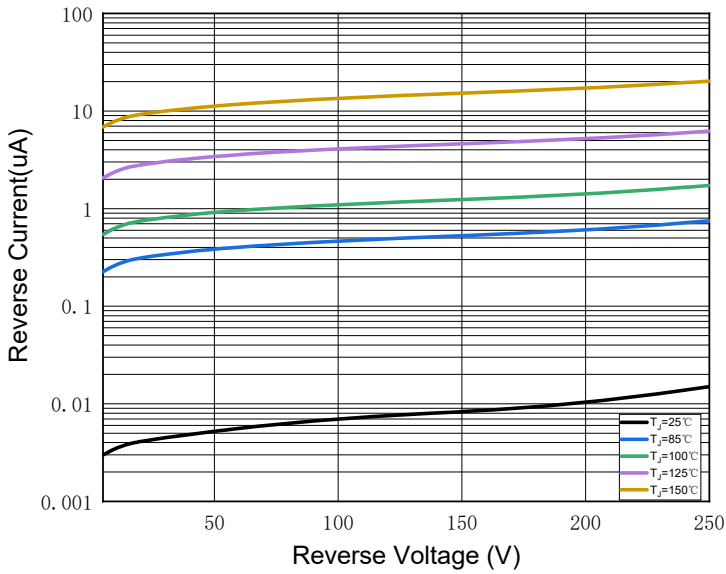
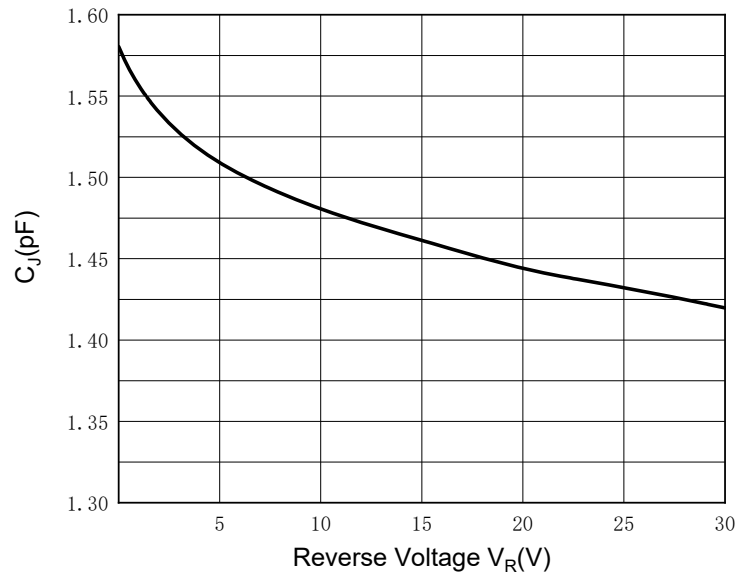

Fig.4: Capacitance Characteristics





# BAV23AQ/CQ/SQ

## ■ SOT-23 Package Outline Dimensions

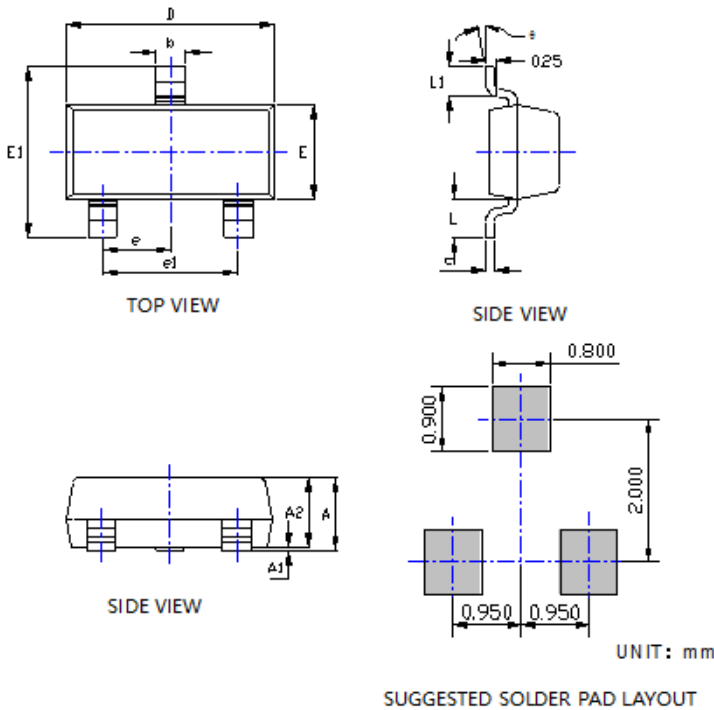

SYMBOL	DIMENSIONS			
	INCHES		Millimeter	
	MIN.	MAX.	MIN.	MAX.
A	0.035	0.045	0.900	1.150
A1	0.000	0.004	0.000	0.100
A2	0.035	0.041	0.900	1.050
b	0.012	0.020	0.300	0.500
c	0.004	0.008	0.100	0.200
D	0.110	0.118	2.800	3.000
E	0.047	0.055	1.200	1.400
E1	0.089	0.100	2.250	2.550
e	0.037TYP		0.950TYP	
e1	0.071	0.079	1.800	2.000
L	0.022REF		0.550REF	
L1	0.012	0.020	0.300	0.500
θ	0°	8°	0°	8°

NOTE:  
 1. PACKAGE BODY SIZES EXCLUDE MOLD FLASH AND GATE BURRS.  
 2. TOLERANCE 0.1mm UNLESS OTHERWISE SPECIFIED.  
 3. THE PAD LAYOUT IS FOR REFERENCE PURPOSES ONLY.

## ■ Marking Information

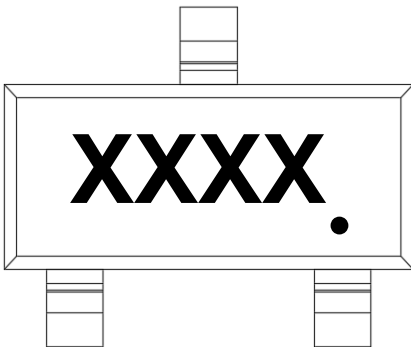

PN	Marking Code
BAV23AQ	KT7
BAV23CQ	KT6
BAV23SQ	KL31

- Note:
1. All marking is at middle of the product body
  2. All marking is in laser marking
  3. Body color: Black



## BAV23AQ/CQ/SQ

---

### Disclaimer

The information presented in this document is for reference only. Yangzhou Yangjie Electronic Technology Co., Ltd. reserves the right to make changes without notice for the specification of the products displayed herein to improve reliability, function or design or otherwise.

The product listed herein is designed to be used with automotive electronics, are not designed for use in medical, life-saving, lifesustaining, or military, Yangjie or anyone on its behalf, assumes no responsibility or liability for any damages resulting from such improper use of sale.

This publication supersedes & replaces all information previously supplied. For additional information, please visit our website [http:// www.21yangjie.com](http://www.21yangjie.com) , or consult your nearest Yangjie's sales office for further assistance.

## X-ON Electronics

Largest Supplier of Electrical and Electronic Components

*Click to view similar products for [Diodes - General Purpose, Power, Switching category](#):*

*Click to view products by [Yangjie manufacturer](#):*

Other Similar products are found below :

[MMBD3004S-13-F](#) [1N3611](#) [NTE156A](#) [NTE6244](#) [1SS400CST2RA](#) [SDAA13](#) [SHN2D02FUTW1T1G](#) [1N4449](#) [1N456A](#) [1N914BTR](#)  
[D291S45T](#) [BAS 16-02L E6327](#) [BAS 16-02V H6327](#) [BAS 21U E6327](#) [BAS 28 E6327](#) [BAW56DWQ-7-F](#) [BAW56M3T5G](#) [BAW75-TAP](#)  
[MM230L-CAA](#) [IDW40E65D1](#) [JAN1N3600](#) [JAN1N4454UR-1](#) [SMMSD4148T3G](#) [BYW95B/A52A](#) [NSVDAN222T1G](#) [CDSZC01100-HF](#)  
[BAV70HDW-7](#) [BAS28-7](#) [JANTX1N6640](#) [BAW56HDW-13](#) [BAS28 TR](#) [VS-HFA04SD60STR-M3](#) [1SS388-TP](#) [BAV99TQ-13-F](#)  
[BAV99HDW-13](#) [1N4004](#) [MMDB30-E28X](#) [LS4148](#) [IDV15E65D2](#) [W0503RH200S0L](#) [M0268SJ200NLF](#) [M0268RJ200NLF](#) [S3MBF](#) [US1J](#)  
[DAN217U-TP](#) [SHV-06JNS-Q](#) [IDW30C65D1](#) [IDW80C65D1](#) [VS-HFA30TA60CSR-M3](#) [M1MA152WAT1](#)