

## Dual Switching Diode

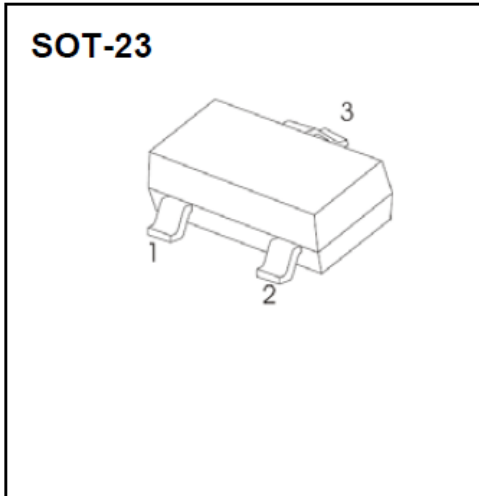

### Features

- Epoxy meets UL-94 V-0 flammability rating
- Moisure Sensitivity Level 1
- Fast Switching Speed
- High Conductance
- For General Purpose Switching Applications

BAV23A	BAV23C	BAV23S
<b>MARKING: KT7</b>	<b>MARKING: KT6</b>	<b>MARKING: KL31</b>

### ■ Maximum Rating, ( $T_a=25^{\circ}\text{C}$ Unless otherwise specified)

Item	Symbol	Unit	Value
Repetitive peak reverse voltage	$V_{RRM}$	V	250
Average Rectified Output Current	$I_o$	mA	200
Power Dissipation	$P_D$	mW	350
Thermal Resistance from Junction to Ambient	$R_{thJA}$	$^{\circ}\text{C}/\text{W}$	357
Operation Junction Temperature	$T_J$	$^{\circ}\text{C}$	-55 to +150
Storage Temperature	$T_{STG}$	$^{\circ}\text{C}$	-55 to +150

### ■ Ordering Information (Example)

PREFERED P/N	PACKING CODE	UNIT WEIGHT(g)	MINIMUM PACKAGE(pcs)	INNER BOX QUANTITY(pcs)	OUTER CARTON QUANTITY(pcs)	DELIVERY MODE
BAV23C	F2	Approximate 0.008	3000	30000	120000	7" reel



# BAV23A/C/S

## ■ Electrical Characteristics (T<sub>a</sub>=25°C Unless otherwise specified, Per Leg)

Item	Symbol	Unit	Conditions	Min	Typ	Max
Reverse Voltage	V <sub>BR</sub>	V	I <sub>R</sub> =100uA	250		
Forward Voltage	V <sub>F</sub>	V	I <sub>FM</sub> =100mA, T <sub>J</sub> =25°C			1
			I <sub>FM</sub> =200mA, T <sub>J</sub> =25°C			1.25
Reverse Current	I <sub>R</sub>	uA	V <sub>R</sub> =200V			0.1
Total Capacitance	C <sub>tot</sub>	pF	f=1.0MHz, V <sub>R</sub> =0V			5
Reverse Recovery Time	T <sub>rr</sub>	ns	I <sub>F</sub> =I <sub>R</sub> =30mA, V <sub>R</sub> =6V, R <sub>L</sub> =100Ω, I <sub>rr</sub> =3mA			50

## ■ Typical Characteristics (Per Leg)

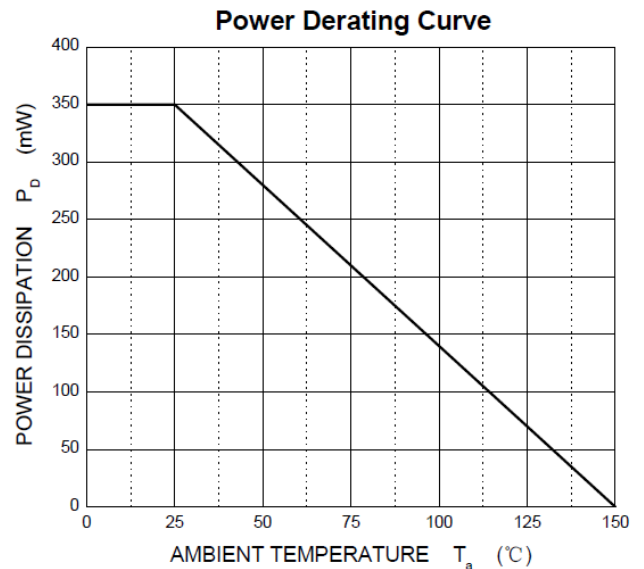
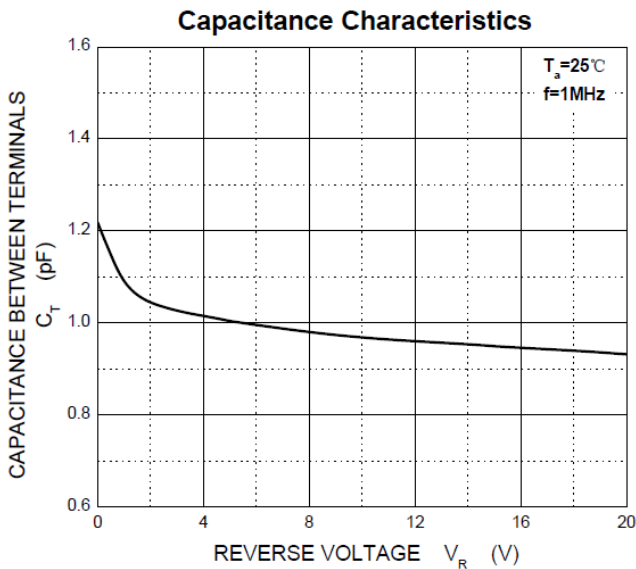
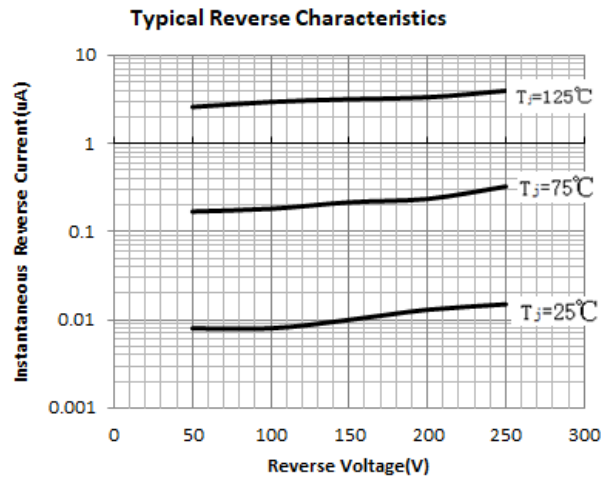
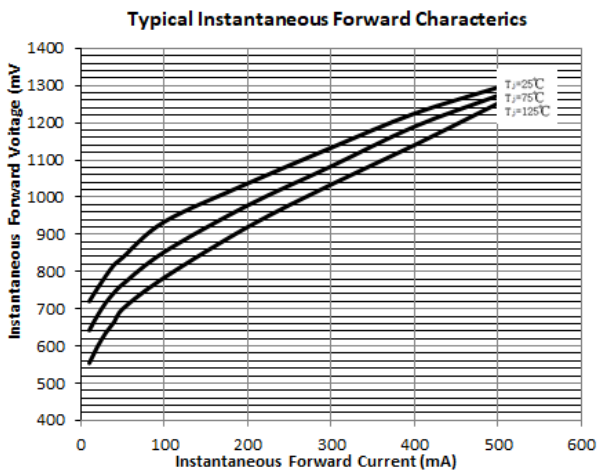



# BAV23A/C/S

## ■SOT-23 Package Outline Dimensions

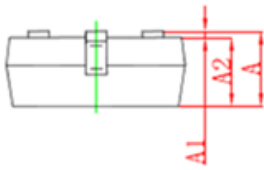
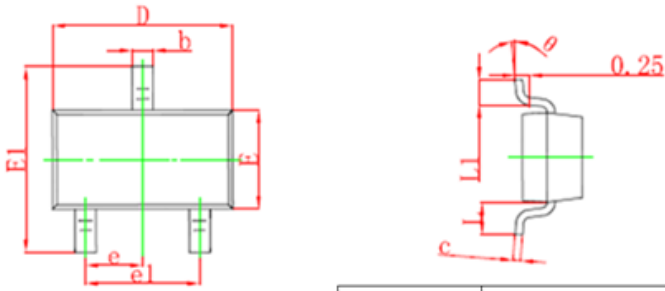

Symbol	Dimensions In Millimeters		Dimensions In Inches	
	Min	Max	Min	Max
A	0.900	1.150	0.035	0.045
A1	0.000	0.100	0.000	0.004
A2	0.900	1.050	0.035	0.041
b	0.300	0.500	0.012	0.020
c	0.100	0.200	0.004	0.008
D	2.800	3.000	0.110	0.118
E	1.200	1.400	0.047	0.055
E1	2.250	2.550	0.089	0.100
e	0.950TYP		0.037TYP	
e1	1.800	2.000	0.071	0.079
L	0.550REF		0.022REF	
L1	0.300	0.500	0.012	0.020
θ	0°		8°	

## ■SOT-23Suggested Pad Layout

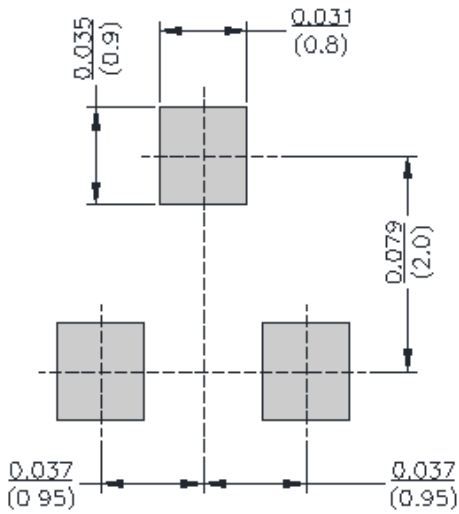



### **Disclaimer**

The information presented in this document is for reference only. Yangzhou Yangjie Electronic Technology Co., Ltd. reserves the right to make changes without notice for the specification of the products displayed herein to improve reliability, function or design or otherwise.

The product listed herein is designed to be used with ordinary electronic equipment or devices, and not designed to be used with equipment or devices which require high level of reliability and the malfunction of which would directly endanger human life (such as medical instruments, transportation equipment, aerospace machinery, nuclear-reactor controllers, fuel controllers and other safety devices), Yangjie or anyone on its behalf, assumes no responsibility or liability for any damages resulting from such improper use of sale.

This publication supersedes & replaces all information previously supplied. For additional information, please visit our website [http:// www.21yangjie.com](http://www.21yangjie.com) , or consult your nearest Yangjie's sales office for further assistance.

## X-ON Electronics

Largest Supplier of Electrical and Electronic Components

*Click to view similar products for [Diodes - General Purpose, Power, Switching category](#):*

*Click to view products by [Yangjie manufacturer](#):*

Other Similar products are found below :

[MCL4151-TR3](#) [MMBD3004S-13-F](#) [RD0306T-H](#) [1N3611](#) [NTE156A](#) [NTE574](#) [NTE6244](#) [1SS193,LF](#) [1SS400CST2RA](#) [SDAA13](#)  
[SHN2D02FUTW1T1G](#) [LS4151GS08](#) [1N4449](#) [1N456A](#) [1N4934-E3/73](#) [1N914BTR](#) [D291S45T](#) [BAV300-TR](#) [BAW56DWQ-7-F](#) [BAW75-](#)  
[TAP](#) [MM230L-CAA](#) [IDW40E65D1](#) [JAN1N3600](#) [JAN1N4454UR-1](#) [LL4151-GS18](#) [SMMSD4148T3G](#) [BYW95B/A52A](#) [NSVDAN222T1G](#)  
[CDSZC01100-HF](#) [LL4150-M-08](#) [1N4454-TR](#) [BAV70HDW-7](#) [BAS28-7](#) [JANTX1N6640](#) [BAW56HDW-13](#) [BAS28 TR](#) [VS-](#)  
[HFA04SD60STR-M3](#) [NSVM1MA152WKT1G](#) [1SS388-TP](#) [RGP30D-E3/73](#) [VS-8EWF02S-M3](#) [BAV99TQ-13-F](#) [BAV99HDW-13](#)  
[MMDB30-E28X](#) [IDP20C65D2XKSA1](#) [LS4148](#) [IDV15E65D2](#) [NSVM1MA152WAT1G](#) [HN4D02JU\(TE85L,F\)](#) [MMD820-C12](#)