

NPN General Purpose Amplifier

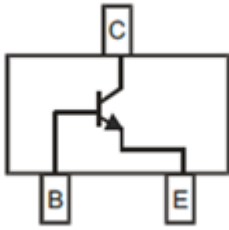

SOT-23

Features

- Epoxy meets UL-94 V-0 flammability rating and halogen free
- Moisture Sensitivity Level 1
- Part no. with suffix "Q" means AEC-Q101 qualified

Applications

- General purpose switching and amplification

Mechanical Data

- **Case:** SOT-23
- **Terminals:** Tin plated leads, solderable per J-STD-002 and JESD22-B102
- **Marking:**

BC846AQ=1A	BC847AQ=1E	BC848AQ=1J
BC846BQ=1B	BC847BQ=1F	BC848BQ=1K
	BC847CQ=1G	BC848CQ=1L

■ Maximum Ratings (Ta=25°C unless otherwise noted)

Item	Symbol	Unit	Conditions	Value	
Collector-Base Voltage	V_{CBO}	V		BC846AQ、BC846BQ	80
				BC847AQ、BC847BQ、 BC847CQ	50
				BC848AQ、BC848BQ、 BC848CQ	30
Collector-Emitter Voltage	V_{CEO}	V		BC846AQ、BC846BQ	65
				BC847AQ、BC847BQ、 BC847CQ	45
				BC848AQ、BC848BQ、 BC848CQ	30
Emitter-Base Voltage	V_{EBO}	V		6	
Collector Current -Continuous	I_C	A		0.1	
Total Device Dissipation	P_D	mW		300	
Thermal Resistance Junction to Ambient	R_{thJA}	K/W		417	
Junction Temperature	T_j	°C		150	
Storage Temperature	T_{STG}	°C		-55 to +150	



BC846Q THRU BC848Q

■ Electrical Characteristics (Ta=25°C unless otherwise noted)

Item	Symbol	Unit	Conditions		Min	Max
Collector-base breakdown voltage	$V_{(BR)CBO}$	V	BC846AQ、BC846BQ	$I_C=10\mu A, I_E=0$	80	
			BC847AQ、BC847BQ、 BC847CQ		50	
			BC848AQ、BC848BQ、 BC848CQ		30	
Collector-emitter breakdown voltage	$V_{(BR)CEO}$	V	BC846AQ、BC846BQ	$I_C=10mA, I_B=0$	65	
			BC847AQ、BC847BQ、 BC847CQ		45	
			BC848AQ、BC848BQ、 BC848CQ		30	
Emitter-base breakdown voltage	$V_{(BR)EBO}$	V	$I_E=10\mu A, I_C=0$		6	
Collector cut-off current	I_{CBO}	nA	BC846AQ、BC846BQ	$V_{CB}=70V, I_E=0$		100
			BC847AQ、BC847BQ、 BC847CQ	$V_{CB}=50V, I_E=0$		
			BC848AQ、BC848BQ、 BC848CQ	$V_{CB}=30V, I_E=0$		
Collector cut-off current	I_{CEO}	nA	BC846AQ、BC846BQ	$V_{CE}=60V, I_B=0$		100
			BC847AQ、BC847BQ、 BC847CQ	$V_{CE}=45V, I_B=0$		
			BC848AQ、BC848BQ、 BC848CQ	$V_{CE}=30V, I_B=0$		
Emitter cut-off current	I_{EBO}	nA	$V_{EB}=5V, I_C=0$			100
DC current gain	h_{FE}		BC846AQ、BC847AQ、 BC848AQ	$V_{CE}=5.0V, I_C=2mA$	110	220
			BC846BQ、BC847BQ、 BC848BQ		200	450
			BC847CQ、BC848CQ		420	800
Collector-emitter saturation voltage	$V_{CE(sat)}$	V	$I_C=100mA, I_B=5mA$			0.5
Base-emitter saturation voltage	$V_{BE(sat)}$	V	$I_C=100mA, I_B=5mA$			1.1
Transition frequency	f_T	MHz	$V_{CE}=5Vdc, I_C=10mA, f=30MHz$		150	
Collector output capacitance	Cob	pF	$V_{CB}=10V, f=1MHz$			4.5

■ Ordering Information (Example)

PREFERRED P/N	PACKING CODE	UNIT WEIGHT(g)	MINIMUM PACKAGE(pcs)	INNER BOX QUANTITY(pcs)	OUTER CARTON QUANTITY(pcs)	DELIVERY MODE
BC846AQ、BC846BQ BC847AQ、BC847BQ、BC847CQ BC848AQ、BC848BQ、BC848CQ	F2	Approximate 0.01	3000	30000	120000	7" reel



BC846Q THRU BC848Q

■ Characteristics (Typical-BC846AQ)

Static Characteristics

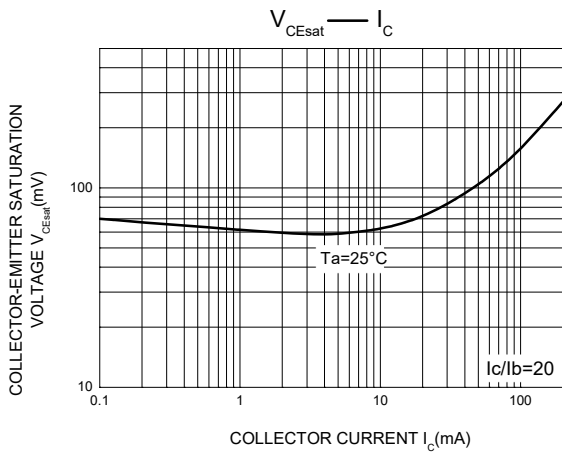
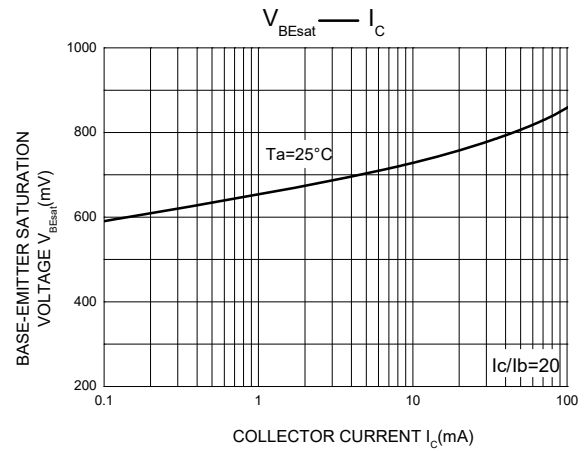
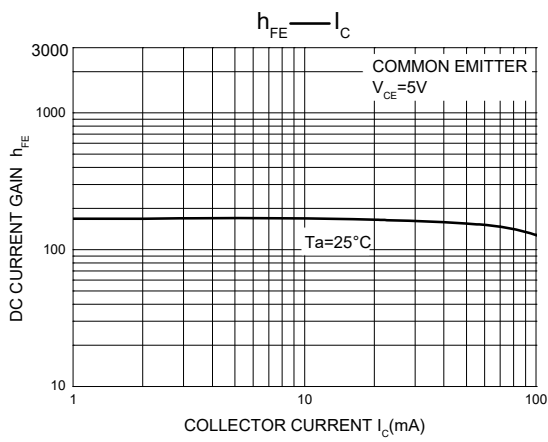
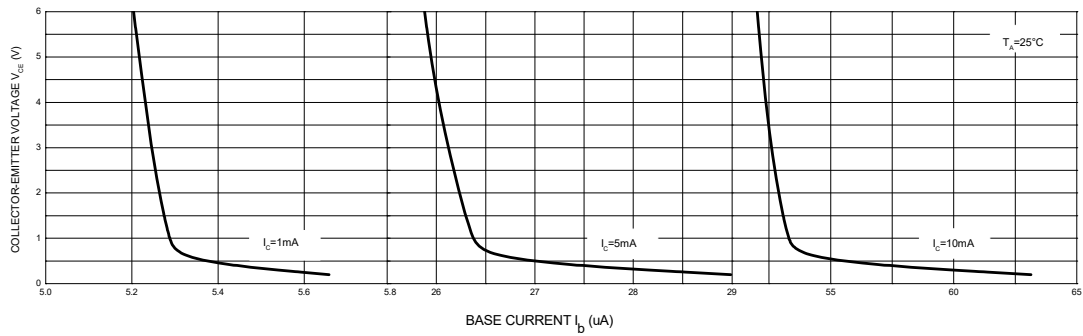



BC846Q THRU BC848Q

■SOT-23 Package Outline Dimensions

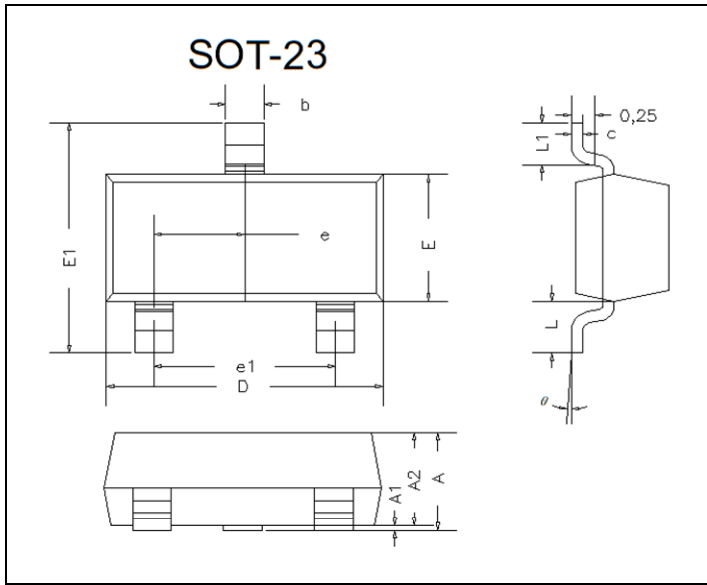

DIM	INCHES		MM		NOTE
	MIN	MAX	MIN	MAX	
A	0.035	0.045	0.90	1.15	
A1	0.000	0.004	0.00	0.10	
A2	0.035	0.041	0.90	1.05	
b	0.012	0.020	0.30	0.50	
c	0.004	0.008	0.10	0.20	
D	0.110	0.118	2.80	3.00	
E	0.047	0.055	1.20	1.40	
E1	0.089	0.100	2.25	2.55	
e	0.370TYP		0.95TYP		
e1	0.071	0.079	1.80	2.00	
L	0.220REF		0.55REF		
L1	0.012	0.020	0.30	0.50	
θ	0°	8°	0°	8°	

■SOT-23 Suggested Pad Layout

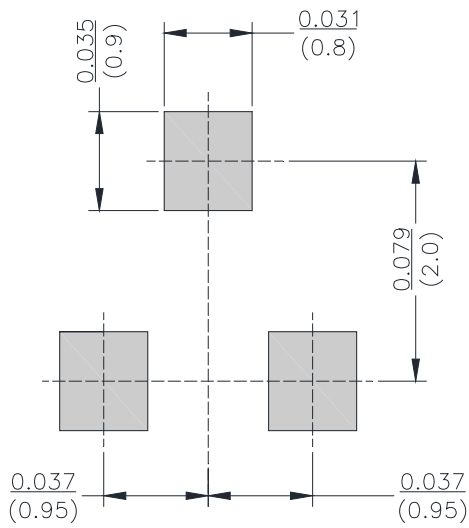

Unit: $\frac{\text{inch}}{\text{mm}}$



BC846Q THRU BC848Q

Disclaimer

The information presented in this document is for reference only. Yangzhou Yangjie Electronic Technology Co., Ltd. reserves the right to make changes without notice for the specification of the products displayed herein to improve reliability, function or design or otherwise.

The product listed herein is designed to be used with automotive electronics, are not designed for use in medical, life-saving, lifesustaining, or military, Yangjie or anyone on its behalf, assumes no responsibility or liability for any damages resulting from such improper use of sale.

This publication supersedes & replaces all information previously supplied. For additional information, please visit our website [http:// www.21yangjie.com](http://www.21yangjie.com) , or consult your nearest Yangjie's sales office for further assistance.

X-ON Electronics

Largest Supplier of Electrical and Electronic Components

Click to view similar products for [Bipolar Transistors - BJT category](#):

Click to view products by [Yangjie manufacturer](#):

Other Similar products are found below :

[BC559C](#) [MCH4017-TL-H](#) [MMBT-2369-TR](#) [BC546/116](#) [NJVMJD148T4G](#) [NTE16](#) [NTE195A](#) [IMX9T110](#) [2N4401-A](#) [2N4403](#) [2N6728](#)
[2SA1419T-TD-H](#) [2SA2126-E](#) [2SB1204S-TL-E](#) [FMC5AT148](#) [2N2369ADCSM](#) [2N2907A](#) [2N3904-NS](#) [2N5769](#) [2SC4618TLN](#) [CPH6501-](#)
[TL-E](#) [MCH4021-TL-E](#) [Jantx2N5416](#) [US6T6TR](#) [BAX18/A52R](#) [BC556/112](#) [IMZ2AT108](#) [MMST8098T146](#) [UMX21NTR](#) [MCH6102-TL-E](#)
[TTA1452B,S4X\(S](#) [2N3879](#) [NTE13](#) [NTE282](#) [NTE323](#) [NTE350](#) [NTE81](#) [JANTX2N2920L](#) [JANTX2N3735](#) [JANSR2N2222AUB](#)
[CMLT3946EG TR](#) [SNSS40600CF8T1G](#) [CMLT3906EG TR](#) [GRP-DATA-JANS2N2907AUB](#) [GRP-DATA-JANS2N2222AUA](#)
[MMDT3946FL3-7](#) [2N4240](#) [MSB30KH-13](#) [2N2221AUB](#) [2SD1815T-TL-E](#)