

## Small Signal Zener Diodes

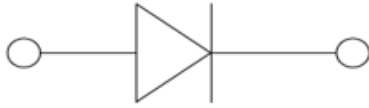

**SOD323**

### Features

- Epoxy meets UL-94 V-0 flammability rating and halogen free
- Moisture Sensitivity Level 1
- Zener Voltage 3.6V~36V
- $V_z$ -tolerance  $\pm 2\%$  approximately
- ESD Rating of Class 3 ( $> 16$  kV) per Human Body Model
- Part no. with suffix "Q" means AEC-Q101 qualified

### Applications

- General regulation functions

### Mechanical Data

- **Case:** SOD323
- **Terminals:** Tin plated leads, solderable per J-STD-002 and JESD22-B102
- **Polarity:** Cathode line denotes the cathode end

### ■ Maximum Ratings ( $T_a=25^\circ\text{C}$ Unless otherwise specified)

PARAMETER	SYMBOL	UNIT	VALUE
Power Dissipation	$P_D^{(1)}$	mW	300
			$\leq 2.4$ mW/ $^\circ\text{C}$ (Derate above $25^\circ\text{C}$ )
Storage Temperature Range	$T_{stg}$	$^\circ\text{C}$	-55~+150
Junction Temperature	$T_J$	$^\circ\text{C}$	-55~+150
Maximum Regulator Current	$I_{ZM}$	mA	$P_D / V_z$
Maximum Forward Voltage ( $I_F=10\text{mA}_{dc}$ )	$V_F$	V	0.9
Thermal Resistance Junction to Ambient Air*	$R_{thJA}^{(1)}$	$^\circ\text{C} / \text{W}$	415

(1) Device mounted on an FR4 PCB (1.0 x 1.0 x 0.06 inch), single-sided copper, tin-plated and standard footprint.

### ■ Ordering Information (Example)

PREFERRED P/N	PACKING CODE	UNIT WEIGHT(g)	MINIMUM PACKAGE(pcs)	INNER BOX QUANTITY(pcs)	OUTER CARTON QUANTITY(pcs)	DELIVERY MODE
BZT52B3V6SQ THRU BZT52B36SQ	F2	Approximate 0.0045	3000	30000	120000	7" reel



# BZT52B3V6SQ THRU BZT52B36SQ

## ■ Electrical Characteristics (T<sub>a</sub>=25°C Unless otherwise specified)

Type Number	Device Marking	V <sub>z</sub> at I <sub>zt</sub> (V)			I <sub>zt</sub>	Z <sub>zt</sub> (Ω)		Z <sub>zk</sub> (Ω)		I <sub>R</sub> (μA)@V <sub>R</sub>		Typical Temperature Coefficient@ I <sub>ZTC</sub> mV/°C		Test Current I <sub>ZTC</sub>
		min.	typ.	max.	mA	I <sub>zt</sub> (mA)	max.	I <sub>zk</sub> (mA)	max.	uA	V <sub>R</sub> (V)	Min	Max	mA
BZT52B3V6SQ	2W4	3.53	3.6	3.67	5	5	90	1.0	600	5	1.0	-3.5	0	5
BZT52B3V9SQ	2W5	3.82	3.9	3.98	5	5	90	1.0	600	3	1.0	-3.5	0	5
BZT52B4V3SQ	2W6	4.21	4.3	4.39	5	5	90	1.0	600	3	1.0	-3.5	0	5
BZT52B4V7SQ	2W7	4.61	4.7	4.79	5	5	80	1.0	500	3	2.0	-3.5	0.2	5
BZT52B5V1SQ	2W8	5.0	5.1	5.2	5	5	60	1.0	480	2	2.0	-2.7	1.2	5
BZT52B5V6SQ	2W9	5.49	5.6	5.71	5	5	40	1.0	400	1	2.0	-2	2.5	5
BZT52B6V2SQ	2WA	6.08	6.2	6.32	5	5	10	1.0	150	3	4.0	0.4	3.7	5
BZT52B6V8SQ	2WB	6.66	6.8	6.94	5	5	15	1.0	80	2	4.0	1.2	4.5	5
BZT52B7V5SQ	2WC	7.35	7.5	7.65	5	5	15	1.0	80	1	5.0	2.5	5.3	5
BZT52B8V2SQ	2WD	8.04	8.2	8.36	5	5	15	1.0	80	0.7	5.0	3.2	6.2	5
BZT52B9V1SQ	2WE	8.92	9.1	9.28	5	5	15	1.0	100	0.5	6.0	3.8	7.0	5
BZT52B10SQ	WG	9.8	10	10.2	5	5	20	1.0	150	0.2	7.0	4.5	8.0	5
BZT52B11SQ	2WG	10.78	11	11.22	5	5	20	1.0	150	0.1	8.0	5.4	9.0	5
BZT52B12SQ	WI	11.76	12	12.24	5	5	25	1.0	150	0.1	8.0	6.0	10.0	5
BZT52B13SQ	2WI	12.74	13	13.3	5	5	30	1.0	170	0.1	8.0	7.0	11.0	5
BZT52B15SQ	WL	14.7	15	15.3	5	5	30	1.0	200	0.1	10.5	9.2	13.0	5
BZT52B16SQ	WM	15.68	16	16.3	5	5	40	1.0	200	0.1	11.2	10.4	14.0	5
BZT52B18SQ	WN	17.6	18	18.4	5	5	45	1.0	225	0.1	12.6	12.4	16.0	5
BZT52B20SQ	2WM	19.6	20	20.4	5	5	55	1.0	225	0.1	14.0	14.4	18.0	5
BZT52B22SQ	2WN	21.56	22	22.44	5	5	55	1.0	250	0.1	15.4	16.4	20.0	5
BZT52B24SQ	WR	23.52	24	24.5	5	5	70	1.0	250	0.1	16.8	18.4	22.0	5
BZT52B27SQ	2WP	26.46	27	27.54	2	2	80	0.5	300	0.1	18.9	21.4	25.3	2
BZT52B30SQ	2WQ	29.4	30	30.6	2	2	80	0.5	300	0.1	21.0	24.4	29.4	2
BZT52B33SQ	2WR	32.34	33	33.7	2	2	80	0.5	325	0.1	23.1	27.4	33.4	2
BZT52B36SQ	2WS	35.28	36	36.72	2	2	90	0.5	350	0.1	25.2	30.4	37.4	2



# BZT52B3V6SQ THRU BZT52B36SQ

## ■ Characteristics (Typical)

ZENER BREAKDOWN CHARACTERISTICS

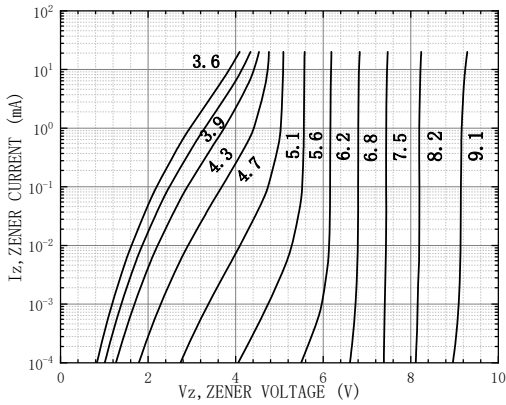

ZENER BREAKDOWN CHARACTERISTICS

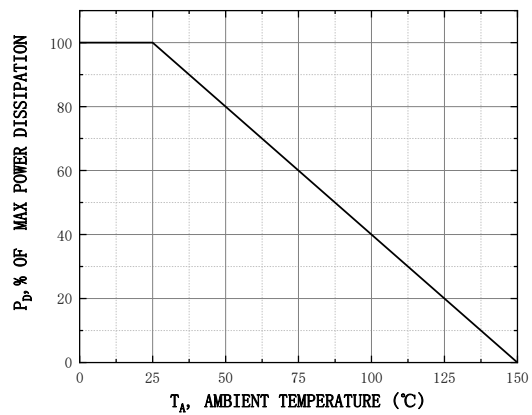
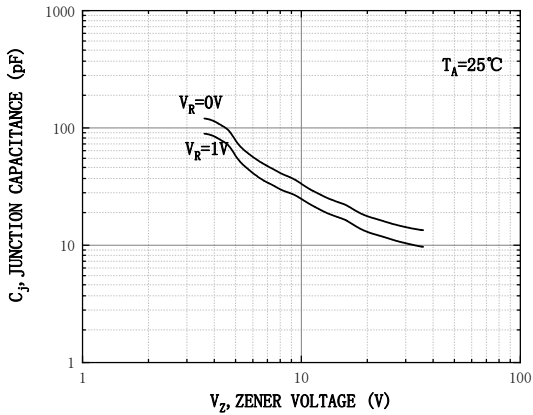
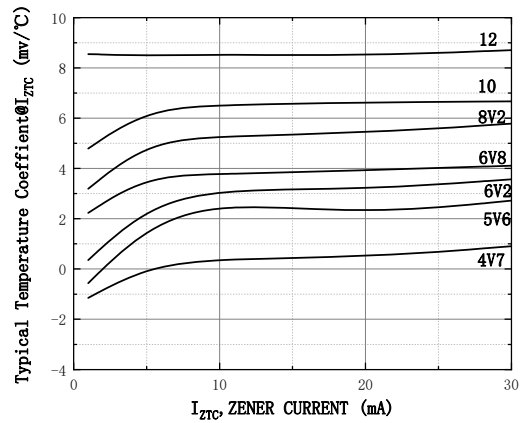
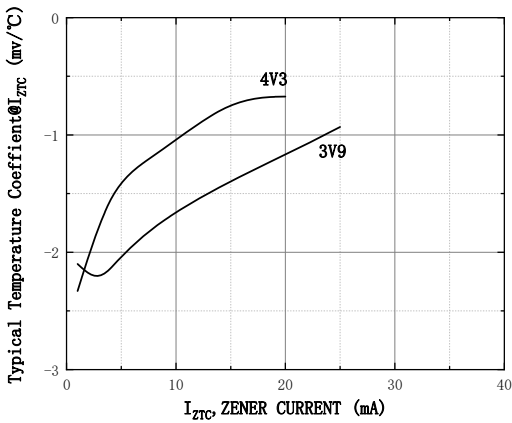
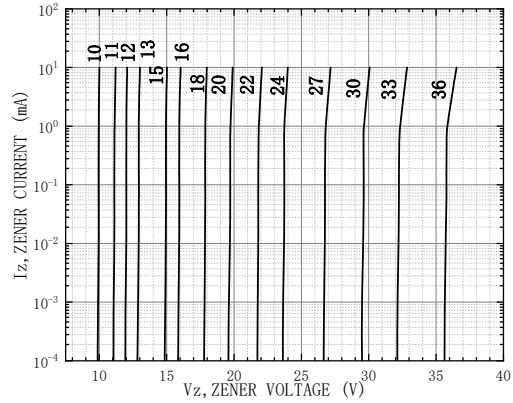



# BZT52B3V6SQ THRU BZT52B36SQ

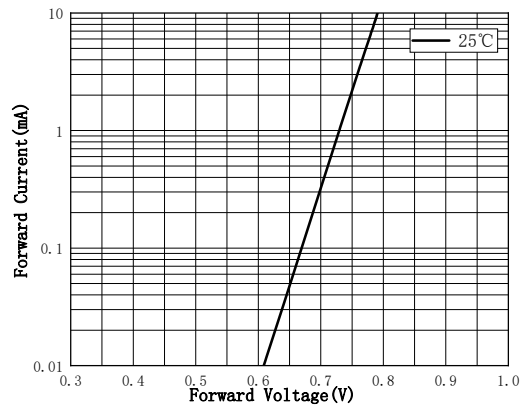
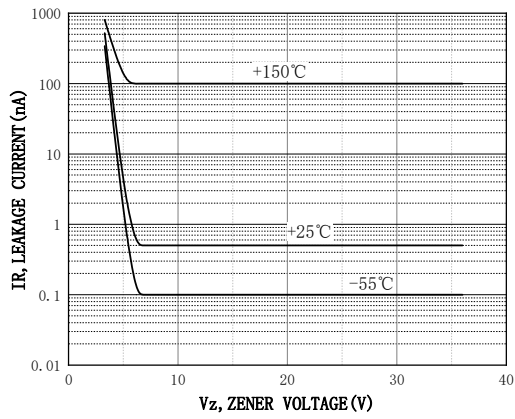



# BZT52B3V6SQ THRU BZT52B36SQ

## ■ Outline Dimensions

SOD-323

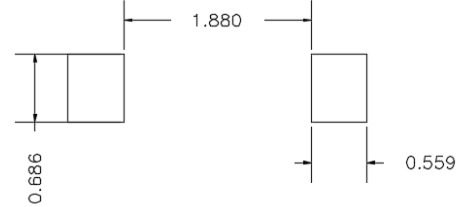
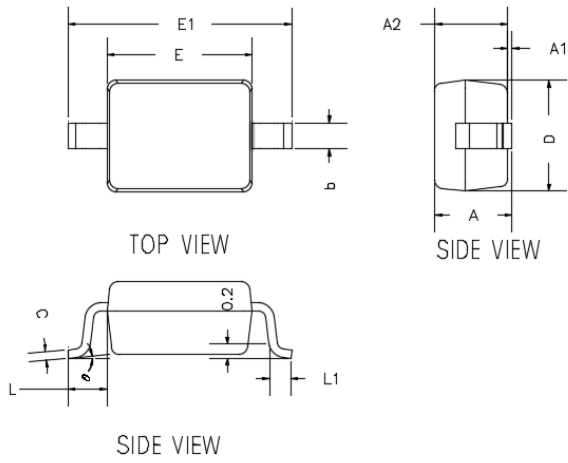

UNIT: mm

SUGGESTED SOLDER PAD LAYOUT

DIMENSIONS				
DIM	INCHES		MM	
	MIN	MAX	MIN	MAX
A	---	0.0393	---	1.0000
A1	0.0000	0.0039	0.0000	0.1000
A2	0.0314	0.0354	0.8000	0.9000
b	0.0098	0.0157	0.2500	0.4000
c	0.0031	0.0059	0.0800	0.1500
D	0.0472	0.0551	1.2000	1.4000
E	0.0629	0.0709	1.6000	1.8000
E1	0.0984	0.1063	2.5000	2.7000
L	0.0187TYP		0.475TYP	
L1	0.0098	0.0157	0.250	0.400
θ	0°	8°	0°	8°

## ■ Marking Information



Note:

1. All marking is at middle of the product body
2. All marking is in laser marking
3. XX is Marking Code
4. Body color: Black



## BZT52B3V6SQ THRU BZT52B36SQ

---

### Disclaimer

The information presented in this document is for reference only. Yangzhou Yangjie Electronic Technology Co., Ltd. reserves the right to make changes without notice for the specification of the products displayed herein to improve reliability, function or design or otherwise.

The product listed herein is designed to be used with automotive electronics, are not designed for use in medical, life-saving, lifesustaining, or military, Yangjie or anyone on its behalf, assumes no responsibility or liability for any damages resulting from such improper use of sale.

This publication supersedes & replaces all information previously supplied. For additional information, please visit our website [http:// www.21yangjie.com](http://www.21yangjie.com) , or consult your nearest Yangjie's sales office for further assistance.

## X-ON Electronics

Largest Supplier of Electrical and Electronic Components

*Click to view similar products for [Zener Diodes](#) category:*

*Click to view products by [Yangjie](#) manufacturer:*

Other Similar products are found below :

[RKZ13B2KG#P1](#) [DL5234B](#) [1N4682](#) [1N4693](#) [1N4732A](#) [1N4736A](#) [1N4750A](#) [1N4759ARL](#) [1N5241B](#) [1N5365B](#) [1N5369B](#) [1N747A](#)  
[1N964B](#) [1N966B](#) [1N968B](#) [1N972B](#) [JANS1N4974US](#) [JANTX1N5907](#) [1N4692](#) [1N4702](#) [1N4704](#) [1N4711](#) [1N4714](#) [1N4745ARL](#)  
[1N4752ARL](#) [1N4760ARL](#) [1N5221B](#) [1N5242BTR](#) [1N5350B](#) [1N5352B](#) [1N961BRR1](#) [1N964BRL](#) [RKZ5.1BKU#P6](#) [3SMAJ5946B-TP](#)  
[3SMAJ5950B-TP](#) [MMSZ5230BQ-13-F](#) [MMSZ5232BQ-13-F](#) [BZX84C7V5](#) [3SMAJ5945B-TP](#) [3SMAJ5947B-TP](#) [3SMBJ5941B-TP](#)  
[DZ2S240M0L](#) [SMAZ27-TP](#) [ZMM5224B-7](#) [RD16UM-T1-A](#) [RD10S-T1-A](#) [CDZT2R5.6B](#) [1N4762A G](#) [Z1SMA18](#) [JANTX1N4553B](#)