

## Small Signal Zener Diodes

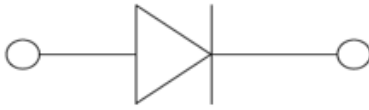

**SOD323**

### Features

- Epoxy meets UL-94 V-0 flammability rating and halogen free
- Moisture Sensitivity Level 1
- Zener Voltage 2.4V~47V
- $V_z$ -tolerance  $\pm 5\%$  approximately
- Part no. with suffix "Q" means AEC-Q101 qualified

### Applications

- General regulation functions
- Automotive

### Mechanical Data

- **Case:** SOD323
- **Terminals:** Tin plated leads, solderable per J-STD-002 and JESD22-B102
- **Polarity:** Cathode line denotes the cathode end

### ■ Maximum Ratings ( $T_a=25^\circ\text{C}$ Unless otherwise specified)

PARAMETER	SYMBOL	UNIT	VALUE
Power Dissipation	$P_D$	mW	300
Storage Temperature Range	$T_{stg}$	$^\circ\text{C}$	-55~+150
Junction Temperature	$T_J$	$^\circ\text{C}$	-55~+150
Maximum Regulator Current	$I_{ZM}$	mA	$P_D / V_z$
Maximum Forward Voltage (IF=10mA <sub>dc</sub> )	$V_F$	V	0.9
Thermal Resistance Junction to Ambient Air*	$R_{\theta JA}$	$^\circ\text{C} / \text{W}$	415

### ■ Ordering Information (Example)

PREFERRED P/N	PACKING CODE	UNIT WEIGHT(g)	MINIMUM PACKAGE(pcs)	INNER BOX QUANTITY(pcs)	OUTER CARTON QUANTITY(pcs)	DELIVERY MODE
BZT52C2V4SQ THRU BZT52C47SQ	F2	Approximate 0.0045	3000	30000	120000	7" reel



# BZT52C2V4SQ THRU BZT52C47SQ

## ■ Electrical Characteristics (T<sub>a</sub>=25°C Unless otherwise specified)

Type Number	Device Marking	V <sub>z</sub> at I <sub>zt</sub> (V)			I <sub>zt</sub> mA	Z <sub>zt</sub> (Ω)		Z <sub>zk</sub> (Ω)		I <sub>R</sub> (μA)@V <sub>R</sub>		Typical Temperature Coefficient@ I <sub>ZTC</sub> mV/°C		Test Current I <sub>ZTC</sub> mA
		min.	typ.	max.		I <sub>zt</sub> (mA)	max.	I <sub>zk</sub> (mA)	max.	uA	V <sub>R</sub> (V)	Min	Max	
BZT52C2V4SQ	WX	2.28	2.4	2.56	5	5	100	1.0	600	50	1.0	-3.5	0	5
BZT52C2V7SQ	W1	2.5	2.7	2.9	5	5	100	1.0	600	20	1.0	-3.5	0	5
BZT52C3V0SQ	W2	2.8	3.0	3.2	5	5	95	1.0	600	10	1.0	-3.5	0	5
BZT52C3V3SQ	W3	3.1	3.3	3.5	5	5	95	1.0	600	5	1.0	-3.5	0	5
BZT52C3V6SQ	W4	3.4	3.6	3.8	5	5	90	1.0	600	5	1.0	-3.5	0	5
BZT52C3V9SQ	W5	3.7	3.9	4.1	5	5	90	1.0	600	3	1.0	-3.5	0	5
BZT52C4V3SQ	W6	4.0	4.3	4.6	5	5	90	1.0	600	3	1.0	-3.5	0	5
BZT52C4V7SQ	W7	4.4	4.7	5.0	5	5	80	1.0	500	3	2.0	-3.5	0.2	5
BZT52C5V1SQ	W8	4.8	5.1	5.4	5	5	60	1.0	480	2	2.0	-2.7	1.2	5
BZT52C5V6SQ	W9	5.2	5.6	6.0	5	5	40	1.0	400	1	2.0	-2	2.5	5
BZT52C6V2SQ	WA	5.8	6.2	6.6	5	5	10	1.0	150	3	4.0	0.4	3.7	5
BZT52C6V8SQ	WB	6.4	6.8	7.2	5	5	15	1.0	80	2	4.0	1.2	4.5	5
BZT52C7V5SQ	WC	7.0	7.5	7.9	5	5	15	1.0	80	1	5.0	2.5	5.3	5
BZT52C8V2SQ	WD	7.7	8.2	8.7	5	5	15	1.0	80	0.7	5.0	3.2	6.2	5
BZT52C9V1SQ	WE	8.5	9.1	9.6	5	5	15	1.0	100	0.5	6.0	3.8	7.0	5
BZT52C10SQ	WF	9.4	10	10.6	5	5	20	1.0	150	0.2	7.0	4.5	8.0	5
BZT52C11SQ	WG	10.4	11	11.6	5	5	20	1.0	150	0.1	8.0	5.4	9.0	5
BZT52C12SQ	WH	11.4	12	12.7	5	5	25	1.0	150	0.1	8.0	6.0	10.0	5
BZT52C13SQ	WI	12.4	13	14.1	5	5	30	1.0	170	0.1	8.0	7.0	11.0	5
BZT52C15SQ	WJ	13.8	15	15.6	5	5	30	1.0	200	0.1	10.5	9.2	13.0	5
BZT52C16SQ	WK	15.3	16	17.1	5	5	40	1.0	200	0.1	11.2	10.4	14.0	5
BZT52C18SQ	WL	16.8	18	19.1	5	5	45	1.0	225	0.1	12.6	12.4	16.0	5
BZT52C20SQ	WM	18.8	20	21.2	5	5	55	1.0	225	0.1	14.0	14.4	18.0	5
BZT52C22SQ	WN	20.8	22	23.3	5	5	55	1.0	250	0.1	15.4	16.4	20.0	5
BZT52C24SQ	WO	22.8	24	25.6	5	5	70	1.0	250	0.1	16.8	18.4	22.0	5
BZT52C27SQ	WP	25.1	27	28.9	2	2	80	0.5	300	0.1	18.9	21.4	25.3	2
BZT52C30SQ	WQ	28	30	32	2	2	80	0.5	300	0.1	21.0	24.4	29.4	2
BZT52C33SQ	WR	31	33	35	2	2	80	0.5	325	0.1	23.1	27.4	33.4	2
BZT52C36SQ	WS	34	36	38	2	2	90	0.5	350	0.1	25.2	30.4	37.4	2
BZT52C39SQ	WT	37	39	41	2	2	130	0.5	350	0.1	27.3	33.4	41.2	2
BZT52C43SQ	WU	40	43	46	2	2	100	0.5	700	0.1	32	37.6	50.6	2
BZT52C47SQ	WV	44	47	50	2	2	100	0.5	750	0.1	35	42.0	55.8	2



# BZT52C2V4SQ THRU BZT52C47SQ

## ■ Characteristics (Typical)

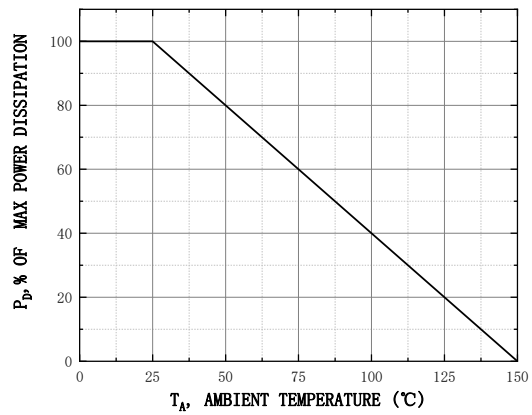
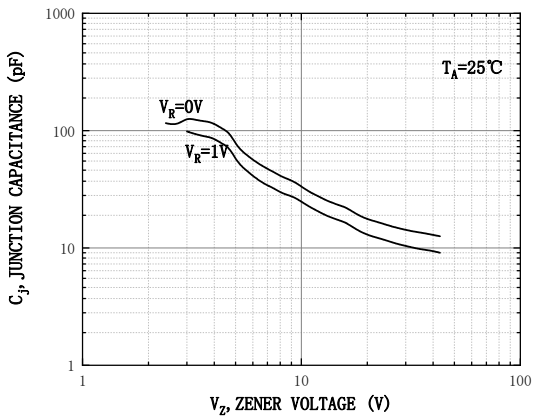
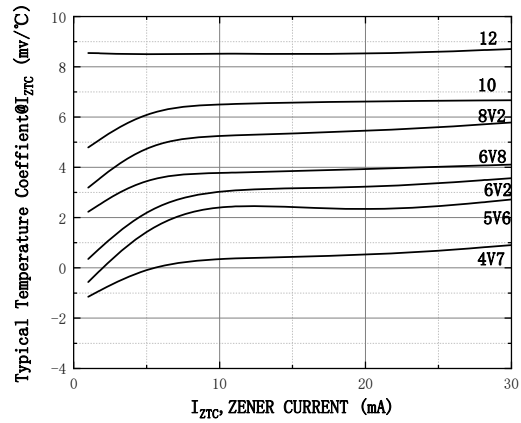
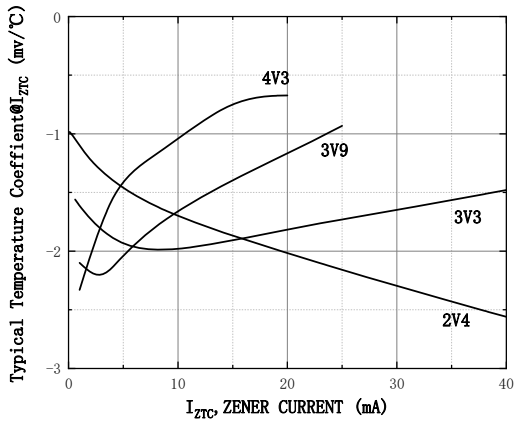
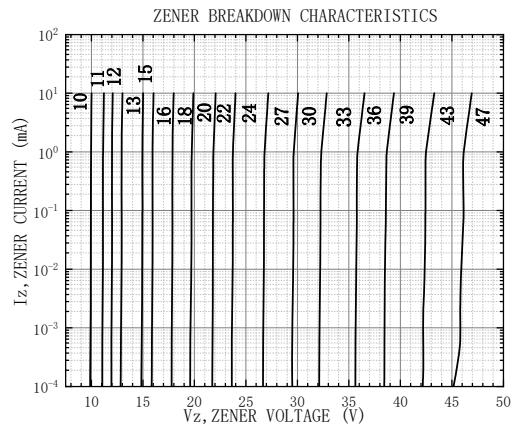
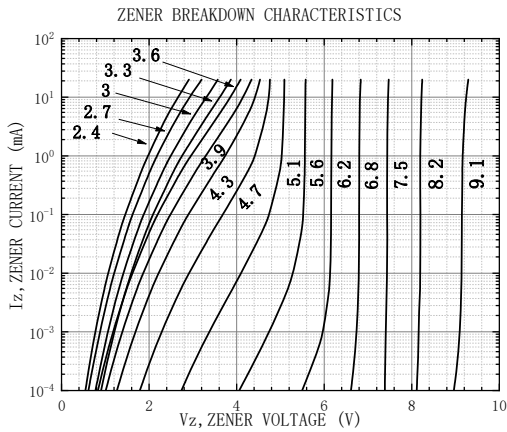



# BZT52C2V4SQ THRU BZT52C47SQ

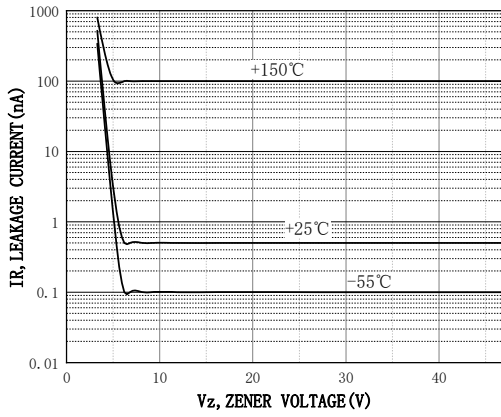



# BZT52C2V4SQ THRU BZT52C47SQ

## ■ Outline Dimensions

SOD-323

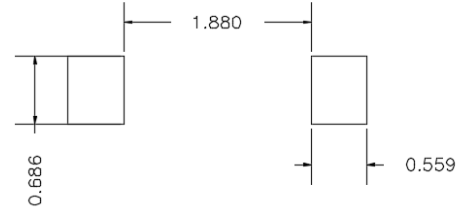
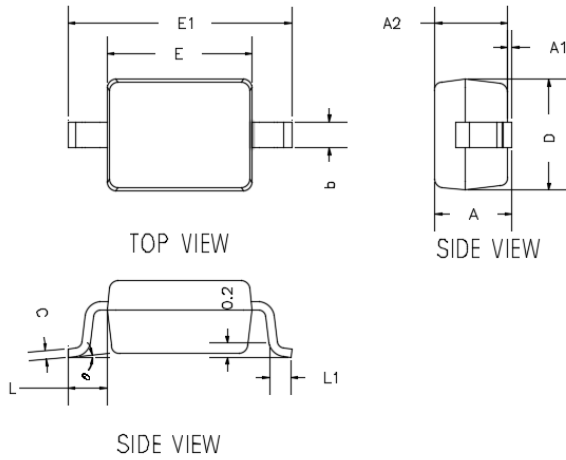

UNIT : mm

SUGGESTED SOLDER PAD LAYOUT

DIMENSIONS				
DIM	INCHES		MM	
	MIN	MAX	MIN	MAX
A	---	0.0393	---	1.0000
A1	0.0000	0.0039	0.0000	0.1000
A2	0.0314	0.0354	0.8000	0.9000
b	0.0098	0.0157	0.2500	0.4000
c	0.0031	0.0059	0.0800	0.1500
D	0.0472	0.0551	1.2000	1.4000
E	0.0629	0.0709	1.6000	1.8000
E1	0.0984	0.1063	2.5000	2.7000
L	0.0187TYP		0.475TYP	
L1	0.0098	0.0157	0.250	0.400
θ	0°	8°	0°	8°

## ■ Marking Information



Note:

1. All marking is at middle of the product body
2. All marking is in laser marking
3. XX is Marking Code
4. Body color: Black



## BZT52C2V4SQ THRU BZT52C47SQ

---

### Disclaimer

The information presented in this document is for reference only. Yangzhou Yangjie Electronic Technology Co., Ltd. reserves the right to make changes without notice for the specification of the products displayed herein to improve reliability, function or design or otherwise.

The product listed herein is designed to be used with automotive electronics, are not designed for use in medical, life-saving, lifesustaining, or military, Yangjie or anyone on its behalf, assumes no responsibility or liability for any damages resulting from such improper use of sale.

This publication supersedes & replaces all information previously supplied. For additional information, please visit our website [http:// www.21yangjie.com](http://www.21yangjie.com) , or consult your nearest Yangjie's sales office for further assistance.

## X-ON Electronics

Largest Supplier of Electrical and Electronic Components

*Click to view similar products for [Zener Diodes](#) category:*

*Click to view products by [Yangjie](#) manufacturer:*

Other Similar products are found below :

[RKZ13B2KG#P1](#) [DL5234B](#) [1N4682](#) [1N4750A](#) [1N5241B](#) [1N5365B](#) [1N5369B](#) [1N747A](#) [1N964B](#) [1N966B](#) [1N972B](#) [JANS1N4974US](#)  
[JANTX1N5907](#) [1N5242BTR](#) [1N5350B](#) [1N5352B](#) [1N961BRR1](#) [1N964BRL](#) [RKZ5.1BKU#P6](#) [3SMAJ5946B-TP](#) [3SMAJ5950B-TP](#)  
[MMSZ5230BQ-13-F](#) [MMSZ5232BQ-13-F](#) [BZX84C7V5](#) [3SMAJ5945B-TP](#) [3SMAJ5947B-TP](#) [3SMBJ5941B-TP](#) [DZ2S240M0L](#) [SMAZ27-](#)  
[TP](#) [ZMM5224B-7](#) [RD16UM-T1-A](#) [RD10S-T1-A](#) [CDZT2R5.6B](#) [Z1SMA18](#) [JANTX1N4553B](#) [SMB01-20](#) [RD3.9S-T1-A](#) [GRP-DATA-](#)  
[JANS1N4471US](#) [1N969B](#) [3SMAJ5954B-TP](#) [1N963A](#) [1N981B](#) [DFLZ5V6Q-7](#) [1N967B](#) [1N979B](#) [1N978B](#) [3SMBJ5922B-TP](#) [1N970B](#)  
[MMBZ5230B-TP](#) [12B-100](#)