

## Zener Diode

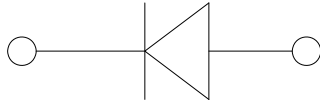
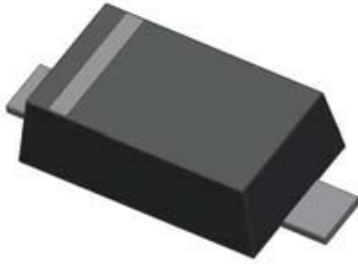

### Features

- High reliability
- Very sharp reverse characteristic
- Low reverse current level
- Zener Voltage 2.4V~36V

### Mechanical Data

- **Package:** SOD523
- **Terminals:** Tin plated leads, solderable per J-STD-002 and JESD22-B102
- **Polarity:** Cathode line denotes the cathode end

### ■ Maximum Ratings (Ta=25°C Unless otherwise specified)

PARAMETER	SYMBOL	UNIT	VALUE
Power Dissipation at Ta=25°C	P <sub>D</sub>	mW	200
Storage Temperature Range	T <sub>stg</sub>	°C	-55~+150
Maximum Junction Temperature	T <sub>J</sub>	°C	-55~+150
Maximum Regulator Current	I <sub>ZM</sub>	mA	P <sub>D</sub> /V <sub>Z</sub>
Forward Voltage(@10mA)	V <sub>F</sub>	V	1.0
Thermal Resistance Junction to Ambient Air*	R <sub>θJA</sub>	°C/W	625

### ■ Ordering Information (Example)

PREFERED P/N	PACKING CODE	UNIT WEIGHT(g)	MINIMUM PACKAGE(pcs)	INNER BOX QUANTITY(pcs)	OUTER CARTON QUANTITY(pcs)	DELIVERY MODE
BZX584B2V4 THRU BZX584B36V	F2	Approximate 0.002	8000	80000	320000	7" reel



# BZX584B2V4 THRU BZX584B36V

## ■Electrical Characteristics (T<sub>a</sub>=25°C Unless otherwise specified)

TypeNumber	Device Marking	V <sub>z</sub> at I <sub>ZT</sub> (V)			Z <sub>zT</sub> (Ω)		Z <sub>zk</sub> (Ω)		I <sub>R</sub> (μA)@V <sub>R</sub>	
		min.	typ.	max.	I <sub>ZT</sub> (mA)	max.	I <sub>zk</sub> (mA)	max.	uA	V <sub>R</sub> (V)
BZX584B2V4	05	2.34	2.4	2.46	5	100	1	600	45	1
BZX584B2V7	15	2.56	2.7	2.84	5	100	1	600	20	1
BZX584B3V0	25	2.92	3.0	3.08	5	100	1	600	10	1
BZX584B3V3	35	3.21	3.3	3.39	5	95	1	600	15	1
BZX584B3V6	45	3.53	3.6	3.67	5	90	1	564	4.5	1
BZX584B3V9	+5	3.82	3.9	3.98	5	90	1	564	2.7	1
BZX584B4V3	65	4.21	4.3	4.39	5	90	1	564	2.7	1
BZX584B4V7	75	4.61	4.7	4.79	5	80	1	470	2.7	2
BZX584B5V1	85	5	5.1	5.2	5	60	1	451	1.8	2
BZX584B5V6	95	5.49	5.6	5.71	5	40	1	376	0.9	2
BZX584B6V2	A5	6.08	6.2	6.32	5	10	1	141	2.7	4
BZX584B6V8	B5	6.66	6.8	6.94	5	15	1	75	1.8	4
BZX584B7V5	C5	7.35	7.5	7.65	5	15	1	75	0.9	5
BZX584B8V2	D5	8.04	8.2	8.36	5	15	1	75	0.63	5
BZX584B9V1	E5	8.92	9.1	9.28	5	15	1	94	0.45	6
BZX584B10V	F5	9.8	10	10.2	5	20	1	141	0.18	7
BZX584B11V	G5	10.78	11	11.22	5	20	1	141	0.09	8
BZX584B12V	H5	11.76	12	12.24	5	25	1	141	0.09	8
BZX584B13V	J5	12.74	13	13.26	5	30	1	160	0.09	8
BZX584B15V	K5	14.7	15	15.3	5	30	1	188	0.045	10.5
BZX584B16V	L5	15.68	16	16.32	5	40	1	188	0.045	11.2
BZX584B18V	M5	17.64	18	18.36	5	45	1	212	0.045	12.6
BZX584B20V	N5	19.6	20	20.4	5	55	1	212	0.045	14
BZX584B22V	P5	21.56	22	22.44	5	55	1	235	0.045	15.4
BZX584B24V	R5	23.52	24	24.48	5	70	1	235	0.045	16.8
BZX584B27V	S5	26.46	27	27.54	2	80	0.5	282	0.045	18.9
BZX584B30V	T5	29.4	30	30.6	2	80	0.5	282	0.045	21
BZX584B33V	U5	32.34	33	33.66	2	80	0.5	306	0.045	23
BZX584B36V	V5	35.28	36	36.72	2	90	0.5	329	0.045	25.2



# BZX584B2V4 THRU BZX584B36V

## ■ Characteristics (Typical)

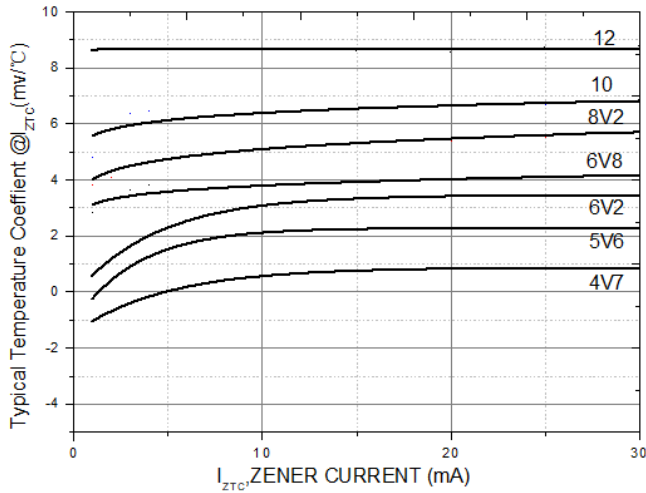
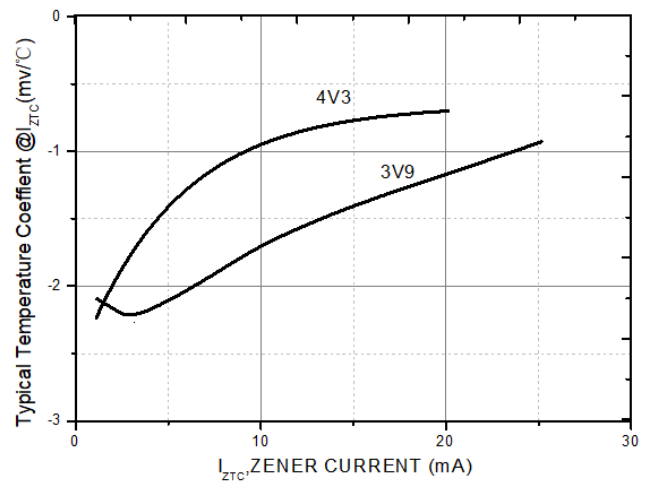
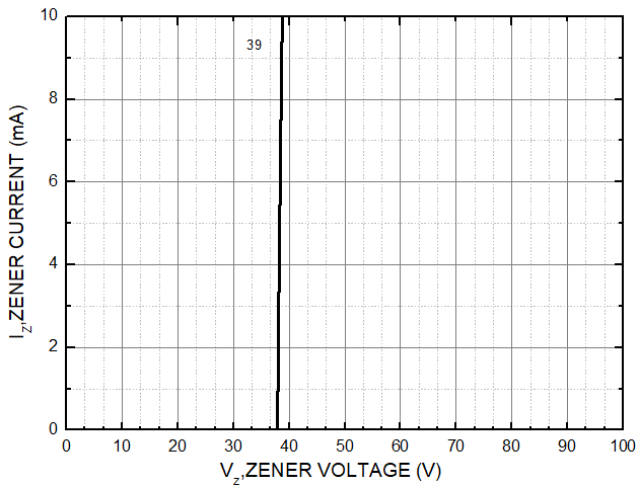
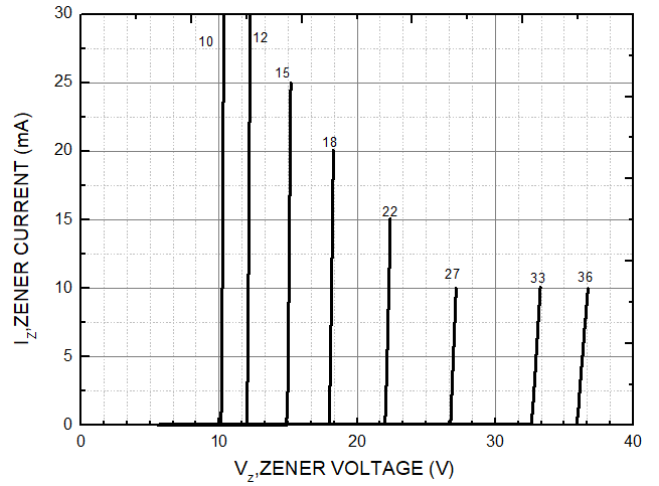
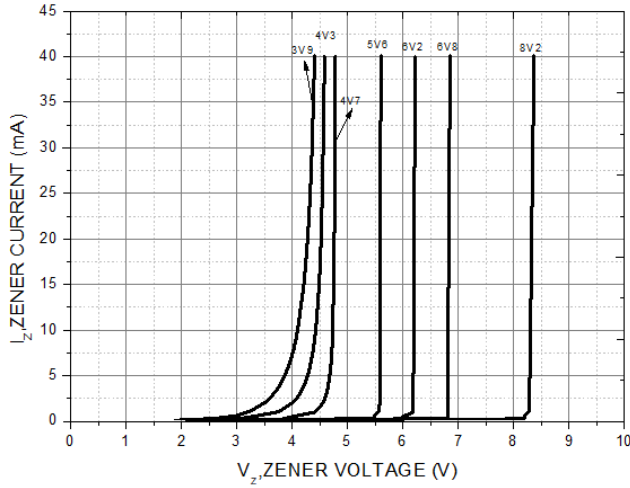



# BZX584B2V4 THRU BZX584B36V

## ■ Outline Dimensions

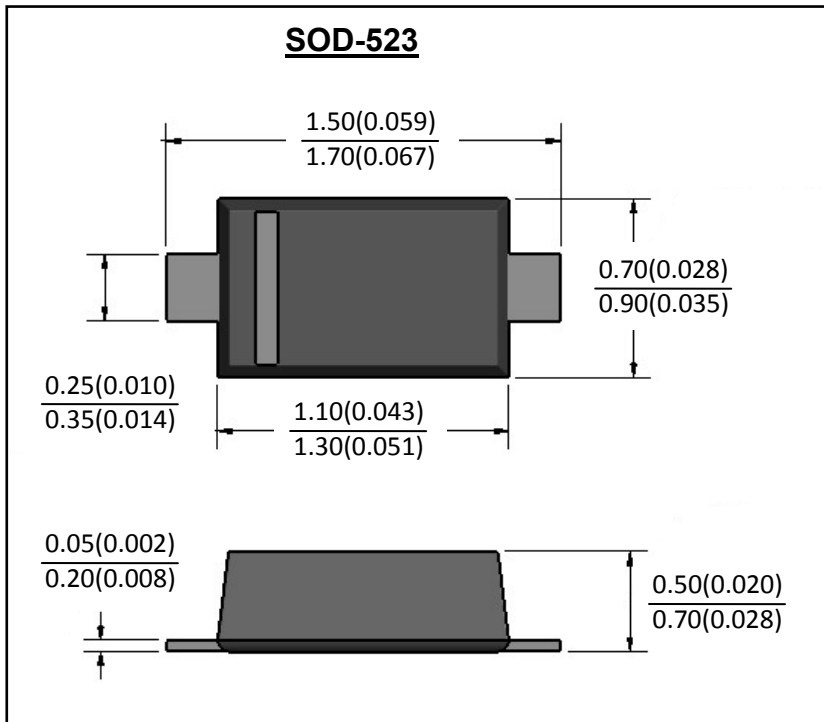

## ■ Soldering Footprint

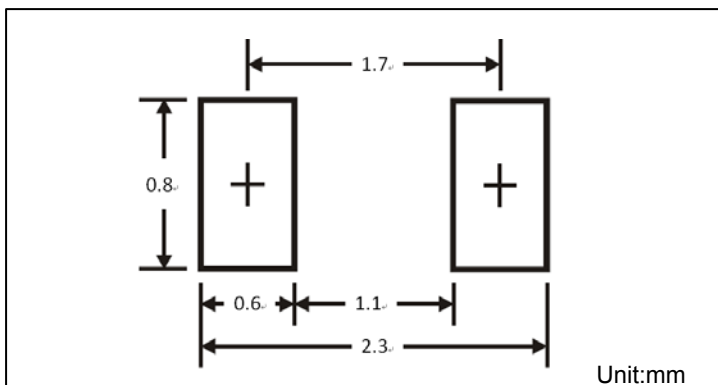



## BZX584B2V4 THRU BZX584B36V

---

### Disclaimer

The information presented in this document is for reference only. Yangzhou Yangjie Electronic Technology Co., Ltd. reserves the right to make changes without notice for the specification of the products displayed herein to improve reliability, function or design or otherwise.

The product listed herein is designed to be used with ordinary electronic equipment or devices, and not designed to be used with equipment or devices which require high level of reliability and the malfunction of which would directly endanger human life (such as medical instruments, transportation equipment, aerospace machinery, nuclear-reactor controllers, fuel controllers and other safety devices), Yangjie or anyone on its behalf, assumes no responsibility or liability for any damages resulting from such improper use of sale.

This publication supersedes & replaces all information previously supplied. For additional information, please visit our website [http:// www.21yangjie.com](http://www.21yangjie.com) , or consult your nearest Yangjie's sales office for further assistance.

## X-ON Electronics

Largest Supplier of Electrical and Electronic Components

*Click to view similar products for [Zener Diodes](#) category:*

*Click to view products by [Yangjie](#) manufacturer:*

Other Similar products are found below :

[RKZ13B2KG#P1](#) [DL5234B](#) [EDZTE6113B](#) [1N4682](#) [1N4693](#) [1N4732A](#) [1N4736A](#) [1N4750A](#) [1N4759ARL](#) [1N5241B](#) [1N5365B](#) [1N5369B](#)  
[1N747A](#) [1N964B](#) [1N966B](#) [1N968B](#) [1N972B](#) [JANS1N4974US](#) [JANTX1N5907](#) [1N4692](#) [1N4700](#) [1N4702](#) [1N4704](#) [1N4711](#) [1N4714](#)  
[1N4745ARL](#) [1N4752ARL](#) [1N4760ARL](#) [1N5221B](#) [1N5242BTR](#) [1N5350B](#) [1N5352B](#) [1N961BRR1](#) [1N964BRL](#) [RKZ5.1BKU#P6](#)  
[3SMAJ5946B-TP](#) [3SMAJ5950B-TP](#) [3SMBJ5925B-TP](#) [MMSZ5230BQ-13-F](#) [MMSZ5232BQ-13-F](#) [BZX84C7V5](#) [3SMAJ5945B-TP](#)  
[3SMAJ5947B-TP](#) [3SMBJ5941B-TP](#) [DL4732A-T3](#) [DZ2S240M0L](#) [SMAZ27-TP](#) [ZMM5224B-7](#) [RD16UM-T1-A](#) [RD39S-T1-A](#)