

Zener Diode

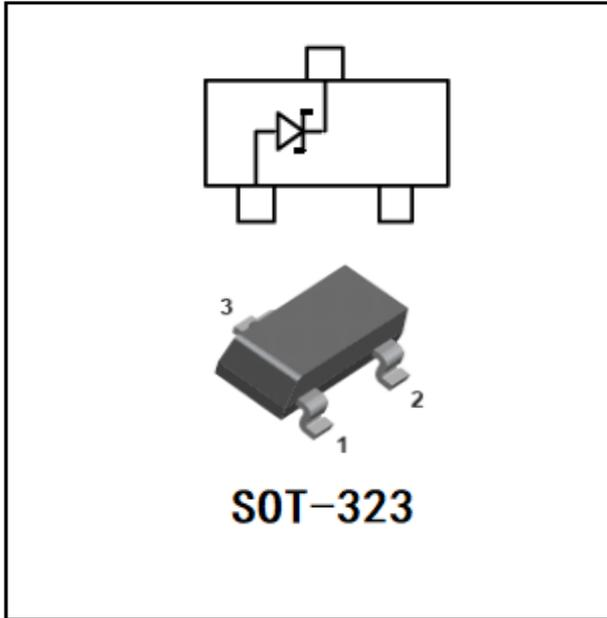

Features

- 200mW power dissipation rating.
- Epoxy meets UL-94 V-0 flammability rating
- Zener Voltage from 2.4V to 39V.
- Moisture Sensitivity Level 1
- High Conductance
- Surface mount package ideally Suited for Automatic Insertion

Mechanical Data

- **Package:** SOT-323
- **Terminals:** Tin plated leads, solderable per J-STD-002 and JESD22-B102

■ Limiting Values (Absolute Maximum Rating, Ta=25°C Unless otherwise specified)

Characteristic	Symbol	Value	Units
Maximum Forward Voltage@I _F =10mA	V _F	0.9	V
Power Dissipation	PD	200	mW
Peak Forward Surge Current*	I _{FSM}	2.0	A
Thermal Resistance	R _{thJA}	625	°C /W
Operation Temperature	T _J	-55~+150	°C
Storage Temperature Range	TSTG	-55~+150	°C

*Measured on 8.3ms, single half sine-wave

■ Ordering Information (Example)

PREFERED P/N	PACKING CODE	UNIT WEIGHT(g)	MINIMUM PACKAGE(pcs)	INNER BOX QUANTITY(pcs)	OUTER CARTON QUANTITY(pcs)	DELIVERY MODE
BZX84C2V4W THRU BZX84C39W	F2	Approximate 0.005	3000	30000	120000	7" reel



BZX84C2V4W THRU BZX84C39W

■Electrical Characteristics (T_a=25°C Unless otherwise specified)

Type Number	Marking Code	Nominal Zener Voltage			Maximum Zener Impedance				Max Reverse Leakage Current	
		V _Z (V)@ I _{ZT}			Z _{ZT} @I _{ZT}		Z _{Zk} @I _{Zk}		I _R (μA)@ V _R	
		Min.	Typ.	Max.	Z _{ZT} (Ω)	I _{ZT} (mA)	Z _{Zk} (Ω)	I _{Zk} (mA)	Max	V _R (V)
BZX84C2V4W	KRB	2.28	2.4	2.52	100	5	600	1	50	1
BZX84C2V7W	KRC	2.5	2.7	2.9	100	5	600	1	20	1
BZX84C3V0W	KRD	2.8	3.0	3.2	95	5	600	1	10	1
BZX84C3V3W	KRE	3.1	3.3	3.5	95	5	600	1	5	1
BZX84C3V6W	KRF	3.4	3.6	3.8	90	5	600	1	5	1
BZX84C3V9W	KRG	3.7	3.9	4.1	90	5	600	1	3	1
BZX84C4V3W	KRH	4.0	4.3	4.6	90	5	600	1	3	1
BZX84C4V7W	KR1	4.4	4.7	5.0	80	5	500	1	3	2
BZX84C5V1W	KR2	4.8	5.1	5.4	60	5	480	1	2	2
BZX84C5V6W	KR3	5.2	5.6	6.0	40	5	400	1	1	2
BZX84C6V2W	KR4	5.8	6.2	6.6	10	5	150	1	3	4
BZX84C6V8W	KR5	6.4	6.8	7.2	15	5	80	1	2	4
BZX84C7V5W	KR6	7.0	7.5	7.9	15	5	80	1	1	5
BZX84C8V2W	KR7	7.7	8.2	8.7	15	5	80	1	0.7	5
BZX84C9V1W	KR8	8.5	9.1	9.6	15	5	100	1	0.5	6
BZX84C10W	KR9	9.4	10	10.6	20	5	150	1	0.2	7
BZX84C11W	KP1	10.4	11	11.6	20	5	150	1	0.1	8
BZX84C12W	KP2	11.4	12	12.7	25	5	150	1	0.1	8
BZX84C13W	KP3	12.4	13	14.1	30	5	170	1	0.1	8
BZX84C15W	KP4	13.8	15	15.6	30	5	200	1	0.1	10.5
BZX84C16W	KP5	15.3	16	17.1	40	5	200	1	0.1	11.2
BZX84C18W	KP6	16.8	18	19.1	45	5	225	1	0.1	12.6
BZX84C20W	KP7	18.8	20	21.2	55	5	225	1	0.1	14
BZX84C22W	KP8	20.8	22	23.3	55	5	250	1	0.1	15.4
BZX84C24W	KP9	22.8	24	25.6	70	5	250	1	0.1	16.8
BZX84C27W	KPA	25.1	27	28.9	80	2	300	1	0.1	18.9
BZX84C30W	KPB	28	30	32	80	2	300	1	0.1	21.0
BZX84C33W	KPC	31	33	35	80	2	325	1	0.1	23.1
BZX84C36W	KPD	34	36	38	90	2	350	1	0.1	25.2
BZX84C39W	KPE	37	39	41	130	2	350	1	0.1	27.3



BZX84C2V4W THRU BZX84C39W

■ Characteristics(Typical)

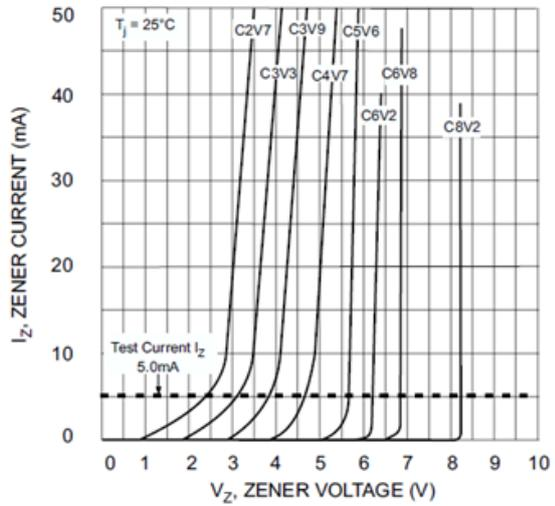
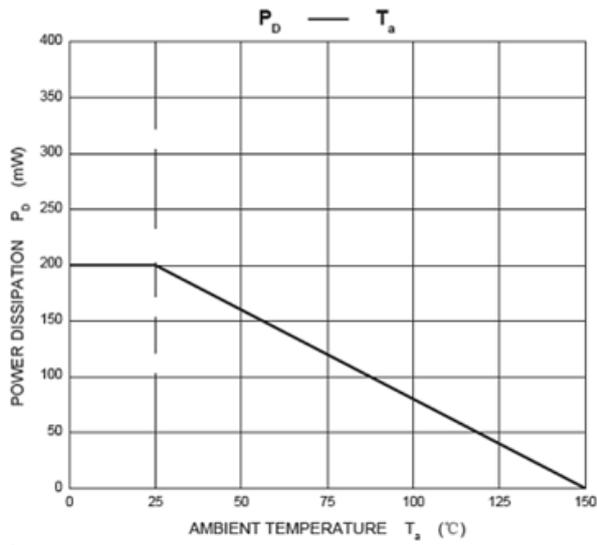

Fig. 3 Zener Breakdown Characteristics

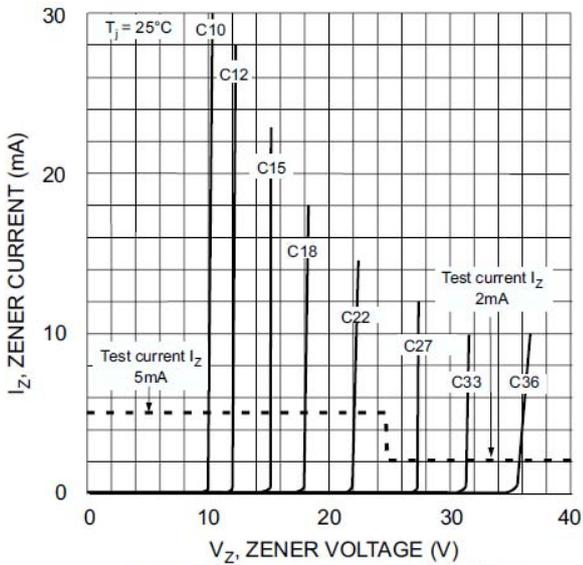

Fig. 4 Zener Breakdown Characteristics

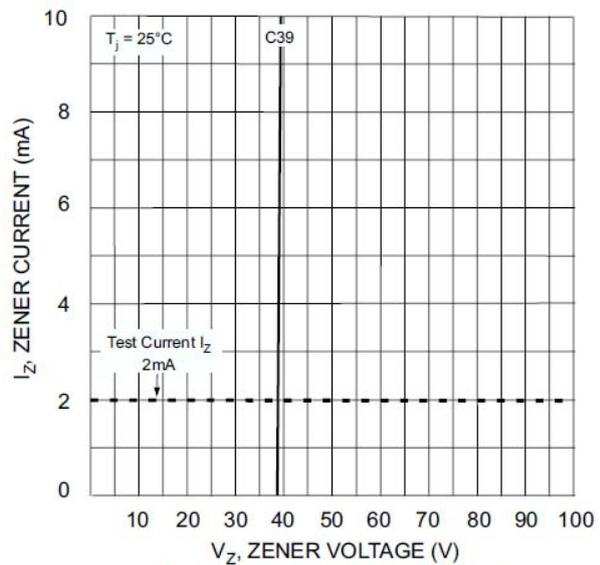

Fig. 5 Zener Breakdown Characteristics

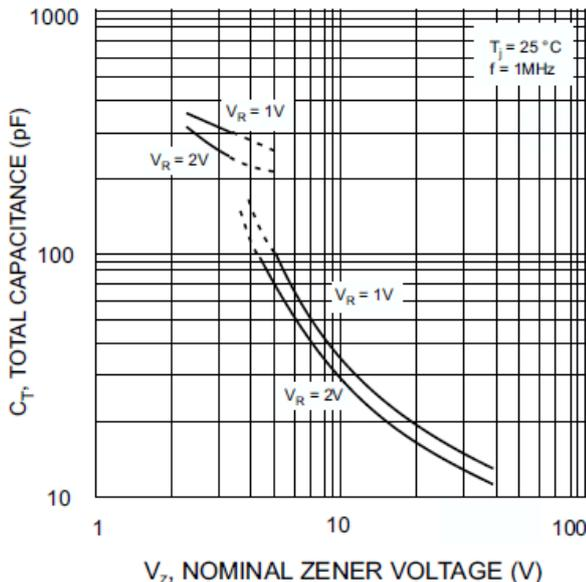
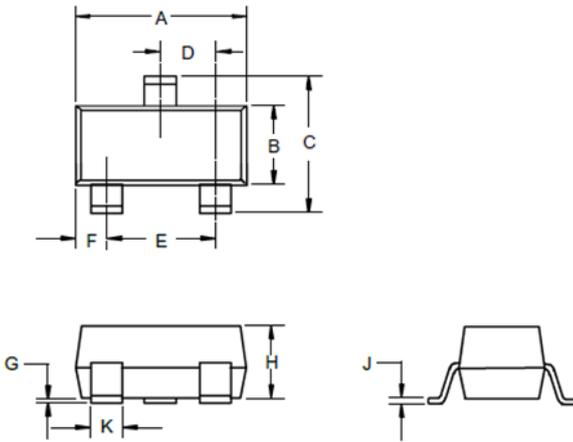

Fig. 1 Total Capacitance vs Nominal Zener Voltage



BZX84C2V4W THRU BZX84C39W

■ SOT-323 Package Outline Dimensions



DIMENSIONS					
DIM	INCHES		MM		NOTE
	MIN	MAX	MIN	MAX	
A	.071	.087	1.80	2.20	
B	.045	.053	1.15	1.35	
C	.083	.096	2.10	2.45	
D	.026 Nominal		0.65Nominal		
E	.047	.055	1.20	1.40	
F	.012	.016	.30	.40	
G	.000	.004	.000	.100	
H	.035	.039	.90	1.00	
J	.004	.010	.100	.250	
K	.006	.016	.15	.40	

■ SOT-323 Suggested Pad Layout

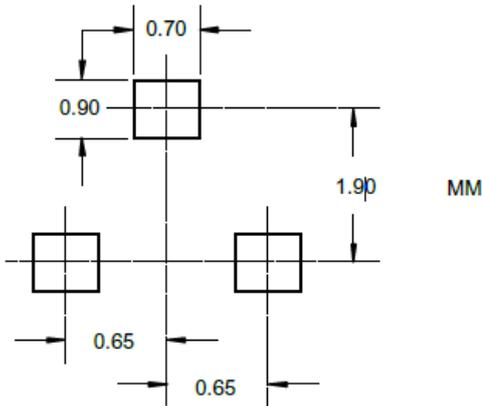



BZX84C2V4W THRU BZX84C39W

Disclaimer

The information presented in this document is for reference only. Yangzhou Yangjie Electronic Technology Co., Ltd. reserves the right to make changes without notice for the specification of the products displayed herein to improve reliability, function or design or otherwise.

The product listed herein is designed to be used with ordinary electronic equipment or devices, and not designed to be used with equipment or devices which require high level of reliability and the malfunction of which would directly endanger human life (such as medical instruments, transportation equipment, aerospace machinery, nuclear-reactor controllers, fuel controllers and other safety devices), Yangjie or anyone on its behalf, assumes no responsibility or liability for any damages resulting from such improper use of sale.

This publication supersedes & replaces all information previously supplied. For additional information, please visit our website [http:// www.21yangjie.com](http://www.21yangjie.com) , or consult your nearest Yangjie's sales office for further assistance.

X-ON Electronics

Largest Supplier of Electrical and Electronic Components

Click to view similar products for [Zener Diodes](#) category:

Click to view products by [Yangjie](#) manufacturer:

Other Similar products are found below :

[RKZ13B2KG#P1](#) [DL5234B](#) [EDZTE6113B](#) [1N4682](#) [1N4693](#) [1N4732A](#) [1N4736A](#) [1N4750A](#) [1N4759ARL](#) [1N5241B](#) [1N5365B](#) [1N5369B](#)
[1N747A](#) [1N964B](#) [1N966B](#) [1N968B](#) [1N972B](#) [JANS1N4974US](#) [JANTX1N5907](#) [1N4692](#) [1N4700](#) [1N4702](#) [1N4704](#) [1N4711](#) [1N4714](#)
[1N4745ARL](#) [1N4752ARL](#) [1N4760ARL](#) [1N5221B](#) [1N5242BTR](#) [1N5350B](#) [1N5352B](#) [1N961BRR1](#) [1N964BRL](#) [RKZ5.1BKU#P6](#)
[3SMAJ5946B-TP](#) [3SMAJ5950B-TP](#) [3SMBJ5925B-TP](#) [MMSZ5230BQ-13-F](#) [MMSZ5232BQ-13-F](#) [BZX84C7V5](#) [3SMAJ5945B-TP](#)
[3SMAJ5947B-TP](#) [3SMBJ5941B-TP](#) [DL4732A-T3](#) [DZ2S240M0L](#) [SMAZ27-TP](#) [ZMM5224B-7](#) [RD16UM-T1-A](#) [RD39S-T1-A](#)