

Surface Mount Super Fast Recovery Rectifier



Features

- Low profile package
- Ideal for automated placement
- Glass passivated chip junction
- High forward surge capability
- Super Fast reverse recovery time
- Meets MSL level 1, per J-STD-020, LF maximum peak of 260 °C

Typical Applications

For use in high frequency rectification of power supplies, inverters, converters, and freewheeling diodes for consumer and telecommunication.

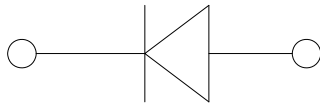

Mechanical Data

- **Package:** DO-214AC (SMA)
Molding compound meets UL 94 V-0 flammability rating, RoHS-compliant, halogen-free
- **Terminals:** Tin plated leads, solderable per J-STD-002 and JESD22-B102
- **Polarity:** Cathode line denotes the cathode end

■ Maximum Ratings ($T_a=25^\circ\text{C}$ Unless otherwise specified)

PARAMETER	SYMBOL	UNIT	ES1A	ES1B	ES1C	ES1D	ES1F	ES1G	ES1H	ES1J	ES1K
Device marking code			ES1A	ES1B	ES1C	ES1D	ES1F	ES1G	ES1H	ES1J	ES1K
Repetitive peak reverse voltage	VRRM	V	50	100	150	200	300	400	500	600	800
Average rectified output current @ 60Hz sine wave, Resistance load, TL (FIG.1)	I_O	A	1.0								
Surge(non-repetitive)forward current @ 60Hz Half-sine wave,1 cycle, $T_a=25^\circ\text{C}$	IFSM	A	30								
Storage temperature	T_{stg}	$^\circ\text{C}$	-55~+150								
Junction temperature	T_j	$^\circ\text{C}$	-55~+150								

■ Electrical Characteristics ($T_a=25^\circ\text{C}$ Unless otherwise specified)

PARAMETER	SYMBOL	UNIT	TEST CONDITIONS	ES1A	ES1B	ES1C	ES1D	ES1F	ES1G	ES1H	ES1J	ES1K
Maximum instantaneous forward voltage drop per diode	V_F	V	$I_{FM}=1.0A$	0.95				1.3		1.7		1.85
Maximum reverse recovery time	T_{RR}	ns	$I_F=0.5A, I_R=1.0A, I_r=0.25A$	35								
Maximum DC reverse current at rated DC blocking voltage per diode @ VRM=VRRM	IRRM	μA	$T_a=25^\circ\text{C}$	5								
			$T_a=125^\circ\text{C}$	100								



ES1A THRU ES1K

■ Thermal Characteristics ($T_a=25^\circ\text{C}$ Unless otherwise specified)

PARAMETER	SYMBOL	UNIT	ES1A	ES1B	ES1C	ES1D	ES1F	ES1G	ES1H	ES1J	ES1K
Thermal Resistance	R θ J-A	$^\circ\text{C}/\text{W}$	65 ¹⁾								
	R θ J-L		20 ¹⁾								
	R θ J-C		25 ¹⁾								

Note

(1) Thermal resistance from junction to ambient and from junction to lead mounted on P.C.B. with 0.2" x 0.2" (5.0 mm x 5.0 mm) copper pad areas

■ Characteristics (Typical)

FIG.1: Io-TL Curve

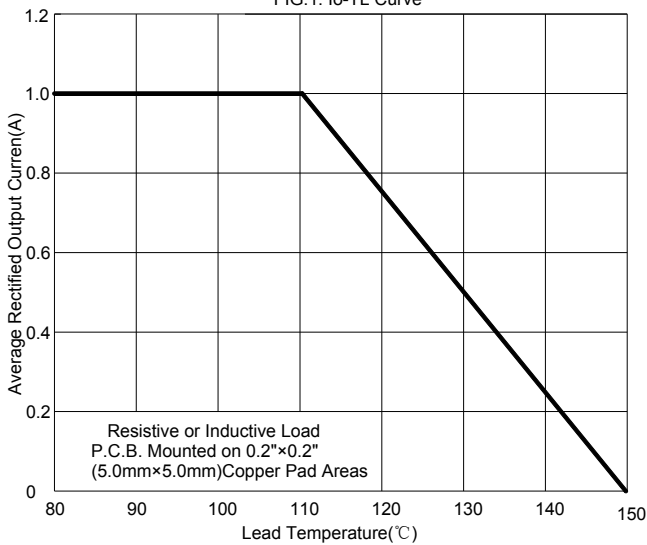

FIG2: Surge Forward Current Capability

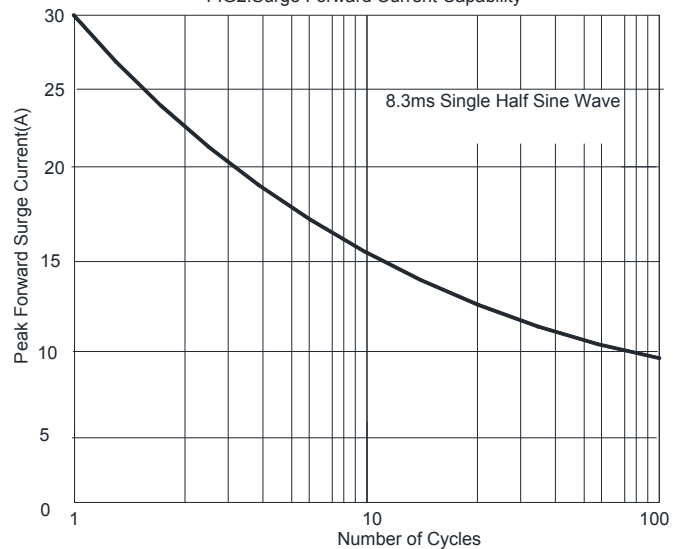

FIG3: Forward Voltage

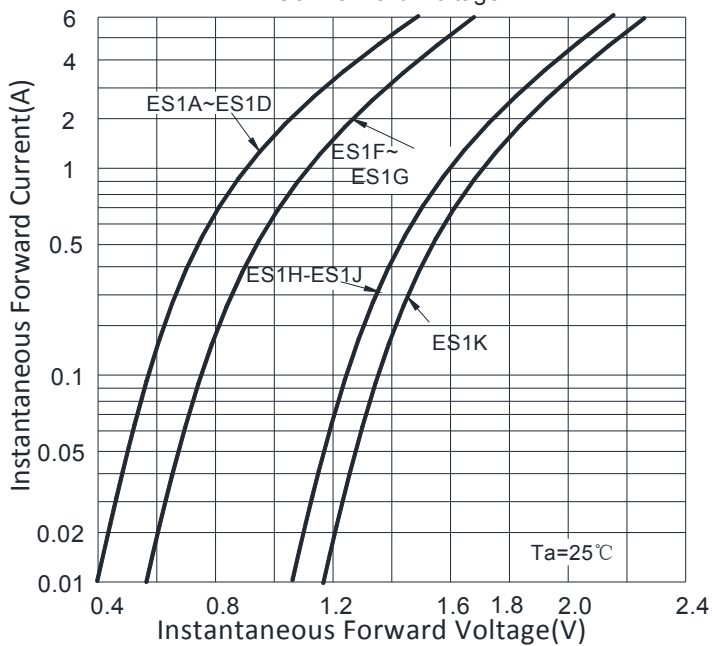
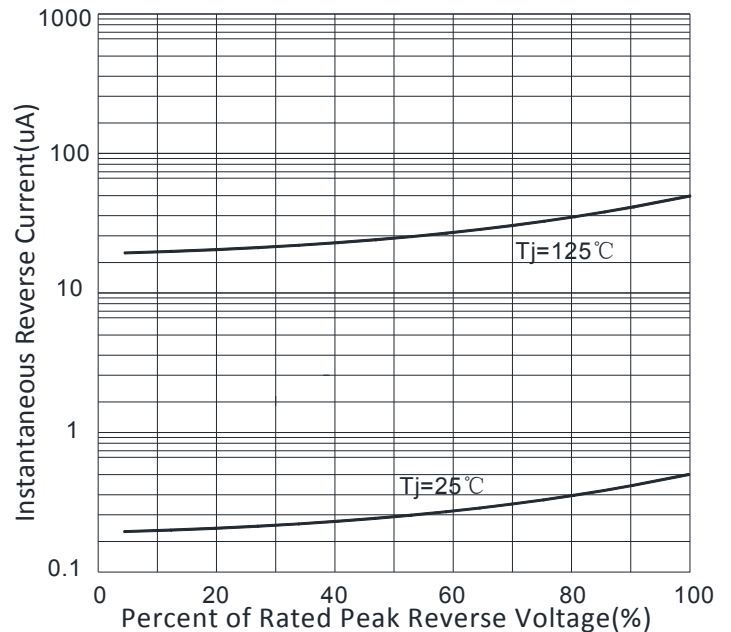

FIG4: Typical Reverse Characteristics





ES1A THRU ES1K

FIG.5: Diagram of circuit and Testing wave form of reverse recovery time

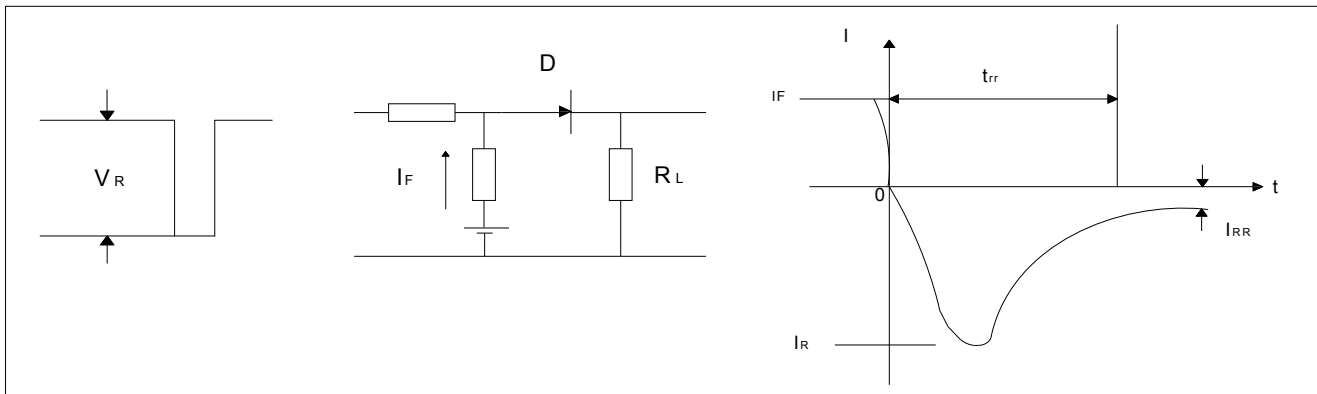

Ordering Information (Example)

PREFERRED P/N	PACKAGE CODE	UNIT WEIGHT(g)	MINIMUM PACKAGE(pcs)	INNER BOX QUANTITY(pcs)	OUTER CARTON QUANTITY(pcs)	DELIVERY MODE
ES1A- ES1K	F1	Approximate 0.059	5000	10000	80000	13" reel
ES1A- ES1K	F2	Approximate 0.059	7500	15000	120000	13" reel
ES1A- ES1K	F3	Approximate 0.059	7500	15000	60000	13" reel
ES1A- ES1K	F4	Approximate 0.059	1800	7200	57600	7" reel
ES1A- ES1K	F5	Approximate 0.059	2000	8000	64000	7" reel
ES1A- ES1K	F6	Approximate 0.059	5000	10000	100000	13" reel

Outline Dimensions

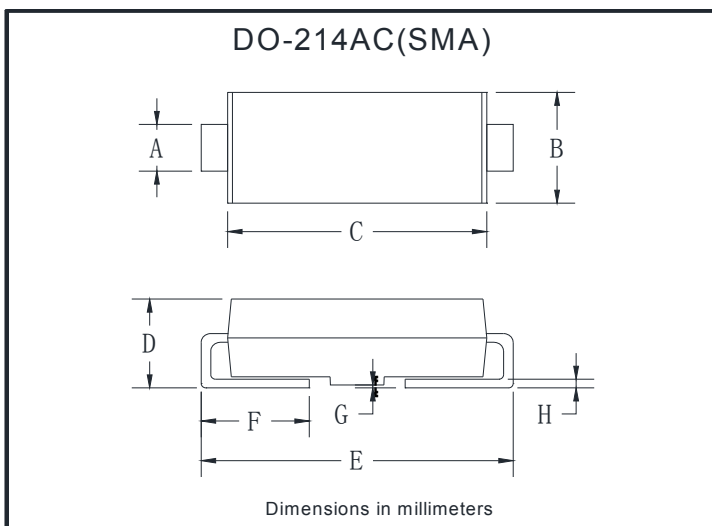

DO-214AC(SMA)		
Dim	Min	Max
A	1.25	1.58
B	2.40	2.83
C	4.25	4.75
D	1.90	2.30
E	4.93	5.28
F	0.76	1.41
G	0.08	0.20
H	0.15	0.31



ES1A THRU ES1K

■ Suggested Pad Layout

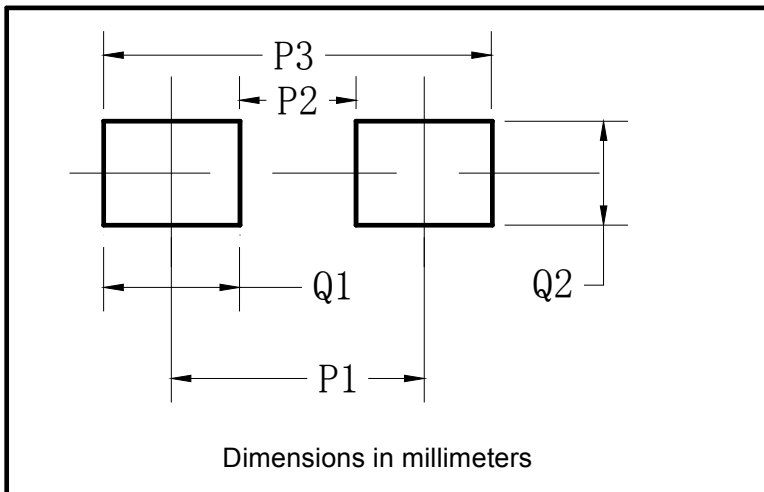

DO-214AC(SMA)	
Dim	Millimeters
P1	4.00
P2	1.50
P3	6.50
Q1	2.50
Q2	1.70



ES1A THRU ES1K

Disclaimer

The information presented in this document is for reference only. Yangzhou Yangjie Electronic Technology Co., Ltd. reserves the right to make changes without notice for the specification of the products displayed herein to improve reliability, function or design or otherwise.

The product listed herein is designed to be used with ordinary electronic equipment or devices, and not designed to be used with equipment or devices which require high level of reliability and the malfunction of which would directly endanger human life (such as medical instruments, transportation equipment, aerospace machinery, nuclear-reactor controllers, fuel controllers and other safety devices), Yangjie or anyone on its behalf, assumes no responsibility or liability for any damages resulting from such improper use of sale.

This publication supersedes & replaces all information previously supplied. For additional information, please visit our website [http:// www.21yangjie.com](http://www.21yangjie.com) , or consult your nearest Yangjie's sales office for further assistance.

X-ON Electronics

Largest Supplier of Electrical and Electronic Components

Click to view similar products for [Rectifiers](#) category:

Click to view products by [Yangjie](#) manufacturer:

Other Similar products are found below :

[70HFR40](#) [FR105 R0](#) [RL252-TP](#) [1N5397](#) [1N4005-TR](#) [1N4007-BP](#) [UFS120Je3/TR13](#) [20ETS12S](#) [RRE02VS6SGTR](#) [MS306](#) [A1N5404G-G](#)
[CRF02\(T5L,TEMQ\)](#) [ACGRB207-HF](#) [CLH07\(TE16L,Q\)](#) [CLH03\(TE16L,Q\)](#) [1N5395-TP](#) [UES1302](#) [ACGRC307-HF](#) [ACEFC304-HF](#) [DZ-](#)
[1380](#) [85HFR60](#) [40HFR60](#) [70HF120](#) [85HFR80](#) [SCF7500](#) [SM100](#) [ACGRA4001-HF](#) [SKN70/08](#) [NTE5819](#) [NTE5827](#) [NTE5828](#) [NTE5911](#)
[NTE5915](#) [NTE6104](#) [NTE6163](#) [NTE6164](#) [NTE6165](#) [NTE6364](#) [TSD3G](#) [SET130312](#) [NRVUS110VT3G](#) [UES1106](#) [UES1306](#)
[NRVUS240VT3G](#) [D5FE60-5063](#) [R4000GPS-TP](#) [D4015L56TP](#) [UES1306HR2](#) [FX20K120](#) [D20XB60-7101](#)