

Surface Mount Super Fast Recovery Rectifier

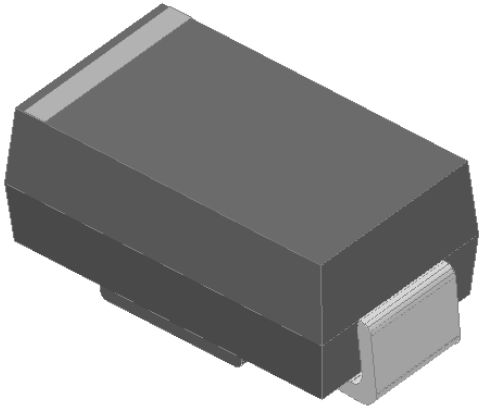

Features

- Low profile package
- Ideal for automated placement
- Glass passivated chip junction
- High forward surge capability
- Super Fast reverse recovery time
- Meets MSL level 1, per J-STD-020, LF maximum peak of 260 °C
- Part no. with suffix "Q" means AEC-Q101 qualified

Typical Applications

For use in high frequency rectification of power supplies, inverters, converters, and freewheeling diodes for consumer, automotive and telecommunication.

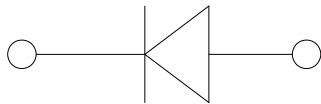

Mechanical Data

- **Package:** DO-214AC (SMA)
Molding compound meets UL 94 V-0 flammability rating, RoHS-compliant, halogen-free
- **Terminals:** Tin plated leads, solderable per J-STD-002 and JESD22-B102
- **Polarity:** Cathode line denotes the cathode end

■Maximum Ratings (Ta=25°C Unless otherwise specified)

PARAMETER	SYMBOL	UNIT	ES2AAQ	ES2BAQ	ES2CAQ	ES2DAQ	ES2FAQ	ES2GAQ	ES2HAQ	ES2JAQ
Device marking code			ES2AA	ES2BA	ES2CA	ES2DA	ES2FA	ES2GA	ES2HA	ES2JA
Repetitive peak reverse voltage	V _{RRM}	V	50	100	150	200	300	400	500	600
Maximum RMS Voltage	V _{RMS}	V	35	70	105	140	210	280	350	420
Maximum DC blocking Voltage	V _{DC}	V	50	100	150	200	300	400	500	600
Average rectified output current @60Hz sine wave, Resistance load, T _L (Fig.1)	I _O	A	2.0							
Surge(non-repetitive)forward current @60Hz Half-sine wave,1 cycle, Ta=25°C	I _{FSM}	A	50							
Storage temperature	T _{stg}	°C	-55~+150							
Junction temperature	T _J	°C	-55 ~ +150							

■Electrical Characteristics (Ta=25°C Unless otherwise specified)

PARAMETER	SYMBOL	UNIT	TEST CONDITIONS	ES2AAQ	ES2BAQ	ES2CAQ	ES2DAQ	ES2FAQ	ES2GAQ	ES2HAQ	ES2JAQ
Maximum instantaneous forward voltage drop per diode	V _F	V	I _{FM} =2.0A	0.95				1.3		1.7	
Maximum reverse recovery time	T _{RR}	ns	I _F =0.5A, I _R =1.0A, I _{rr} =0.25A	35							
Typical junction capacitance	C _J	pF	V _R =4V, f=1MHz	30				25		20	
Maximum DC reverse current at rated DC blocking voltage per diode@ V _{RM} =V _{RRM}	I _{RRM}	μA	Ta=25°C	5							
			Ta=125°C	100							



ES2AAQ THRU ES2JAQ

■ Thermal Characteristics (Ta=25°C Unless otherwise specified)

PARAMETER	SYMBOL	UNIT	ES2AAQ	ES2BAQ	ES2CAQ	ES2DAQ	ES2FAQ	ES2GAQ	ES2HAQ	ES2JAQ
Thermal Resistance	R _{θJ-A}	°C/W	85 ¹⁾							
	R _{θJ-L}	°C/W	20 ¹⁾							

Note

(1) Thermal resistance from junction to ambient and from junction to lead mounted on P.C.B. with 0.2" x 0.2" (5.0 mm x 5.0 mm) copper pad areas

■ Characteristics (Typical)

Fig.1: I_O-T_L Curve

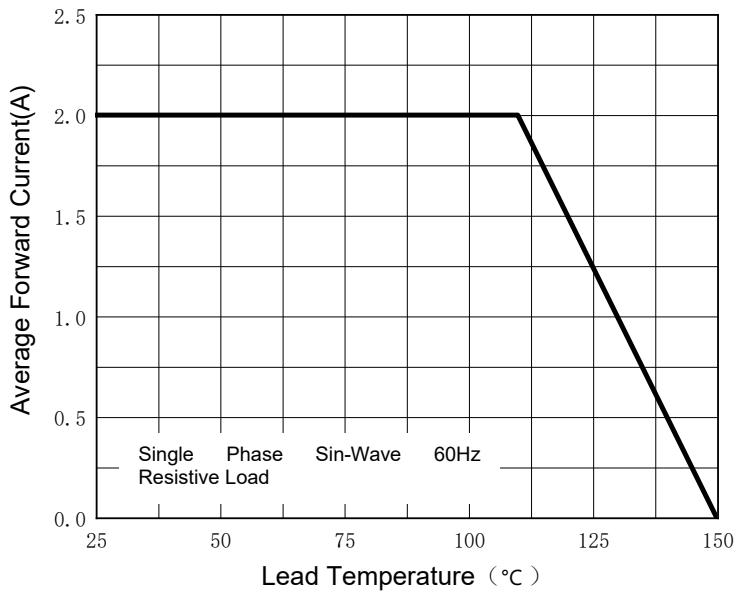

Fig.2: Surge Forward Current Capability

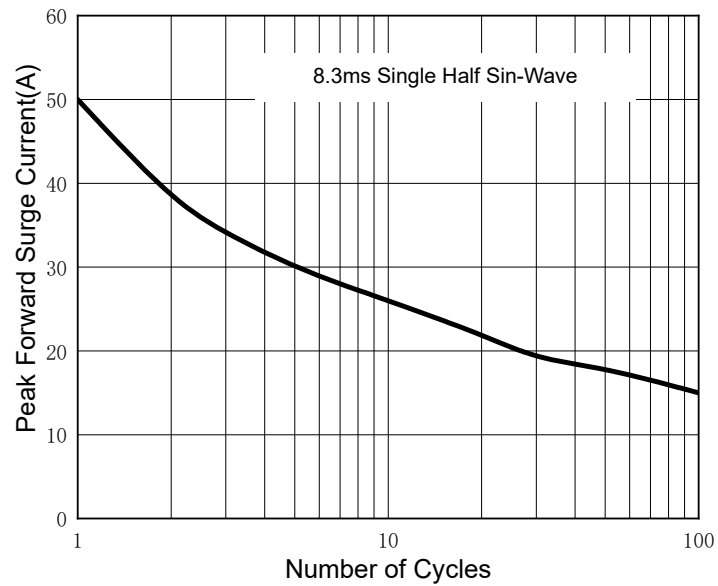

Fig.3: Typical Forward Characteristics

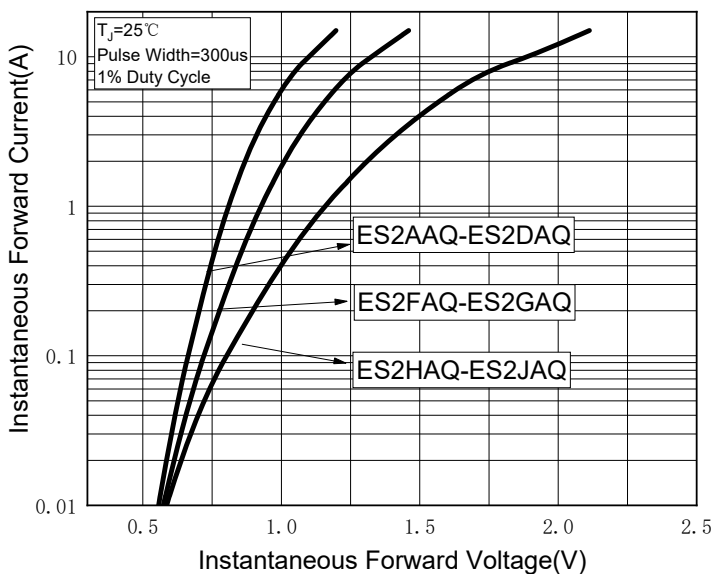
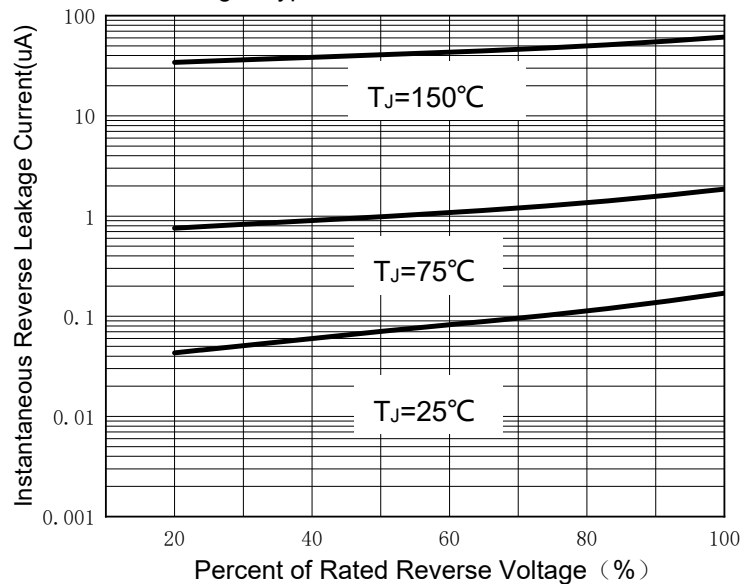

Fig.4: Typical Reverse Characteristics





ES2AAQ THRU ES2JAQ

FIG.5: Diagram of circuit and Testing wave form of reverse recovery time

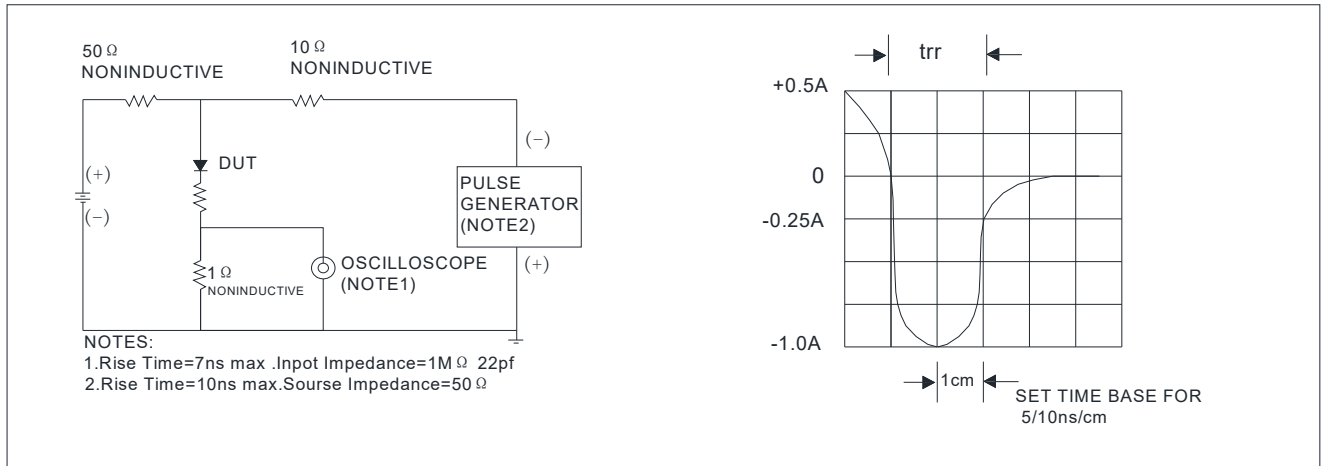

Ordering Information (Example)

PREFERRED P/N	PACKAGE CODE	UNIT WEIGHT(g)	MINIMUM PACKAGE(pcs)	INNER BOX QUANTITY(pcs)	OUTER CARTON QUANTITY(pcs)	DELIVERY MODE
ES2AAQ- ES2JAQ	F2	Approximate 0.067	7500	/	120000	13" reel

Outline Dimensions

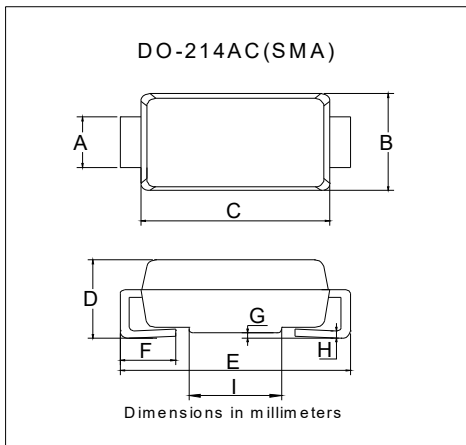

DO-214AC(SMA)		
Dim	Min	Max
A	1.25	1.58
B	2.40	2.83
C	4.00	4.75
D	1.90	2.30
E	4.93	5.28
F	0.76	1.41
G	0.05	0.20
H	0.15	0.31
I	1.7	2.1

Suggested Pad Layout

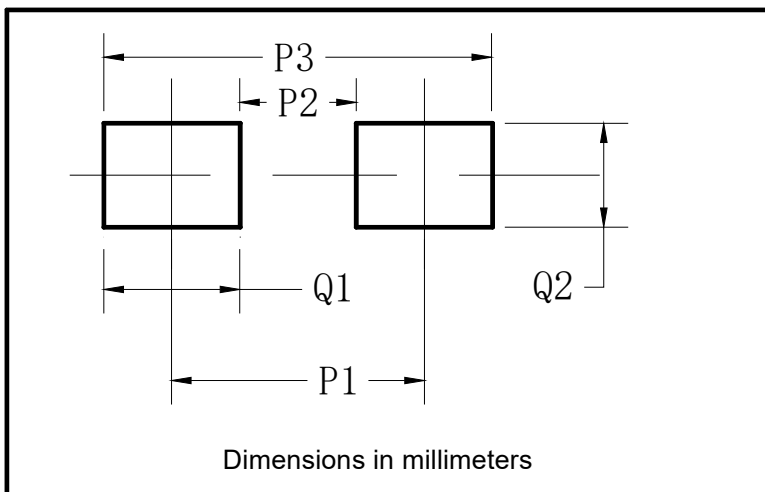

DO-214AC(SMA)	
Dim	Millimeters
P1	4.00
P2	1.50
P3	6.50
Q1	2.50
Q2	1.70



Disclaimer

The information presented in this document is for reference only. Yangzhou Yangjie Electronic Technology Co., Ltd. reserves the right to make changes without notice for the specification of the products displayed herein to improve reliability, function or design or otherwise.

The product listed herein is designed to be used with automotive electronics, are not designed for use in medical, lifesaving, lifesustaining, or military, Yangjie or anyone on its behalf, assumes no responsibility or liability for any damages resulting from such improper use of sale.

This publication supersedes & replaces all information previously supplied. For additional information, please visit our website [http:// www.21yangjie.com](http://www.21yangjie.com) , or consult your nearest Yangjie's sales office for further assistance.

X-ON Electronics

Largest Supplier of Electrical and Electronic Components

Click to view similar products for [Rectifiers](#) category:

Click to view products by [Yangjie](#) manufacturer:

Other Similar products are found below :

[70HFR40](#) [FR105 R0](#) [RL252-TP](#) [1N5397](#) [1N4005-TR](#) [1N4007-BP](#) [UFS120Je3/TR13](#) [20ETS12S](#) [RRE02VS6SGTR](#) [MS306](#) [A1N5404G-G](#)
[CRF02\(T5L,TEMQ\)](#) [ACGRB207-HF](#) [CLH07\(TE16L,Q\)](#) [CLH03\(TE16L,Q\)](#) [1N5395-TP](#) [UES1302](#) [ACGRC307-HF](#) [ACEFC304-HF](#) [DZ-](#)
[1380](#) [85HFR60](#) [40HFR60](#) [70HF120](#) [85HFR80](#) [SCF7500](#) [SM100](#) [ACGRA4001-HF](#) [SKN70/08](#) [NTE5819](#) [NTE5827](#) [NTE5828](#) [NTE5911](#)
[NTE5915](#) [NTE6104](#) [NTE6163](#) [NTE6164](#) [NTE6165](#) [NTE6364](#) [TSD3G](#) [SET130312](#) [NRVUS110VT3G](#) [UES1106](#) [UES1306](#)
[NRVUS240VT3G](#) [D5FE60-5063](#) [R4000GPS-TP](#) [D4015L56TP](#) [UES1306HR2](#) [FX20K120](#) [D20XB60-7101](#)