

Surface Mount General Purpose Rectifier

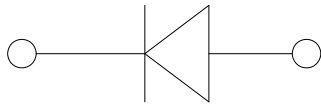
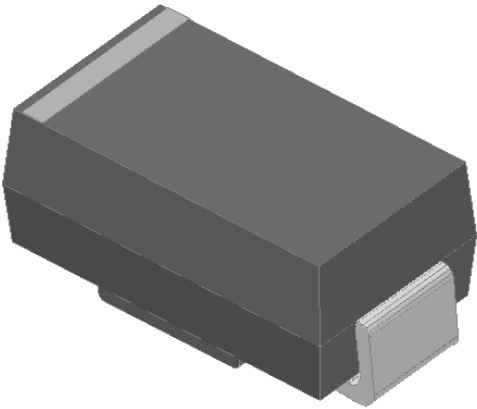

Features

- Low profile package
- Ideal for automated placement
- Glass passivated chip junction
- High forward surge capability
- Meets MSL level 1, per J-STD-020, LF maximum peak of 260 °C
- Part no. with suffix "Q" means AEC-Q101 qualified

Typical Applications

For use in general purpose rectification of power supplies, inverters, converters, and freewheeling diodes for consumer, automotive and telecommunication.

Mechanical Data

- **Package:** DO-214AC (SMA)
Molding compound meets UL 94 V-0 flammability rating, RoHS-compliant, halogen-free
- **Terminals:** Tin plated leads, solderable per J-STD-002 and JESD22-B102
- **Polarity:** Cathode line denotes the cathode end

■ Maximum Ratings ($T_a=25^\circ\text{C}$ Unless otherwise specified)

PARAMETER	SYMBOL	UNIT	GS2AAQ	GS2BAQ	GS2DAQ	GS2GAQ	GS2JAQ	GS2KAQ	GS2MAQ
Device marking code			GS2AA	GS2BA	GS2DA	GS2GA	GS2JA	GS2KA	GS2MA
Repetitive peak reverse voltage	V_{RRM}	V	50	100	200	400	600	800	1000
Maximum RMS voltage	V_{RMS}	V	35	70	140	280	420	560	700
Average rectified output current @60Hz sine wave, Resistance load, TL (Fig.1)	I_O	A	2						
Surge(non-repetitive)forward current @60Hz Half-sine wave,1 cycle, $T_a=25^\circ\text{C}$	I_{FSM}	A	50						
Storage temperature	T_{stg}	$^\circ\text{C}$	-55~+150						
Junction temperature	T_J	$^\circ\text{C}$	-55 ~ +150						

■ Electrical Characteristics ($T_a=25^\circ\text{C}$ Unless otherwise specified)

PARAMETER	SYMBOL	UNIT	TEST CONDITIONS	GS2AAQ	GS2BAQ	GS2DAQ	GS2GAQ	GS2JAQ	GS2KAQ	GS2MAQ
Maximum instantaneous forward voltage drop per diode	V_F	V	$I_{FM}=2.0A$	1.15						
Typical junction capacitance	C_J	pF	$V_R=4V, 1\text{ MHz}$	18						
Maximum DC reverse current at rated DC blocking voltage per diode @ $V_{RM}=V_{RRM}$	I_{RRM}	μA	$T_a=25^\circ\text{C}$	5						
			$T_a=125^\circ\text{C}$	100						



GS2AAQ THRU GS2MAQ

■ Thermal Characteristics ($T_a=25^\circ\text{C}$ Unless otherwise specified)

PARAMETER	SYMBOL	UNIT	GS2AAQ	GS2BAQ	GS2DAQ	GS2GAQ	GS2JAQ	GS2KAQ	GS2MAQ
Thermal Resistance	$R_{\theta J-A}$	$^\circ\text{C/W}$	55 ¹⁾						
	$R_{\theta J-L}$	$^\circ\text{C/W}$	20 ¹⁾						

Note

(1) Thermal resistance from junction to ambient and from junction to lead mounted on P.C.B. with 0.2" x 0.2" (5.0 mm x 5.0 mm) copper pad areas

■ Characteristics (Typical)

Fig1: I_o - T_L Curve

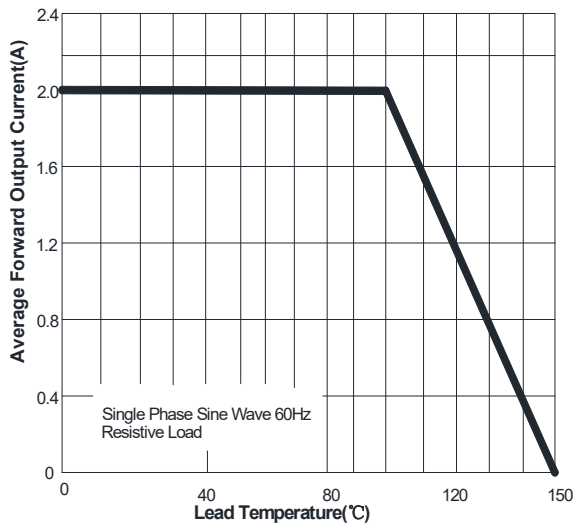

Fig2: Surge Forward Current Capability

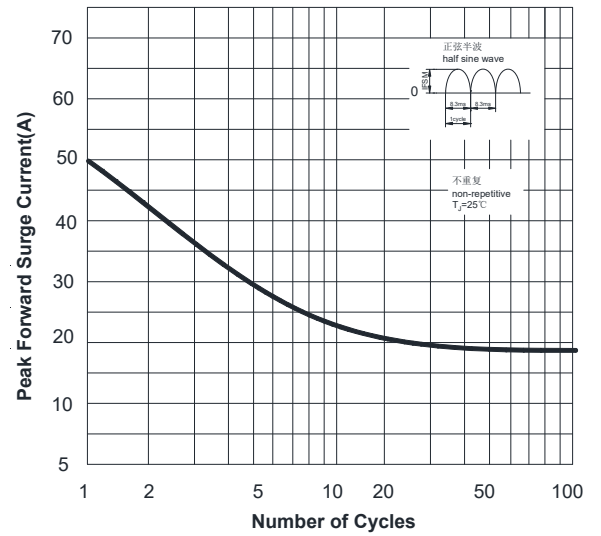

Fig3: Typical Forward Characteristics

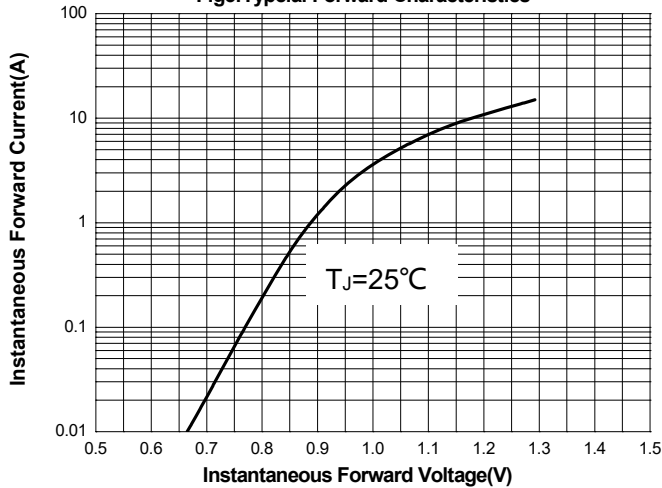
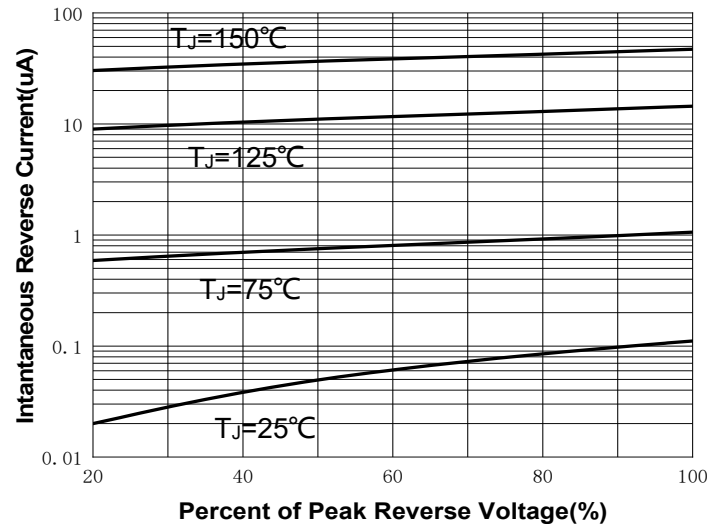

Fig4: Typical Reverse Characteristics





GS2AAQ THRU GS2MAQ

Fig5: Typical Junction Capacitance

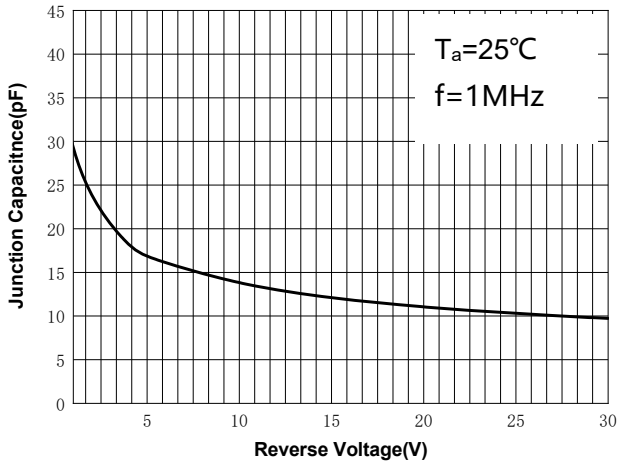

Ordering Information (Example)

PREFERRED P/N	PACKAGE CODE	UNIT WEIGHT(g)	MINIMUM PACKAGE(pcs)	INNER BOX QUANTITY(pcs)	OUTER CARTON QUANTITY(pcs)	DELIVERY MODE
GS2AAQ-GS2MAQ	F2	Approximate 0.067	7500	/	120000	13" reel

Outline Dimensions

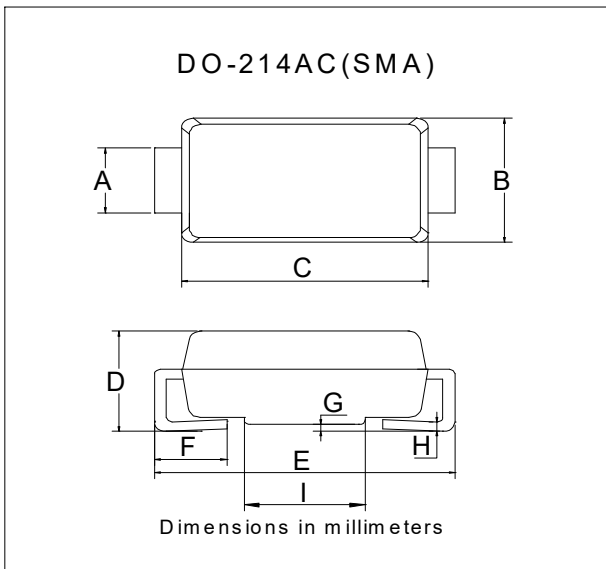

DO-214AC(SMA)		
Dim	Min	Max
A	1.25	1.58
B	2.40	2.83
C	4.00	4.75
D	1.90	2.30
E	4.93	5.28
F	0.76	1.41
G	0.05	0.20
H	0.15	0.31
I	1.7	2.1

Suggested Pad Layout

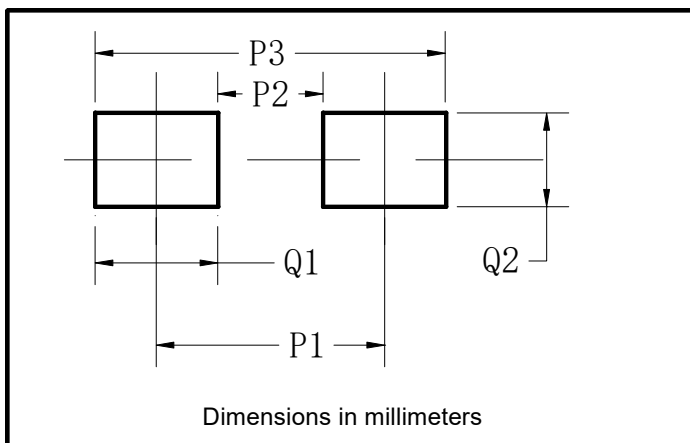

DO-214AC(SMA)	
Dim	Millimeters
P1	4.00
P2	1.50
P3	6.50
Q1	2.50
Q2	1.70



GS2AAQ THRU GS2MAQ

Disclaimer

The information presented in this document is for reference only. Yangzhou Yangjie Electronic Technology Co., Ltd. reserves the right to make changes without notice for the specification of the products displayed herein to improve reliability, function or design or otherwise.

The product listed herein is designed to be used with automotive electronics, are not designed for use in medical, lifesaving, lifesustaining, or military, Yangjie or anyone on its behalf, assumes no responsibility or liability for any damages resulting from such improper use of sale.

This publication supersedes & replaces all information previously supplied. For additional information, please visit our website [http:// www.21yangjie.com](http://www.21yangjie.com) , or consult your nearest Yangjie's sales office for further assistance.

X-ON Electronics

Largest Supplier of Electrical and Electronic Components

Click to view similar products for [Bridge Rectifiers](#) category:

Click to view products by [Yangjie](#) manufacturer:

Other Similar products are found below :

[MB2510](#) [MB252](#) [MB356G](#) [MB358G](#) [90MT160KPBF](#) [GBJ1504-BP](#) [GBU10B-BP](#) [GBU15K-BP](#) [GBU4A-BP](#) [GBU4D-BP](#) [GBU6B-E3/45](#)
[DB101-BP](#) [DF01](#) [DF10SA-E345](#) [BU1508-E3/45](#) [BU1510-E3/45](#) [KBPC50-10S](#) [RS405GL-BP](#) [GBJ1502-BP](#) [GBU6M](#) [GSIB1520-E3/45](#)
[2KBB10](#) [36MB140A](#) [TB102M](#) [MB1510](#) [MB86](#) [TL401G](#) [MDA920A2](#) [TU602](#) [TU810](#) [MP5010W-BP](#) [MP501W-BP](#) [MP502-BP](#)
[BR84DTP204](#) [BU1508-E3/51](#) [KBPC25-02](#) [VS-110MT120KPBF](#) [VS-2KBB60](#) [VS-60MT120KPBF](#) [VS-60MT80KPBF](#) [DB105-BP](#) [DF1510S](#)
[VS-40MT160PAPBF](#) [VISKBU8K-E4/51](#) [36MT100](#) [GBU4G-BP](#) [GBU6B-E3/51](#) [DF15005S-E3/77](#) [GSIB15A80-E3/45](#) [DB104-BP](#)