

## Surface Mount General Purpose Rectifier

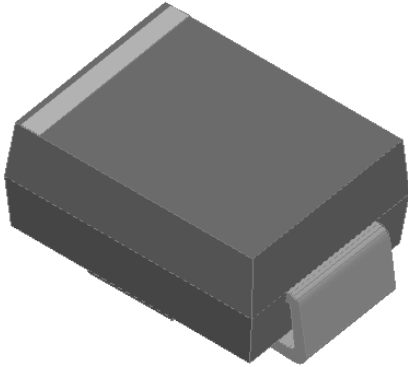

### Features

- Low profile package
- Ideal for automated placement
- Glass passivated chip junction
- High forward surge capability
- Meets MSL level 1, per J-STD-020, LF maximum peak of 260 °C
- Part no. with suffix "Q" means AEC-Q101 qualified

### Typical Applications

For use in general purpose rectification of power supplies, inverters, converters, and freewheeling diodes for consumer, automotive and telecommunication.

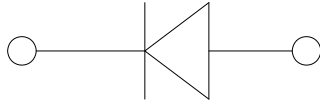

### Mechanical Data

- **Package:** DO-214AA (SMB)  
Molding compound meets UL 94 V-0 flammability rating, RoHS-compliant, halogen-free
- **Terminals:** Tin plated leads, solderable per J-STD-002 and JESD22-B102
- **Polarity:** Cathode line denotes the cathode end

### ■ Maximum Ratings (T<sub>a</sub>=25°C Unless otherwise specified)

PARAMETER	SYMBOL	UNIT	GS3ABQ	GS3BBQ	GS3DBQ	GS3GBQ	GS3JBQ	GS3KBQ	GS3MBQ
Device marking code			GS3AB	GS3BB	GS3DB	GS3GB	GS3JB	GS3KB	GS3MB
Repetitive peak reverse voltage	V <sub>RRM</sub>	V	50	100	200	400	600	800	1000
Maximum RMS voltage	V <sub>RMS</sub>	V	35	70	140	280	420	560	700
Average rectified output current @60Hz sine wave, resistance load, TL (FIG.1)	I <sub>o</sub>	A	3.0						
Surge(non-repetitive)forward current @60Hz half-sine wave,1 cycle, T <sub>a</sub> =25°C	I <sub>FSM</sub>	A	100						
Storage temperature	T <sub>stg</sub>	°C	-55~+150						
Junction temperature	T <sub>J</sub>	°C	-55~+150						

### ■ Electrical Characteristics (T<sub>a</sub>=25°C Unless otherwise specified)

PARAMETER	SYMBOL	UNIT	TEST CONDITIONS	GS3ABQ	GS3BBQ	GS3DBQ	GS3GBQ	GS3JBQ	GS3KBQ	GS3MBQ
Maximum instantaneous forward voltage drop per diode	V <sub>F</sub>	V	I <sub>FM</sub> =3.0A	1.15						
Typical junction capacitance	C <sub>J</sub>	pF	VR=4V,f=1 MHz	25						
Maximum DC reverse current at rated DC blocking voltage per diode @ V <sub>RM</sub> =V <sub>RRM</sub>	I <sub>RRM</sub>	μA	T <sub>a</sub> =25°C	5						
			T <sub>a</sub> =125°C	100						



# GS3ABQ THRU GS3MBQ

## ■ Thermal Characteristics (T<sub>a</sub>=25°C Unless otherwise specified)

PARAMETER	SYMBOL	UNIT	GS3ABQ	GS3BBQ	GS3DBQ	GS3GBQ	GS3JBQ	GS3KBQ	GS3MBQ
Thermal resistance	R <sub>θJ-A</sub>	°C/W	75 <sup>(1)</sup>						
	R <sub>θJ-L</sub>		20 <sup>(1)</sup>						

Note:  
 (1) Thermal resistance from junction to ambient and from junction to lead mounted on P.C.B. with 0.2" x 0.2" (5.0 mm x 5.0 mm) copper pad areas

## ■ Characteristics (Typical)

FIG1: I<sub>o</sub>-T<sub>L</sub> Curve

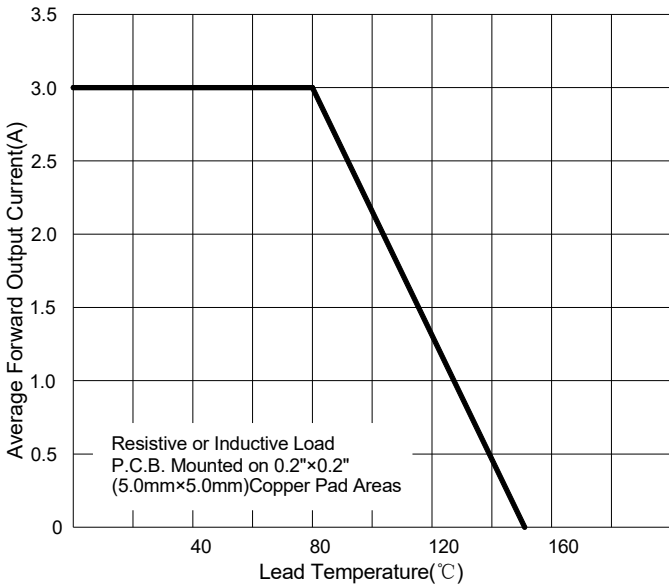

FIG2: Surge Forward Current Capability

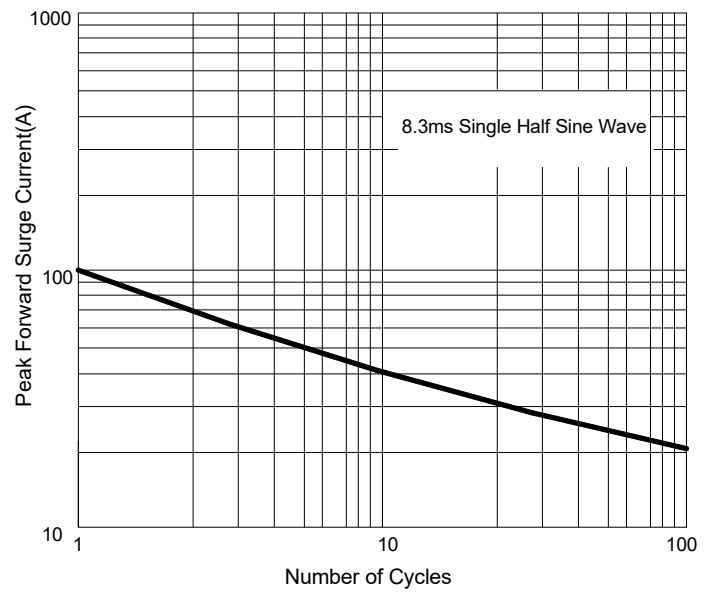

FIG.3: Typical Forward Characteristics

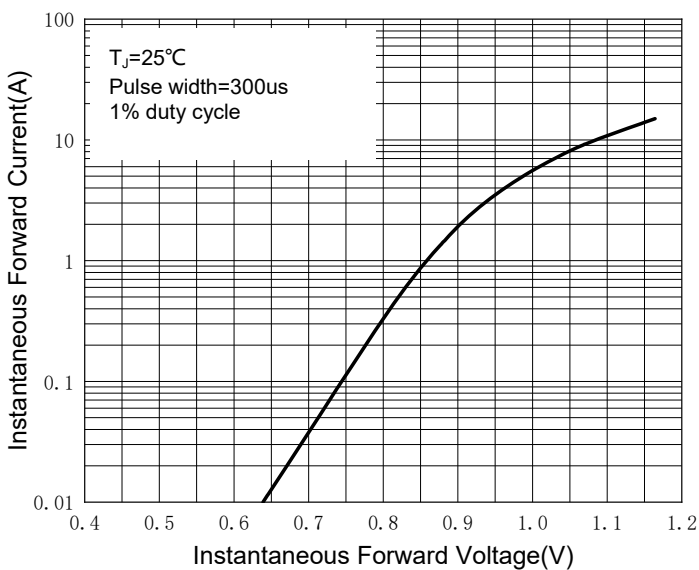
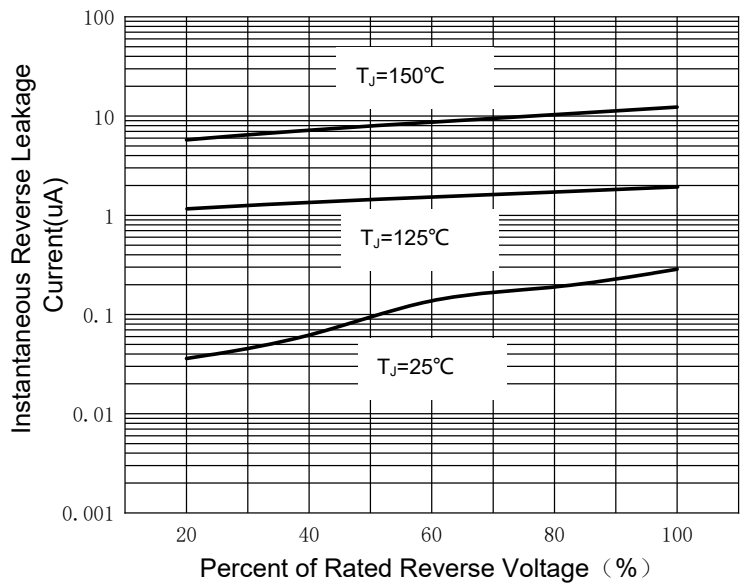

FIG.4: Typical Reverse Characteristics





# GS3ABQ THRU GS3MBQ

## Ordering Information (Example)

PREFERRED P/N	PACKING CODE	UNIT WEIGHT(g)	MINIMUM PACKAGE(pcs)	OUTER CARTON QUANTITY(pcs)	DELIVERY MODE
GS3ABQ-GS3MBQ	F1	Approximate 0.1003	3000	48000	13" reel

## Outline Dimensions

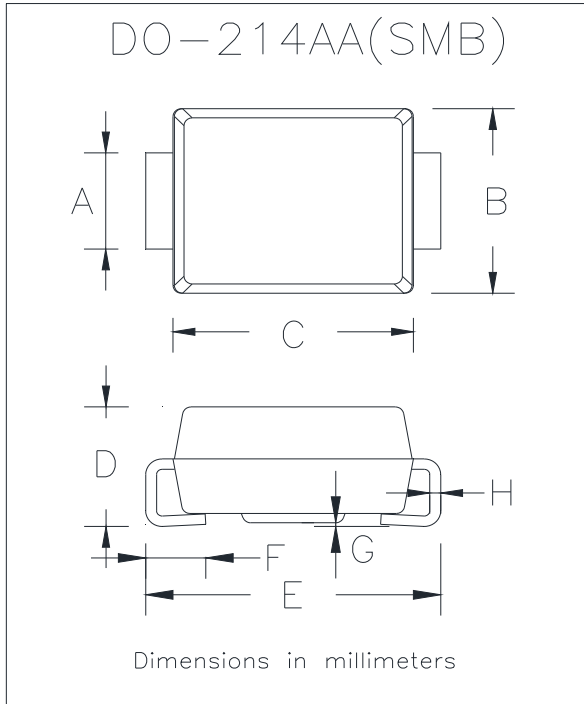

DO-214AA(SMB)		
Dim	Min	Max
A	1.85	2.15
B	3.30	3.94
C	4.05	4.75
D	1.99	2.61
E	5.21	5.59
F	0.90	1.41
G	0.05	0.20
H	0.15	0.31

## Suggested pad layout

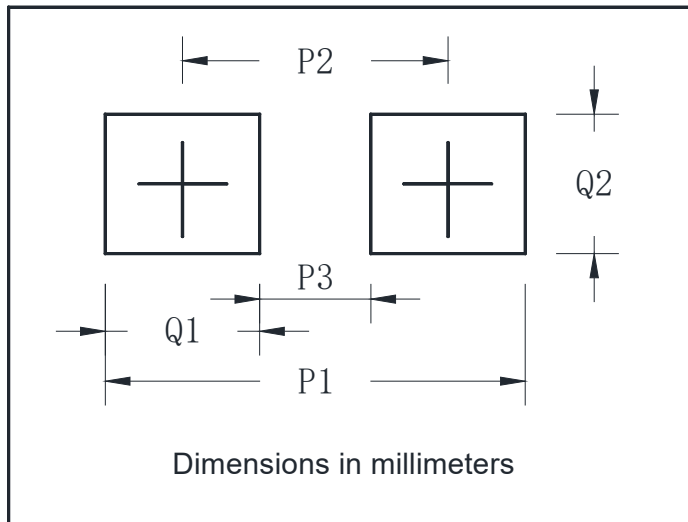

DO-214AA(SMB)	
Dim	Millimeters
P1	6.8
P2	4.3
P3	1.8
Q1	2.5
Q2	2.3



## GS3ABQ THRU GS3MBQ

---

### Disclaimer

The information presented in this document is for reference only. Yangzhou Yangjie Electronic Technology Co., Ltd. reserves the right to make changes without notice for the specification of the products displayed herein to improve reliability, function or design or otherwise.

The product listed herein is designed to be used with automotive electronics, are not designed for use in medical, lifesaving, lifesustaining, or military, Yangjie or anyone on its behalf, assumes no responsibility or liability for any damages resulting from such improper use of sale.

This publication supersedes & replaces all information previously supplied. For additional information, please visit our website [http:// www.21yangjie.com](http://www.21yangjie.com) , or consult your nearest Yangjie's sales office for further assistance.

## X-ON Electronics

Largest Supplier of Electrical and Electronic Components

*Click to view similar products for [Bridge Rectifiers](#) category:*

*Click to view products by [Yangjie](#) manufacturer:*

Other Similar products are found below :

[MB2510](#) [MB252](#) [MB356G](#) [MB358G](#) [GBJ1504-BP](#) [GBU10B-BP](#) [GBU15K-BP](#) [GBU4A-BP](#) [GBU4D-BP](#) [GBU6B-E3/45](#) [DB101-BP](#) [DF01](#)  
[DF10SA-E345](#) [BU1508-E3/45](#) [BU1510-E3/45](#) [KBPC50-10S](#) [RS405GL-BP](#) [GBJ1502-BP](#) [GBU6M](#) [GSIB1520-E3/45](#) [36MB140A](#) [TB102M](#)  
[MB1510](#) [MB86](#) [TL401G](#) [MDA920A2](#) [TU602](#) [TU810](#) [MP5010W-BP](#) [MP501W-BP](#) [MP502-BP](#) [BR84DTP204](#) [BU1508-E3/51](#) [KBPC25-02](#)  
[VS-110MT120KPBF](#) [VS-2KBB60](#) [VS-60MT120KPBF](#) [VS-60MT80KPBF](#) [DB105-BP](#) [DF1510S](#) [VS-40MT160PAPBF](#) [VISKBU8K-E4/51](#)  
[36MT100](#) [GBU4G-BP](#) [GBU6B-E3/51](#) [DF15005S-E3/77](#) [GSIB15A80-E3/45](#) [DB104-BP](#) [D3SB60](#) [TB354](#)