



## Glass Passivated Three Phase Rectifier Bridge

**VRRM** 800 to 1800V  
**ID** 100 A

### Applications

- Three phase rectifiers for power supplies
- Rectifiers for DC motor field supplies
- Battery charger rectifiers
- Input rectifiers for variable frequency drives

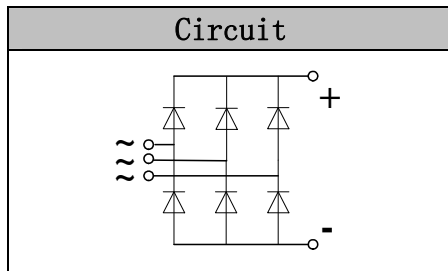

### Features

- Three phase bridge rectifier
- Blocking voltage:800 to 1800V
- Heat transfer through aluminum oxide DBC ceramic isolated metal baseplate
- Glass passivated chip

### Module Type

TYPE	VRRM	V <sub>RSM</sub>
MD100S08NM2	800V	900V
MD100S12NM2	1200V	1300V
MD100S16NM2	1600V	1700V
MD100S18NM2	1800V	1900V

### Maximum Ratings

Symbol	Conditions	Values	Units
$I_D$	Three phase, full wave $T_c=100^\circ\text{C}$	100	A
$I_{FSM}$	$t=10\text{mS}$ $T_{vj}=45^\circ\text{C}$	750	A
$i^2t$	$t=10\text{mS}$ $T_{vj}=45^\circ\text{C}$	4200	$\text{A}^2\text{s}$
$V_{isol}$	a.c.50HZ;r.m.s.;1min	3000	V
$T_{vj}$		-40 to +150	$^\circ\text{C}$
$T_{stg}$		-40 to +125	$^\circ\text{C}$
$M_t$	To terminals(M5)	$3\pm 15\%$	Nm
$M_s$	To heatsink(M5)	$3\pm 15\%$	Nm
Weight	Module (Approximately)	130	g

### Thermal Characteristics

Symbol	Conditions	Values	Units
$R_{th(j-c)}$	Per diode	1.0	$^\circ\text{C/W}$
$R_{th(c-s)}$	Module (Approximately)	0.07	$^\circ\text{C/W}$

### Electrical Characteristics

Symbol	Conditions	Values			Units
		Min.	Typ.	Max.	
$V_{FM}$	$T=25^\circ\text{C}$ $I_F=150\text{A}$	—	1.70	1.90	V
$I_{RD}$	$T_{vj}=25^\circ\text{C}$ $V_{RD}=V_{RRM}$	—	—	0.3	mA
	$T_{vj}=150^\circ\text{C}$ $V_{RD}=V_{RRM}$	—	—	5	mA

## Performance Curves

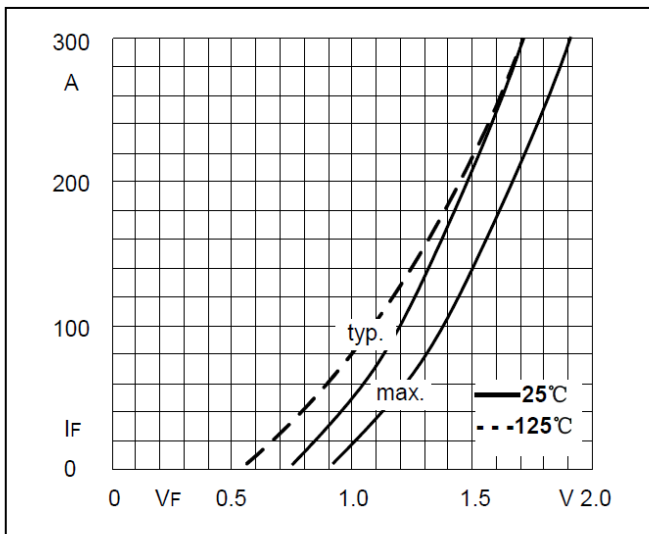

**Fig1. Forward Characteristics**

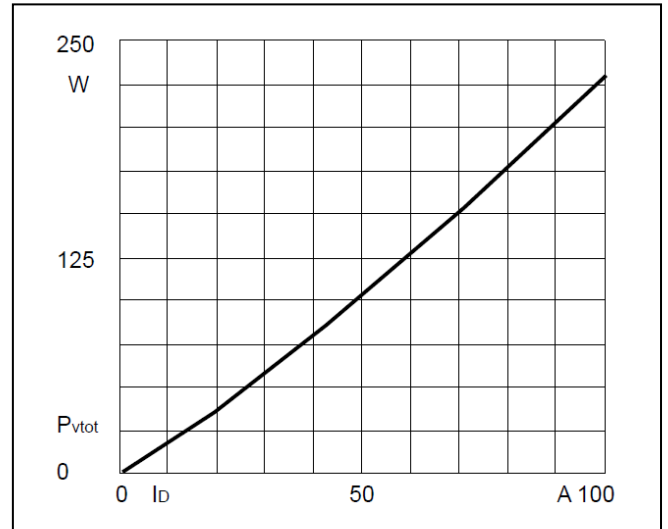

**Fig2. Power dissipation**

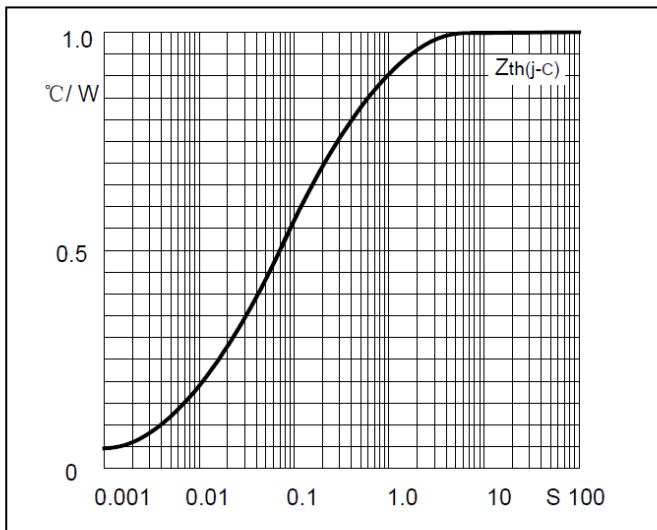

**Fig3. Transient thermal impedance**

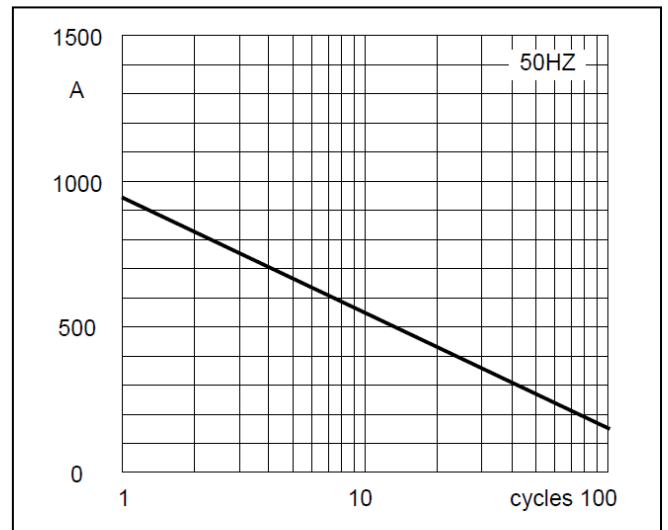

**Fig4. Max Non-Repetitive Forward Surge Current**

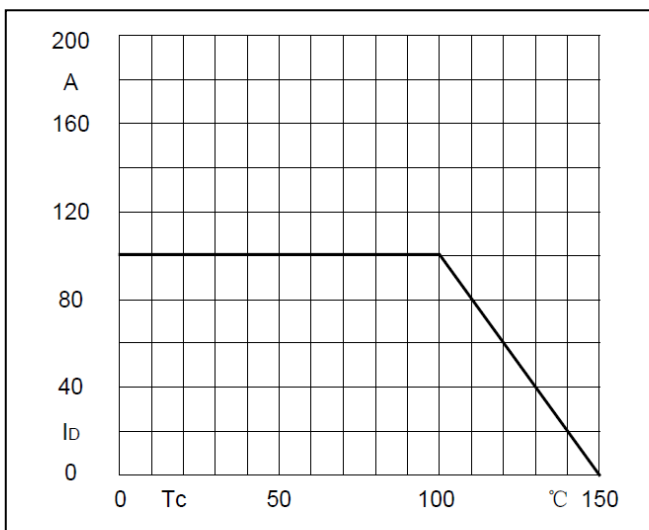

**Fig5. Forward Current Derating Curve**

## Package Outline Information

CASE: M2

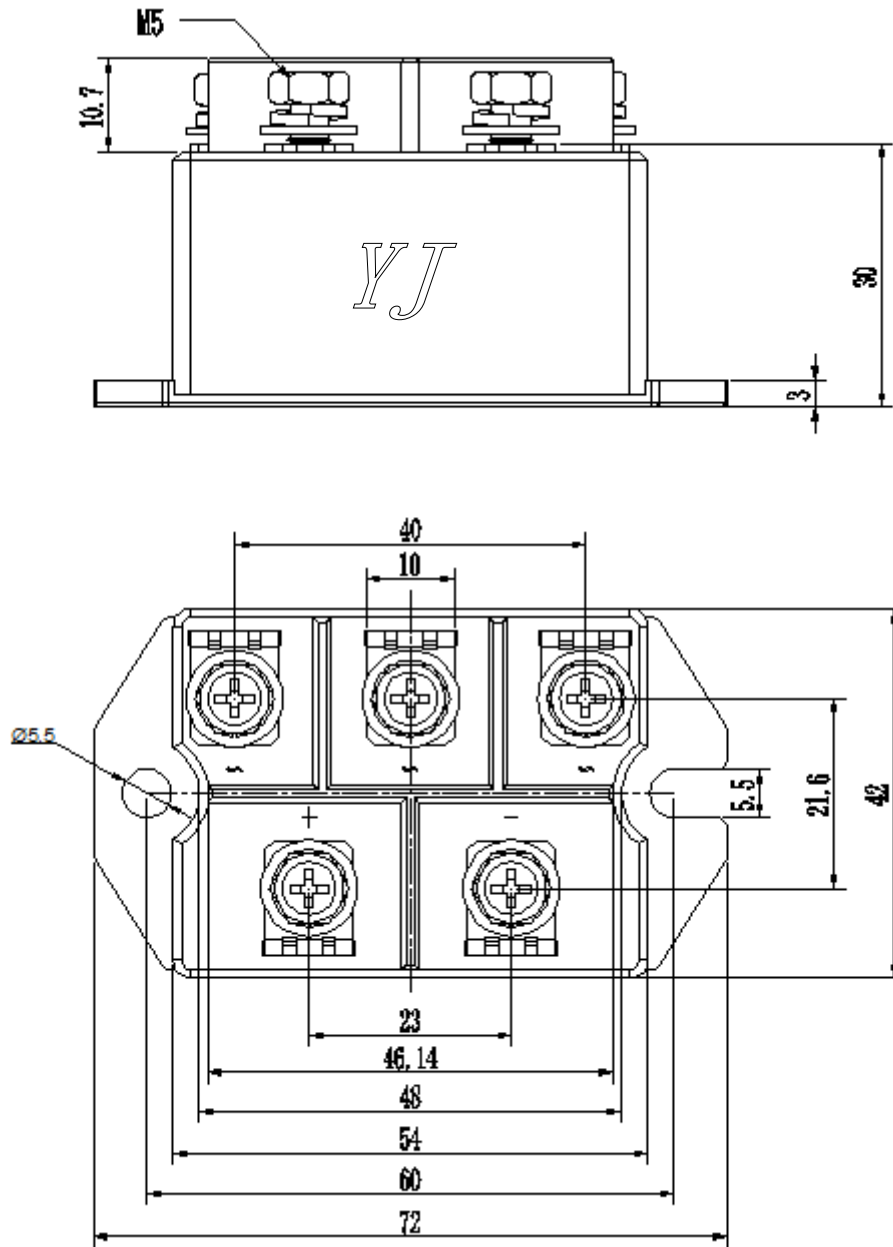

Dimensions in mm

## X-ON Electronics

Largest Supplier of Electrical and Electronic Components

*Click to view similar products for [Bridge Rectifiers](#) category:*

*Click to view products by [Yangjie](#) manufacturer:*

Other Similar products are found below :

[MB2510](#) [MB252](#) [MB356G](#) [MB358G](#) [GBJ1504-BP](#) [GBU10B-BP](#) [GBU15K-BP](#) [GBU4A-BP](#) [GBU4D-BP](#) [DB101-BP](#) [DF01](#) [DF10SA-E345](#)  
[KBPC50-10S](#) [RS405GL-BP](#) [GBJ1502-BP](#) [GBU6M](#) [TB102M](#) [MB1510](#) [MB86](#) [TL401G](#) [MDA920A2](#) [TU602](#) [TU810](#) [MP5010W-BP](#)  
[MP501W-BP](#) [MP502-BP](#) [KBPC25-02](#) [VBO160-12NO7](#) [VS-110MT120KPBF](#) [VS-60MT80KPBF](#) [DB105-BP](#) [DF1510S](#) [VS-](#)  
[40MT160PAPBF](#) [GBU4G-BP](#) [GSIB15A80-E3/45](#) [DB104-BP](#) [D3SB60](#) [TB354](#) [GBJ2504-BP](#) [26MB100A](#) [B1S-G](#) [VS-40MT160KPBF](#)  
[VUO162-16NO7](#) [ABS10-G](#) [GBU6B-BP](#) [GBJ1508-BP](#) [BR5010-G](#) [ABS6-G](#) [B125C800G-E4/51](#) [MSB15MH-13](#)