

## Glass Passivated Rectifier Diode Modules



**VRRM** 800 to 1800V  
**IFAV** 120 A

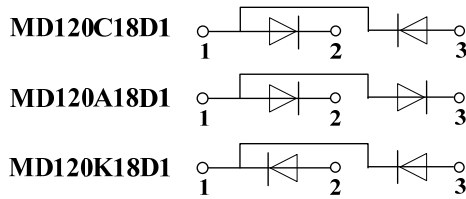
### Applications

- Non-controllable rectifiers for AC/AC converters
- Line rectifiers for transistorized AC motor controllers
- Field supply for DC motors

### Features

- Blocking voltage: 800 to 1800V
- Heat transfer through aluminum oxide DBC ceramic isolated metal baseplate
- Glass passivated chip
- UL recognized applied for file no. E360040

### Circuit



### Module Type

TYPE			VRRM	V <sub>RSM</sub>
MD120C08D1	MD120A08D1	MD120K08D1	800V	900V
MD120C12D1	MD120A12D1	MD120K12D1	1200V	1300V
MD120C16D1	MD120A16D1	MD120K16D1	1600V	1700V
MD120C18D1	MD120A18D1	MD120K18D1	1800V	1900V

### Maximum Ratings

Symbol	Conditions	Values	Units
IFAV	Single phase ,half wave 180° conduction Tc=106°C	120	A
IFSM	t=10mS Tvj =45°C	2800	A
i <sup>2</sup> t	t=10mS Tvj =45°C	39200	A <sup>2</sup> s
V <sub>isol</sub>	a.c.50HZ;r.m.s.;1min	3000	V
T <sub>vj</sub>		-40 to +150	°C
T <sub>stg</sub>		-40 to +125	°C
Mt	To terminals(M5)	3 ± 15%	Nm
Ms	To heatsink(M6)	5 ± 15%	Nm
Weight	Module (Approximately)	100	g

### Thermal Characteristics

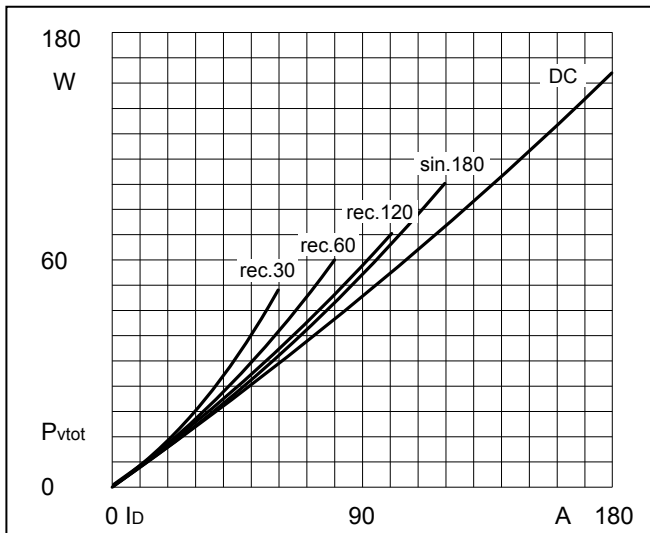
Symbol	Conditions	Values	Units
R <sub>th(j-c)</sub>	Per diode	0.26	°C/W
R <sub>th(j-c)</sub>	Per Module	0.13	°C/W
R <sub>th(c-s)</sub>	Per diode	0.2	°C/W
R <sub>th(c-s)</sub>	Per Module	0.1	°C/W



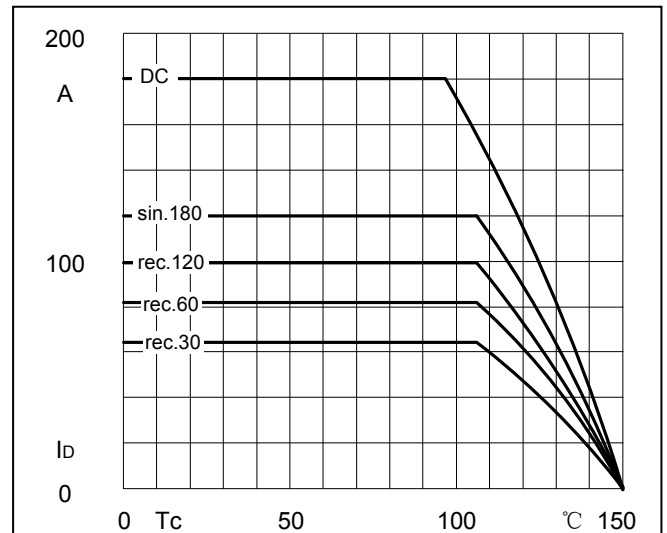
## Electrical Characteristics

Symbol	Conditions	Values			Units
		Min.	Typ.	Max.	
$V_{FM}$	$T=25^{\circ}C$ $I_F=300A$	—	1.20	1.35	V
$V_{FO}$	$T_J=25^{\circ}C$	—	0.87	—	V
	$T_J=150^{\circ}C$	—	0.69	—	V
$r_F$	$T_J=25^{\circ}C$	—	1.1	—	m $\Omega$
	$T_J=150^{\circ}C$	—	1.55	—	m $\Omega$
$I_{RD}$	$T_{vj}=150^{\circ}C$ $V_{RD}=V_{RRM}$	—	—	6	mA

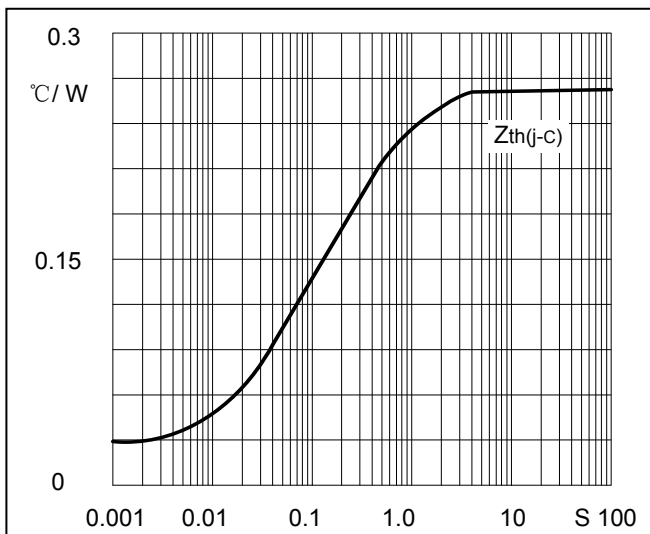
## Performance Curves



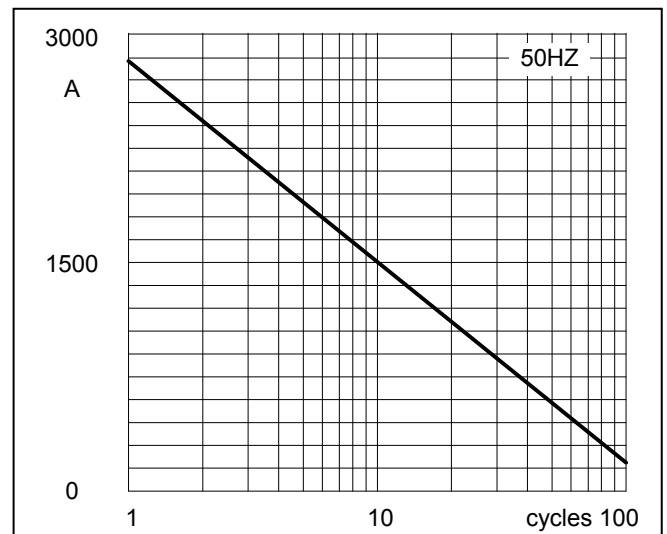
**Fig1. Power dissipation**



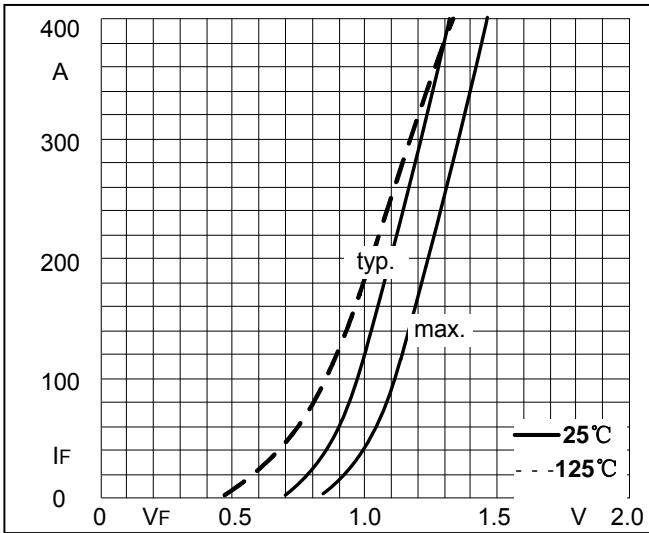
**Fig2. Forward Current Derating Curve**



**Fig3. Transient thermal impedance**

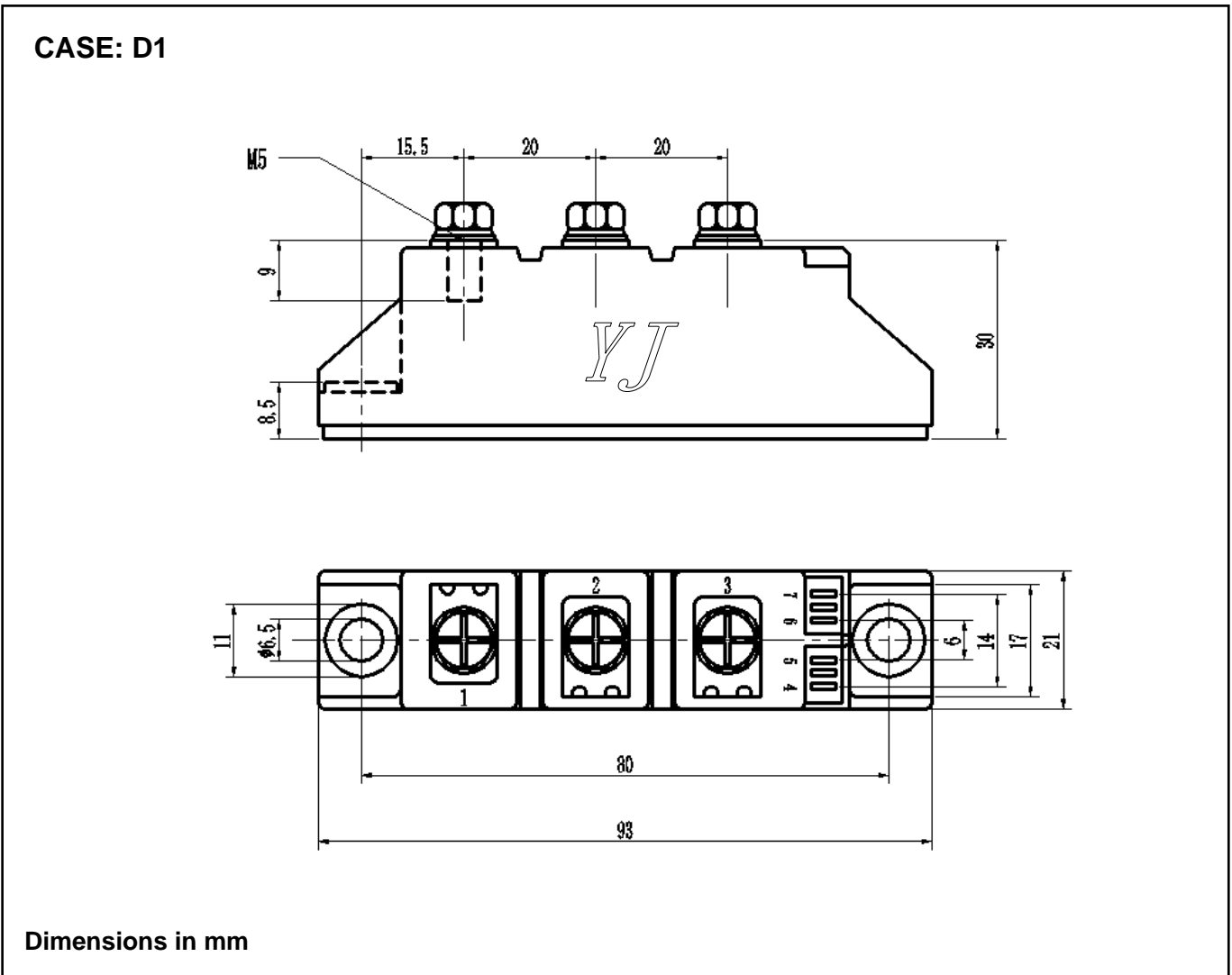


**Fig4. Max Non-Repetitive Forward Surge Current**



**Fig5. Forward Characteristics**

### Package Outline Information



## X-ON Electronics

Largest Supplier of Electrical and Electronic Components

*Click to view similar products for yangjie manufacturer:*

Other Similar products are found below :

[BR25005](#) [BR2501](#) [BR2506](#) [BZV55C12](#) [BZX55C10](#) [BZX55C4V7](#) [BR2504L](#) [MD200K16D2-A1-0000](#) [MD200S12M3-A1-0000](#)  
[MD200A16D2-A1-0000](#) [MF200DU04FJ-A2-0000](#) [MD165U16D2-A1-0000](#) [MD100S12M4-A1-0000](#) [KBPC3506](#) [MF150C06F5](#)  
[MD165C16D2](#) [MD100S16M5-A1-0000](#) [MD200S18M3-A1-0000](#) [MD100S12M3-A1-0000](#) [MD130S12M5-A1-0000](#) [MD75S18M4-A1-0000](#)  
[MD100S08M3-A1-0000](#) [MD250S12NM3-A1-0000](#) [MD250S16NM3-A1-0000](#) [MT100DT08L1-A1-0000](#) [MT100DT18L1-A1-0000](#)  
[MD100S08M5-A1-0000](#) [MT75DT08L1-A1-0000](#) [MD130S16M3-A1-0000](#) [MD160S18M5-A1-0000](#) [MD160S08M3-A1-0000](#) [MD160S08M5-](#)  
[A1-0000](#) [MD50S16M4-A1-0000](#) [MD100S18M4-A1-0000](#) [MD250S18M3-A1-0000](#) [MT160C18T2-A1-0000](#) [MD100S16M3-A1-0000](#)  
[MT75DT16L1-A1-0000](#) [MD100S12M5-A1-0000](#) [MD100S16NM3-A1-0000](#) [MD100S18M8-A1-0000](#) [MT100DT12L1-A1-0000](#)  
[MT75DT18L1-A1-0000](#) [MD100S18M3-A1-0000](#) [MD100S18M5-A1-0000](#) [MD130S16M5-A1-0000](#) [MD160S16NM3-A1-0000](#)  
[MD160S18NM3-A1-0000](#) [MD130S08M3-A1-0000](#) [MD100S08M2-A1-0000](#)