



## Glass Passivated Three Phase Rectifier Bridge

**VRRM** 800 to 2400V  
**ID** 50 A

### Applications

- Three phase rectifiers for power supplies
- Rectifiers for DC motor field supplies
- Battery charger rectifiers
- Input rectifiers for variable frequency drives

### Features

- Three phase bridge rectifier
- Blocking voltage:800 to 2400V
- Heat transfer through aluminum oxide DBC ceramic isolated metal baseplate
- Glass passivated chip

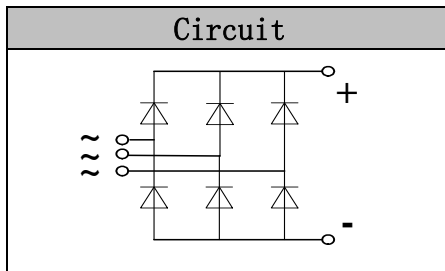

### Module Type

TYPE	VRRM	VRSM
MD50S08M4	800V	900V
MD50S12M4	1200V	1300V
MD50S16M4	1600V	1700V
MD50S18M4	1800V	1900V
MD50S20M4	2000V	2100V
MD50S22M4	2200V	2300V
MD50S24M4	2400V	2500V

### Maximum Ratings

Symbol	Conditions	Values	Units
ID	Three phase, full wave Tc=110°C	50	A
IFSM	t=10mS Tvj =45°C	460	A
i <sup>2</sup> t	t=10mS Tvj =45°C	1050	A <sup>2</sup> s
Visol	a.c.50HZ;r.m.s.;1min	3000	V
Tvj		-40 to +125	°C
Tstg		-40 to +125	°C
Mt	To terminals(M5)	5±15%	Nm
Ms	To heatsink(M5)	5±15%	Nm
Weight	Module (Approximately)	146	g

### Thermal Characteristics

Symbol	Conditions	Values	Units
Rth(j-c)	Per diode	1.45	°C/W
Rth(c-s)	Module	0.07	°C/W



**Electrical Characteristics**

Symbol	Conditions	Values			Units
		Min.	Typ.	Max.	
V <sub>FM</sub>	T=25°C I <sub>F</sub> =150A	—	1.45	1.7	V
I <sub>RD</sub>	T <sub>vj</sub> =25°C V <sub>RD</sub> =V <sub>R<sub>RM</sub></sub> T <sub>vj</sub> =150°C V <sub>RD</sub> =V <sub>R<sub>RM</sub></sub>	—	—	0.3 5	mA mA

**Performance Curves**

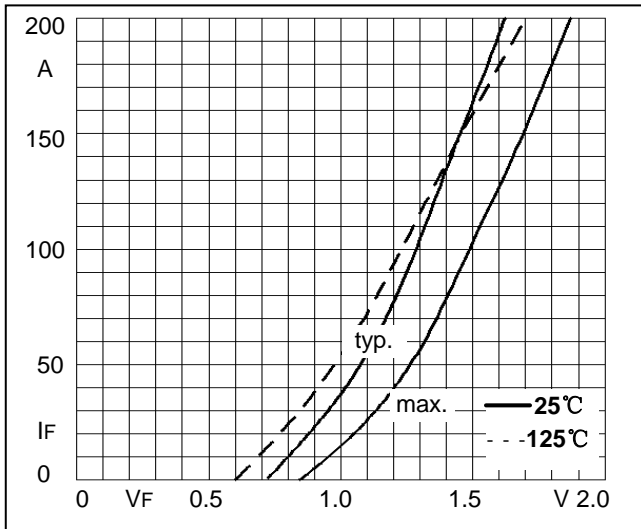

**Fig1. Forward Characteristics**

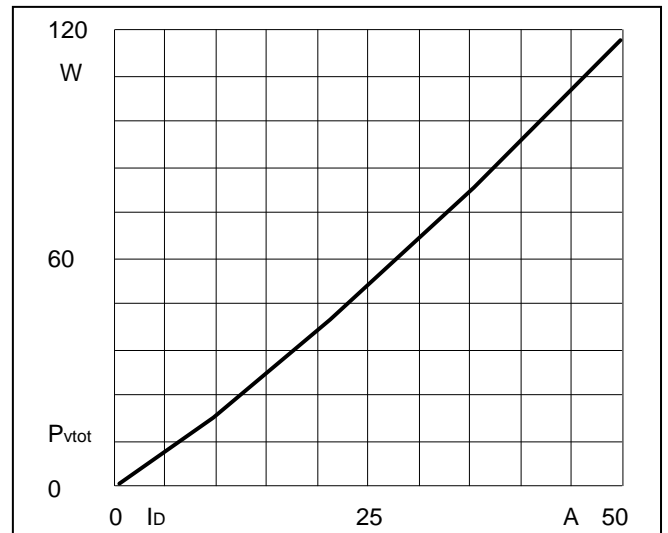

**Fig2. Power dissipation**

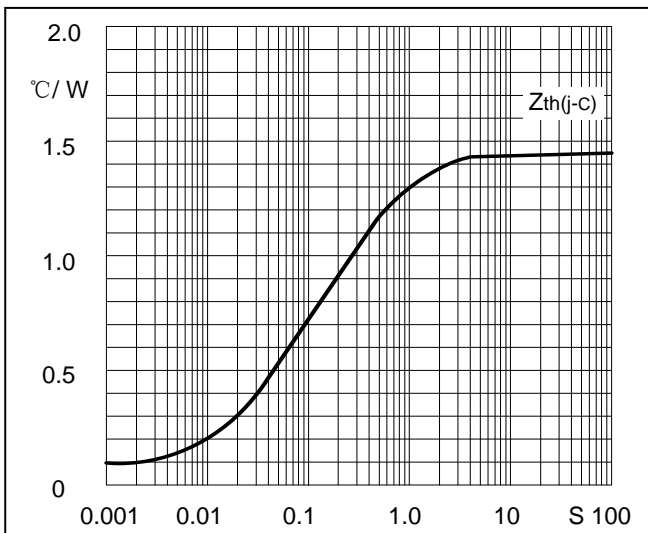

**Fig3. Transient thermal impedance**

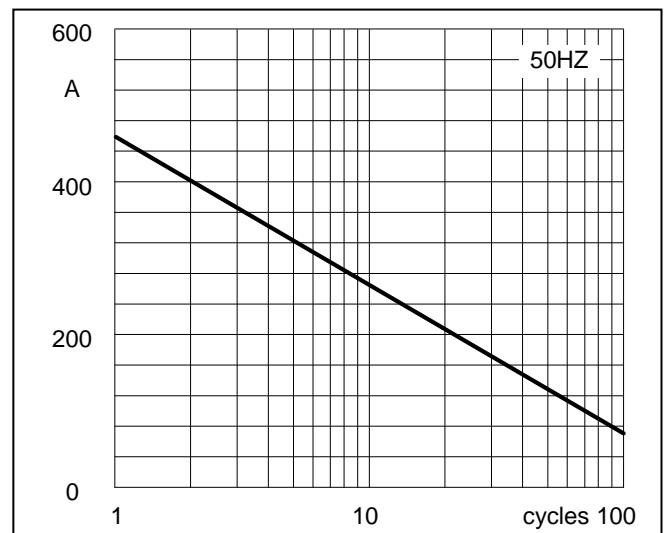

**Fig4. Max Non-Repetitive Forward Surge Current**

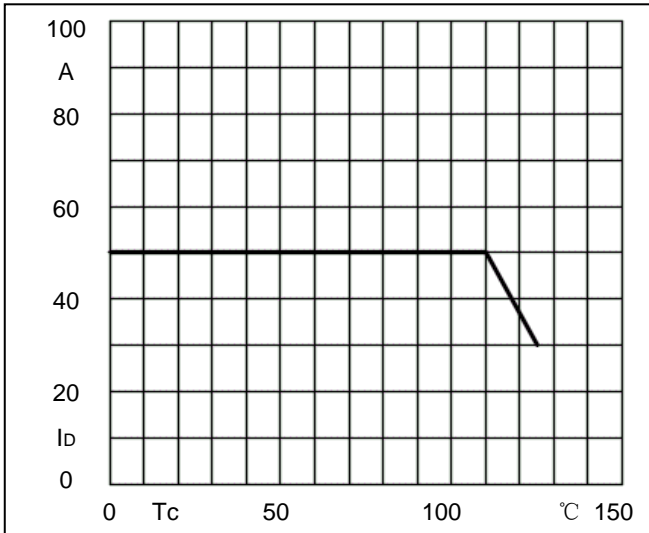
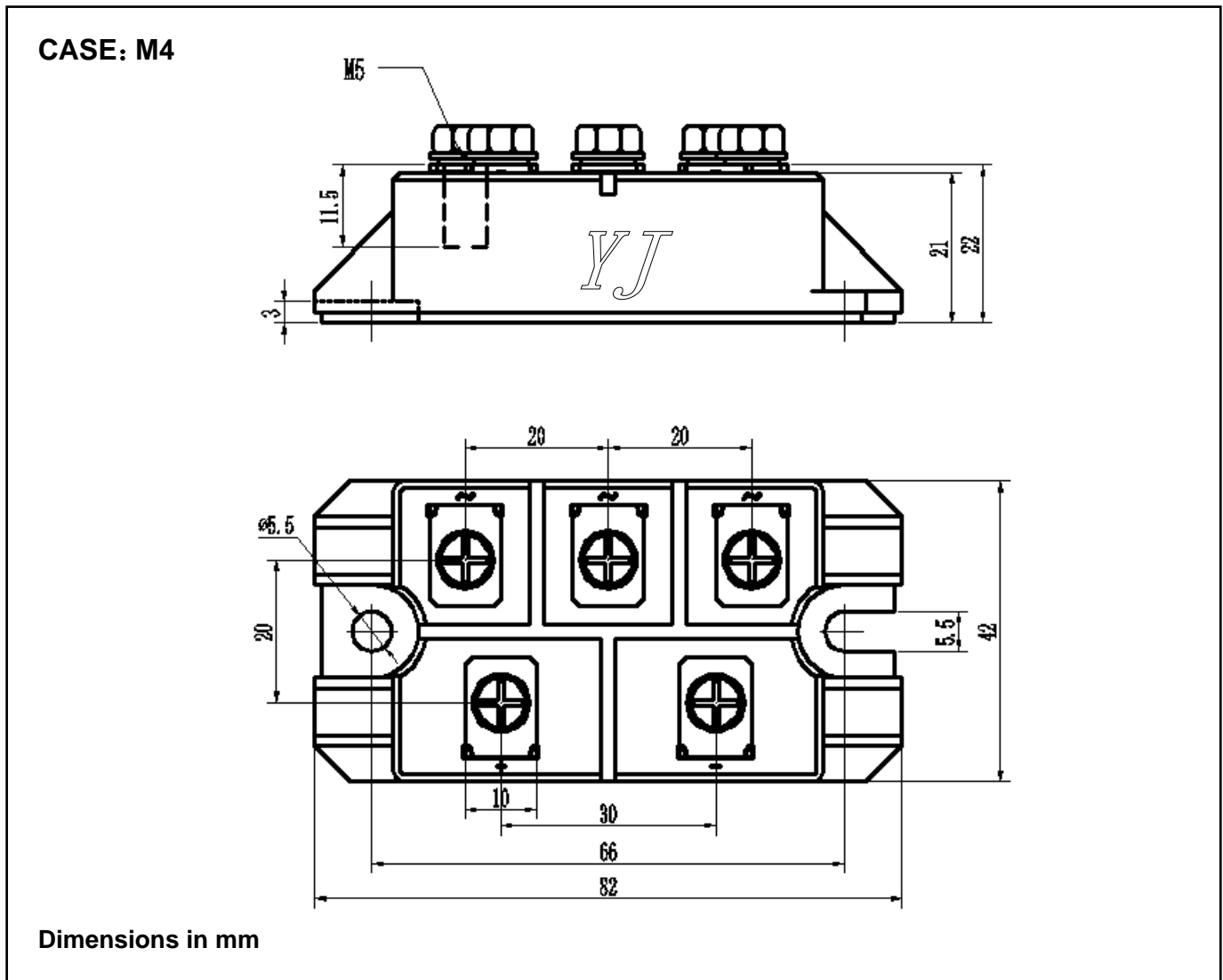

Fig5.Forward Current Derating Curve

### Package Outline Information



## X-ON Electronics

Largest Supplier of Electrical and Electronic Components

*Click to view similar products for [Bridge Rectifiers](#) category:*

*Click to view products by [Yangjie](#) manufacturer:*

Other Similar products are found below :

[G3SBA60-E351](#) [GBJ1504-BP](#) [GBU10B-BP](#) [GBU15J-BP](#) [GBU15K-BP](#) [GBU4A-BP](#) [GBU4D-BP](#) [GBU6B-E3/45](#) [GSIB680-E3/45](#) [DB101-BP](#) [DF10SA-E345](#) [RMB2S](#) [RCG](#) [APT30DF100HJ](#) [APT60DF20HJ](#) [B2S-E3/80](#) [BU1506-E351](#) [BU15085S-E345](#) [BU1508-E3/45](#) [BU1510-E3/45](#) [RS404GL-BP](#) [RS405GL-BP](#) [G3SBA20-E3/51](#) [G5SBA20-E3/51](#) [G5SBA60-E3/51](#) [GBJ1502-BP](#) [GBL02-E351](#) [GBL10-E3/45](#) [GBU10J-BP](#) [GBU4J-BP](#) [GBU4K-BP](#) [GBU8B-E3/45](#) [GBU8D-BP](#) [GBU8J-BP](#) [GSIB1520-E3/45](#) [MB1510](#) [MB352W](#) [MB6M-G](#) [B2M-E345](#) [B40C7000A](#) [B500C7000A](#) [MP5010W-BP](#) [MP501W-BP](#) [MP502-BP](#) [BR1005-BP](#) [BR101-BP](#) [BU1006-E345](#) [BU12065S-E3/45](#) [BU1508-E3/51](#) [BU2006-E3/45](#) [BU2008-E345](#)