

PNP General Purpose Amplifier

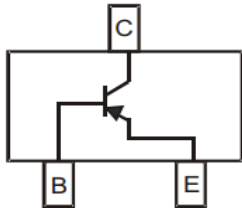

SOT-23

Features

- Epoxy meets UL-94 V-0 flammability rating and halogen free
- Moisture Sensitivity Level 1
- Part no. with suffix "Q" means AEC-Q101 qualified

Mechanical Data

- **Case:** SOT-23
- **Terminals:** Tin plated leads, solderable per J-STD-002 and JESD22-B102
- **Marking:**

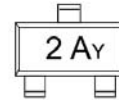

2A = Product Type Marking Code
Y = Date Code Marking

Date code Ke (years a cycle)

Year	Odd years (e.g. 2019)											
Month	Jan	Feb	Mar	Apr	May	Jun	Jul	Aug	Sep	Oct	Nov	Dec
Code	J	O	L	C	K	B	P	D	M	E	G	F

Year	Even years (e.g. 2018)											
Month	Jan	Feb	Mar	Apr	May	Jun	Jul	Aug	Sep	Oct	Nov	Dec
Code	W	N	Y	T	R	H	A	I	U	X	Z	S

■ Maximum Ratings (Ta=25°C unless otherwise noted)

Item	Symbol	Unit	Conditions	Value
Collector-Base Voltage	V_{CBO}	V		-40
Collector-Emitter Voltage	V_{CEO}	V		-40
Emitter-Base Voltage	V_{EBO}	V		-5
Collector Current -Continuous	I_C	mA		-200
Total Device Dissipation (*)	P_D	mW		300
Thermal Resistance Junction to Ambient (*)	R_{thJA}	K/W		417
Junction Temperature	T_j	°C		-55 to +150
Storage Temperature	T_{STG}	°C		-55 to +150

(*) Device mounted on FR-4 PCB 1.0 x 1.0 x 0.06 inch.



■ Electrical Characteristics (Ta=25°C unless otherwise noted)

Item	Symbol	Unit	Conditions	Min	Max
Collector-emitter breakdown voltage	$V_{(BR)CEO}$	Vdc	$I_C = -1\text{mA}, I_B = 0$	-40	
Collector-base breakdown voltage	$V_{(BR)CBO}$	Vdc	$I_C = -10\mu\text{A}, I_E = 0$	-40	
Emitter-base breakdown voltage	$V_{(BR)EBO}$	Vdc	$I_E = -10\mu\text{A}, I_C = 0$	-5	
Collector cut-off current	I_{CBO}	μA	$V_{CB} = -40\text{Vdc}, I_E = 0$		-0.1
Collector cut-off current	I_{CEX}	nA	$V_{CE} = -30\text{Vdc}, V_{EB} = -3.0\text{Vdc}$		-50
Emitter cut-off current	I_{EBO}	μA	$V_{EB} = -5\text{Vdc}, I_C = 0$		-0.1
DC current gain	h_{FE}		$V_{CE} = -1\text{Vdc}, I_C = -0.1\text{mA}$	40	
	h_{FE}		$V_{CE} = -1\text{Vdc}, I_C = -1.0\text{mA}$	70	
	h_{FE}		$V_{CE} = -1\text{Vdc}, I_C = -10\text{mA}$	100	300
	h_{FE}		$V_{CE} = -1\text{Vdc}, I_C = -50\text{mA}$	60	
	h_{FE}		$V_{CE} = -1\text{Vdc}, I_C = -100\text{mA}$	30	
Collector-emitter saturation voltage	$V_{CE(sat)}$	Vdc	$I_C = -10\text{mA}, I_B = -1.0\text{mA}$		-0.25
			$I_C = -50\text{mA}, I_B = -5.0\text{mA}$		-0.4
Base-emitter saturation voltage	$V_{BE(sat)}$	Vdc	$I_C = -10\text{mA}, I_B = -1.0\text{mA}$	-0.65	-0.85
			$I_C = -50\text{mA}, I_B = -5.0\text{mA}$		-0.95
Output Capacitance	C_{obo}	pF	$V_{CB} = -5.0\text{Vdc}, f = 1.0\text{MHz}, I_E = 0$		4.5
Input Capacitance	C_{ibo}	pF	$V_{EB} = -5.0\text{Vdc}, f = 1.0\text{MHz}, I_C = 0$		10
Delay time	t_d	ns	$V_{CC} = -3.0\text{Vdc}, V_{BE} = -0.5\text{Vdc}, I_C = -10\text{mA}, I_{B1} = -1.0\text{mA}$		35
Rise time	t_r	ns			35
Storage time	t_s	ns	$V_{CC} = -3.0\text{Vdc}, I_C = -10\text{mA}, I_{B1} = I_{B2} = -1.0\text{mA}$		225
Fall time	t_f	ns			75

■ Ordering Information (Example)

PREFERRED P/N	PACKING CODE	UNIT WEIGHT(g)	MINIMUM PACKAGE(pcs)	INNER BOX QUANTITY(pcs)	OUTER CARTON QUANTITY(pcs)	DELIVERY MODE
MMBT3906Q	F2	Approximate 0.01	3000	30000	120000	7" reel



■ Characteristics (Typical)

Fig.1 - Static Characteristic

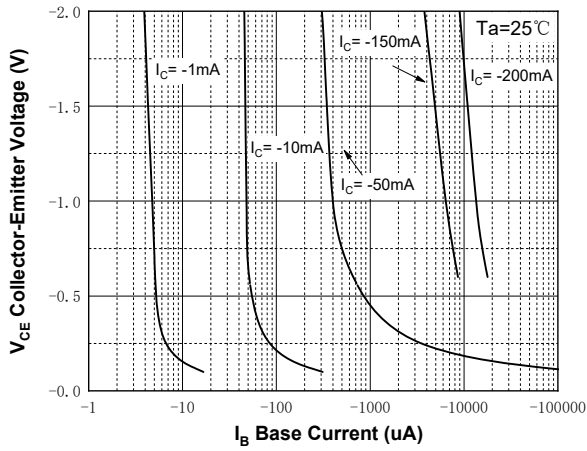

Fig.2 - DC Current Gain

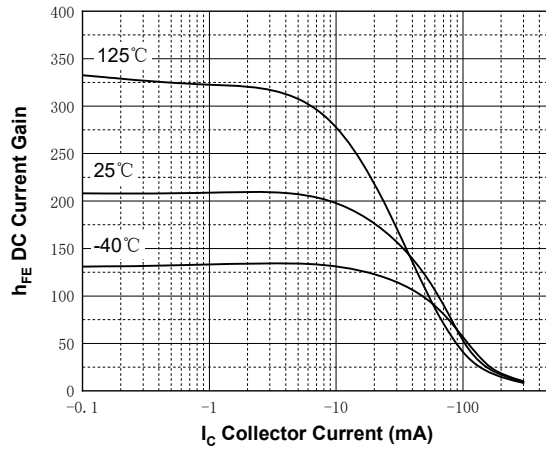

Fig.3 - Collector-Emitter Saturation Voltage

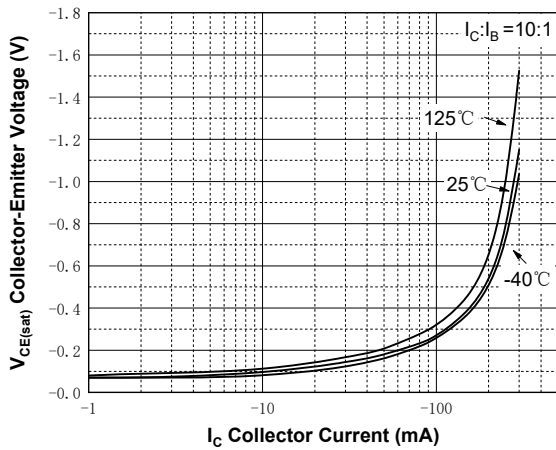

Fig.4 - Base-Emitter Saturation Voltage

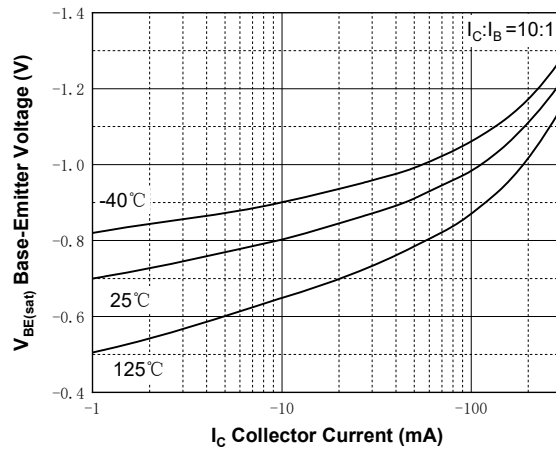
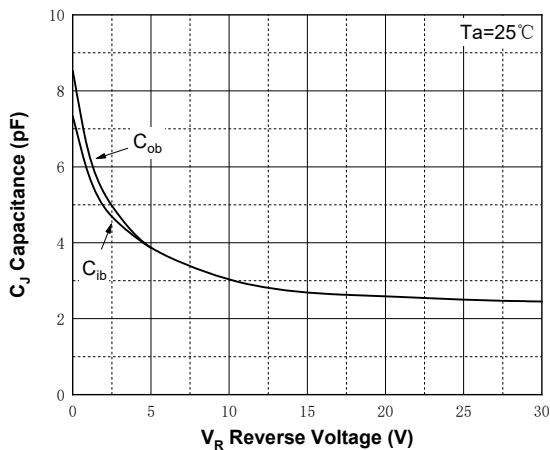
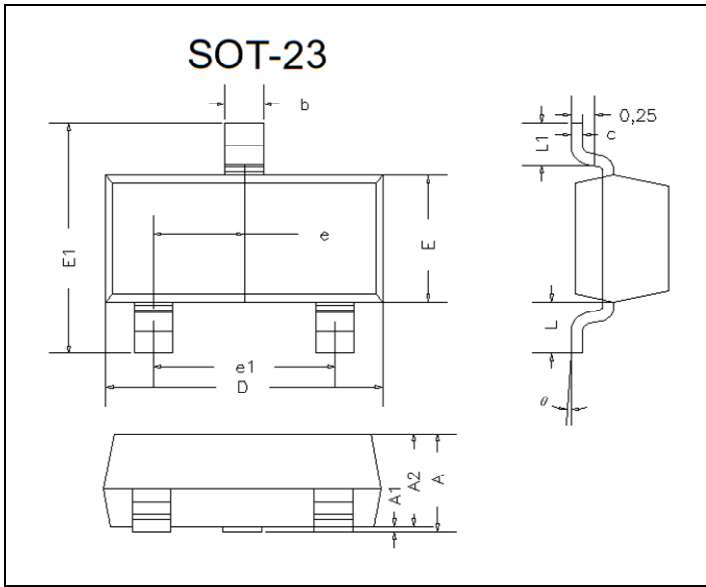

Fig.5 - Capacitance



■ SOT-23 Package Outline Dimensions



DIM	INCHES		MM		NOTE
	MIN	MAX	MIN	MAX	
A	0.035	0.045	0.90	1.15	
A1	0.000	0.004	0.00	0.10	
A2	0.035	0.041	0.90	1.05	
b	0.012	0.020	0.30	0.50	
c	0.004	0.008	0.10	0.20	
D	0.110	0.118	2.80	3.00	
E	0.047	0.055	1.20	1.40	
E1	0.089	0.100	2.25	2.55	
e	0.370TYP		0.95TYP		
e1	0.071	0.079	1.80	2.00	
L	0.220REF		0.55REF		
L1	0.012	0.020	0.30	0.50	
θ	0°	8°	0°	8°	

■ SOT-23 Suggested Pad Layout

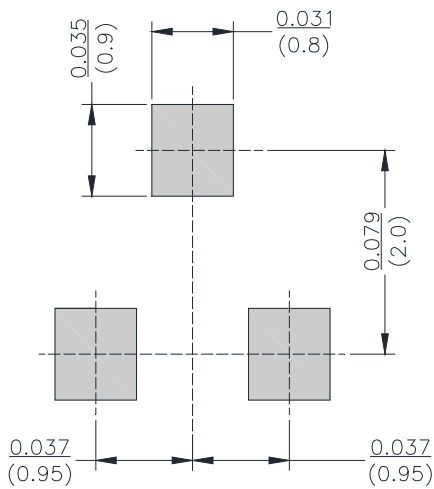

Unit: $\frac{\text{inch}}{\text{mm}}$

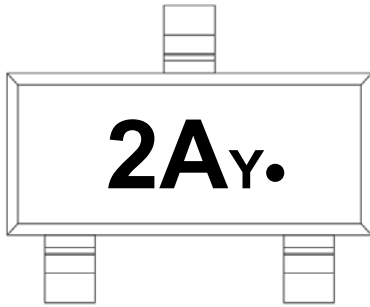
■ Marking Information**Note:**

1. All marking is at middle of the product body
2. All marking is in laser marking
3. 2AY is Marking Code determined by specific date
4. Body color: Black



Disclaimer

The information presented in this document is for reference only. Yangzhou Yangjie Electronic Technology Co., Ltd. reserves the right to make changes without notice for the specification of the products displayed herein to improve reliability, function or design or otherwise.

The product listed herein is designed to be used with automotive electronics, are not designed for use in medical, life-saving, life-sustaining, or military. Yangjie or anyone on its behalf, assumes no responsibility or liability for any damages resulting from such improper use of sale.

This publication supersedes & replaces all information previously supplied. For additional information, please visit our website [http:// www.21yangjie.com](http://www.21yangjie.com) , or consult your nearest Yangjie's sales office for further assistance.

X-ON Electronics

Largest Supplier of Electrical and Electronic Components

Click to view similar products for [Bipolar Transistors - BJT category](#):

Click to view products by [Yangjie manufacturer](#):

Other Similar products are found below :

[BC559C](#) [MCH4017-TL-H](#) [MMBT-2369-TR](#) [BC546/116](#) [NJVMJD148T4G](#) [NTE16](#) [NTE195A](#) [IMX9T110](#) [2N4401-A](#) [2N6728](#) [2SA1419T-TD-H](#) [2SB1204S-TL-E](#) [2SC5488A-TL-H](#) [FMC5AT148](#) [2N2369ADCSM](#) [2N2907A](#) [2N3904-NS](#) [2N5769](#) [2SC4618TLN](#) [CPH6501-TL-E](#) [BC856BW-13-F](#) [US6T6TR](#) [BAX18/A52R](#) [BC556/112](#) [IMZ2AT108](#) [MMST8098T146](#) [MCH6102-TL-E](#) [2N3879](#) [30A02MH-TL-E](#) [NTE13](#) [NTE282](#) [NTE323](#) [NTE350](#) [NTE81](#) [JANTX2N2920L](#) [JANSR2N2907AUB](#) [CMLT3946EG TR](#) [SNSS40600CF8T1G](#) [CMLT3906EG TR](#) [GRP-DATA-JANS2N2907AUB](#) [GRP-DATA-JANS2N2222AUA](#) [MMDT3946FL3-7](#) [2N4240](#) [JANS2N3019](#) [MSB30KH-13](#) [2N2221AUB](#) [2SD1815T-TL-E](#) [2N6678](#) [2N2907Ae4](#) [JAN2N3507](#)