

Ultra-Fast Recovery Rectifier Diodes

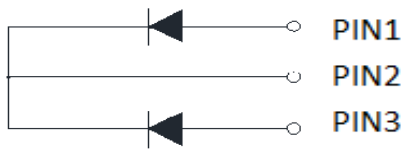
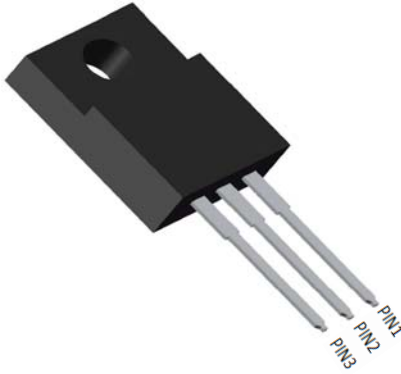

Features

- High frequency operation
- High surge forward current capability
- High purity, high temperature epoxy encapsulation for enhanced mechanical strength and moisture resistance
- Guard ring for enhanced ruggedness and long term reliability
- Solder dip 275 °C max. 7 s, per JESD 22-B106

Typical Applications

Typical applications are in switching power supplies, converters, freewheeling diodes, and reverse battery protection.

Mechanical Data

- **Package:** ITO-220AB
Molding compound meets UL 94 V-0 flammability rating, RoHS-compliant
- **Terminals:** Tin plated leads, solderable per J-STD-002 and JESD22-B102
- **Polarity:** As marked

■Maximum Ratings (T_a=25°C Unless otherwise specified)

PARAMETER	SYMBOL	UNIT	MUR2040FCT	MUR2060FCT
Device marking code			MUR2040FCT	MUR2060FCT
Repetitive Peak Reverse Voltage	V _{RRM}	V	400	600
Average Rectified Output Current @60Hz half sine-wave, R-load, T _c (FIG.1)	I _o	A	20	
Surge(Non-repetitive)Forward Current @60Hz half sine-wave, 1 cycle, T _a =25°C	I _{FSM}	A	125	
Current Squared Time @1ms≤t≤8.3ms T _j =25°C, Rating of per diode	I ² t	A ² s	65	
Storage Temperature	T _{stg}	°C	-55 ~ +150	
Junction Temperature	T _j	°C	-55 ~ +150	

■Electrical Characteristics (T_a=25°C Unless otherwise specified)

PARAMETER	SYMBOL	UNIT	TEST CONDITIONS	MUR2040FCT	MUR2060FCT
Maximum instantaneous forward voltage drop per diode	V _{FM}	V	I _{FM} =10.0A	1.3	1.5
Maximum DC reverse current at rated DC blocking voltage per diode	I _{RRM1}	uA	V _{RM} =V _{RRM} T _a =25°C	10	
	I _{RRM2}		V _{RM} =V _{RRM} T _a =125°C	500	
Reverse Recovery Time	T _{rr}	ns	I _F =0.5A I _{RM} =1A I _{RR} =0.25A	50	

■Thermal Characteristics (T_a=25°C Unless otherwise specified)

PARAMETER	SYMBOL	UNIT	MUR2040FCT	MUR2060FCT
Thermal Resistance Between junction and case	R _{θj-c}	°CW	2.5	



MUR2040FCT THUR MUR2060FCT

Ordering Information (Example)

PREFERED P/N		UNIT WEIGHT(g)	MINIIMUM PACKAGE(pcs)	INNER BOX QUANTITY(pcs)	OUTER CARTON QUANTITY(pcs)	DELIVERY MODE
MUR2040FCT	MUR2060FCT	Approximate 1.49	50	1000	5000	Tube

Characteristics (Typical)

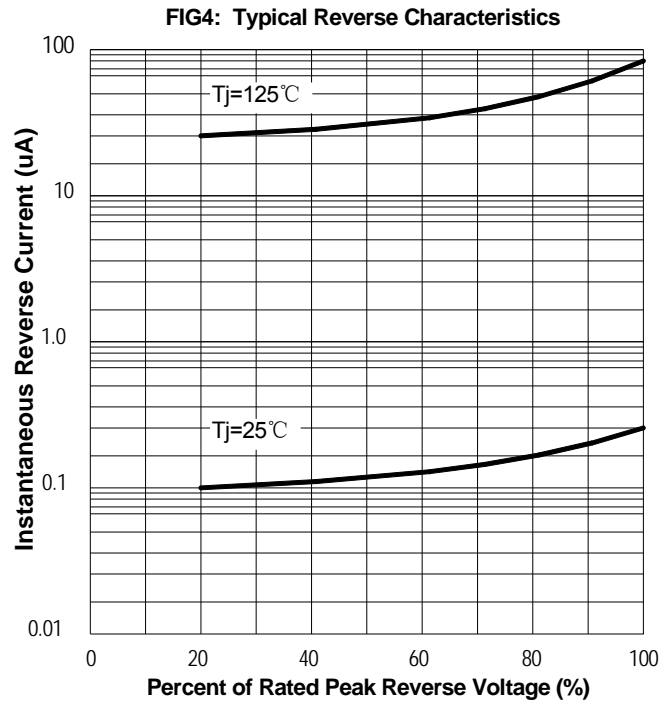
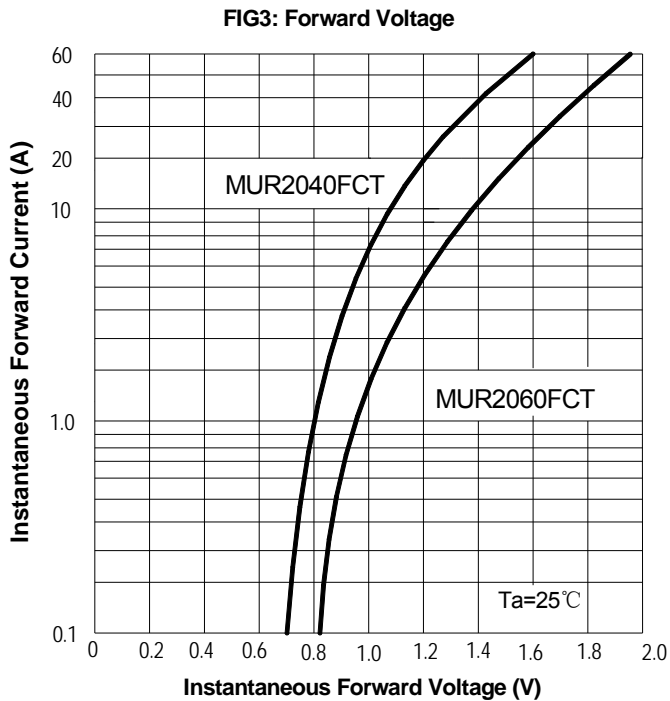
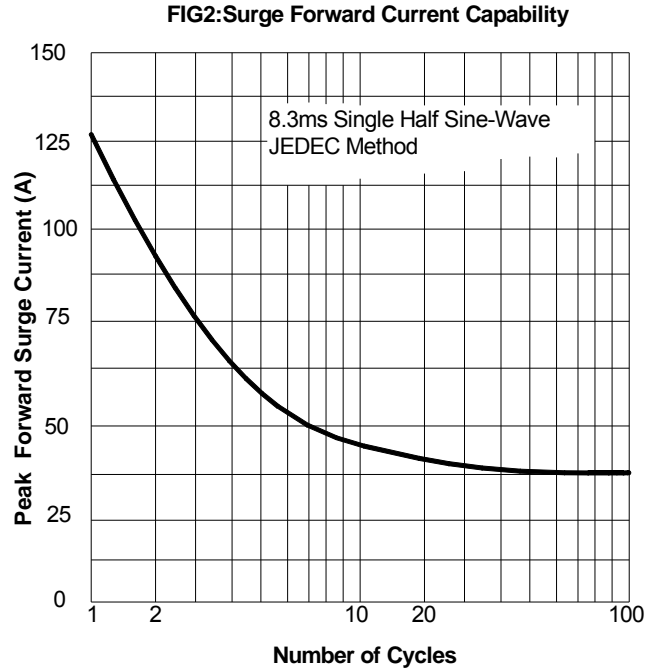
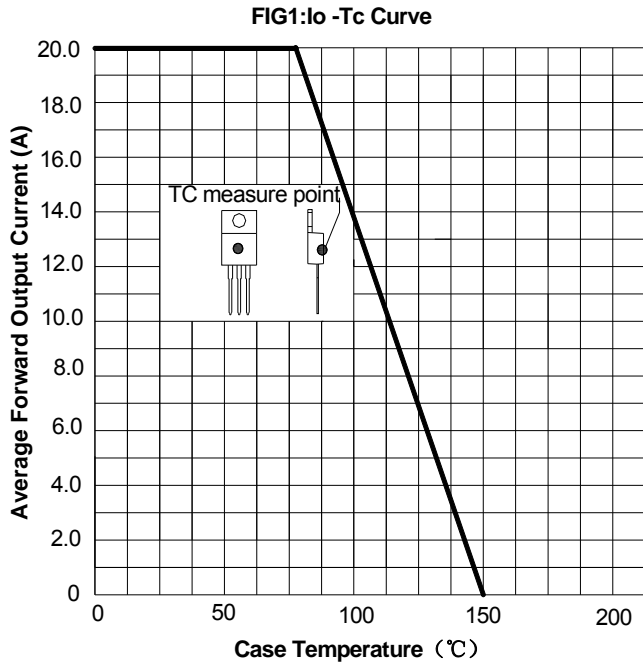



MUR2040FCT THUR MUR2060FCT

FIG.5 Diagram of circuit and Testing wave form of reverse recovery time

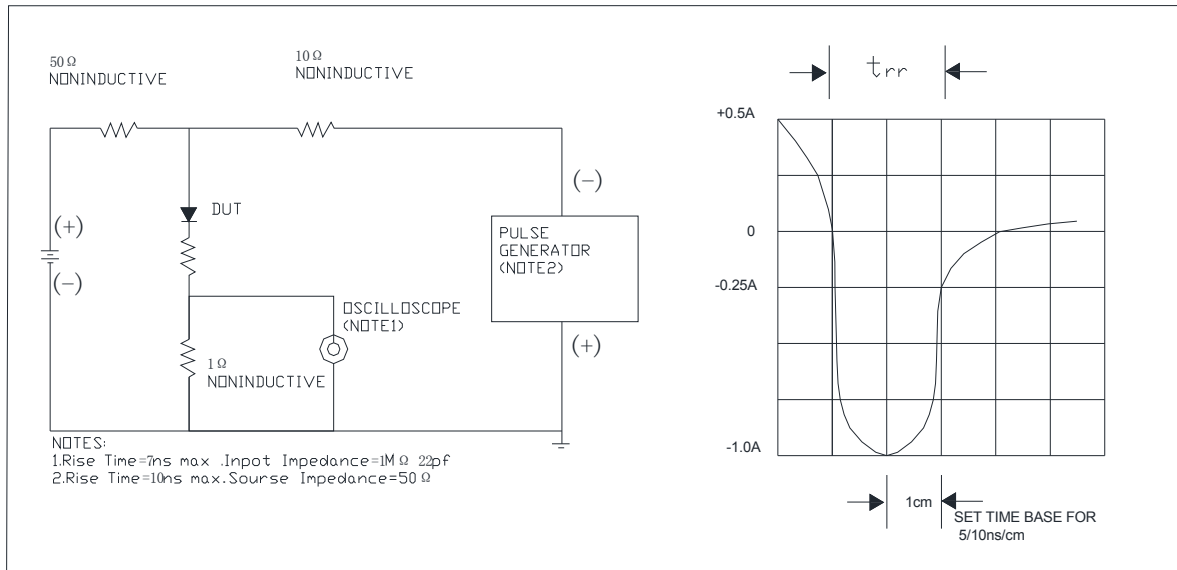

Outline Dimensions

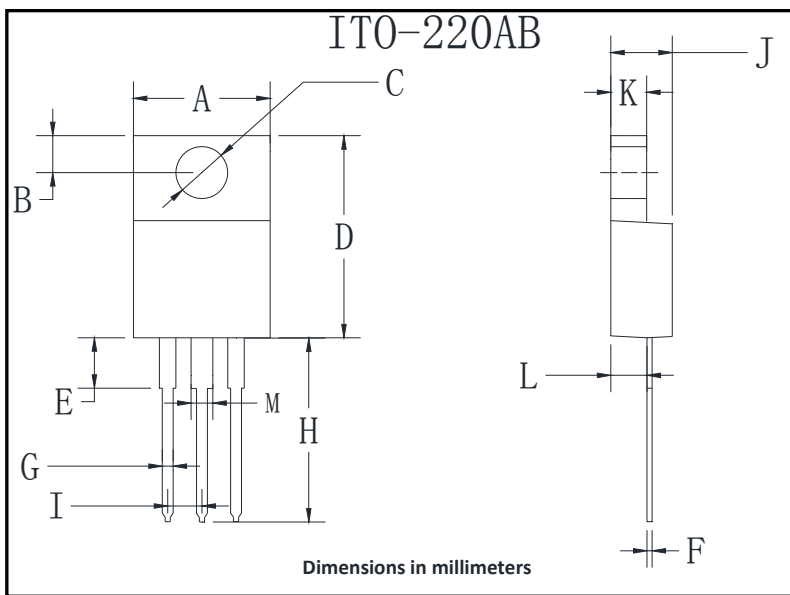

ITO-220AB		
Dim	Min	Max
A	9.7	10.7
B	2.15	3.25
C	2.6	3.8
D	14.4	15.9
E	3.1	4.5
F	0.4	0.8
G	0.4	0.8
H	12.7	14.2
I	1.80	2.95
J	3.9	5.1
K	2.1	3.56
L	2.1	3.2
M	1.4	1.8



Disclaimer

The information presented in this document is for reference only. Yangzhou Yangjie Electronic Technology Co., Ltd. reserves the right to make changes without notice for the specification of the products displayed herein to improve reliability, function or design or otherwise.

The product listed herein is designed to be used with ordinary electronic equipment or devices, and not designed to be used with equipment or devices which require high level of reliability and the malfunction of which would directly endanger human life (such as medical instruments, transportation equipment, aerospace machinery, nuclear-reactor controllers, fuel controllers and other safety devices), Yangjie or anyone on its behalf, assumes no responsibility or liability for any damages resulting from such improper use of sale.

This publication supersedes & replaces all information previously supplied. For additional information, please visit our website [http:// www.21yangjie.com](http://www.21yangjie.com) , or consult your nearest Yangjie's sales office for further assistance.

X-ON Electronics

Largest Supplier of Electrical and Electronic Components

Click to view similar products for [Rectifiers](#) category:

Click to view products by [Yangjie](#) manufacturer:

Other Similar products are found below :

[70HFR40](#) [FR105 R0](#) [RL252-TP](#) [1N5397](#) [1N4005-TR](#) [1N4007-BP](#) [UFS120Je3/TR13](#) [20ETS12S](#) [RRE02VS6SGTR](#) [MS306](#) [A1N5404G-G](#)
[CRF02\(T5L,TEMQ\)](#) [ACGRB207-HF](#) [CLH07\(TE16L,Q\)](#) [CLH03\(TE16L,Q\)](#) [1N5395-TP](#) [UES1302](#) [ACGRC307-HF](#) [ACEFC304-HF](#) [DZ-](#)
[1380](#) [85HFR60](#) [40HFR60](#) [70HF120](#) [85HFR80](#) [SCF7500](#) [SM100](#) [ACGRA4001-HF](#) [SKN70/08](#) [NTE5819](#) [NTE5827](#) [NTE5828](#) [NTE5911](#)
[NTE5915](#) [NTE6104](#) [NTE6163](#) [NTE6164](#) [NTE6165](#) [NTE6364](#) [TSD3G](#) [SET130312](#) [NRVUS110VT3G](#) [UES1106](#) [UES1306](#)
[NRVUS240VT3G](#) [D5FE60-5063](#) [R4000GPS-TP](#) [D4015L56TP](#) [UES1306HR2](#) [FX20K120](#) [D20XB60-7101](#)