

Surface Mount Schottky Rectifier

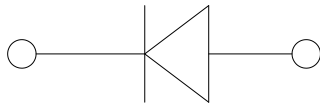
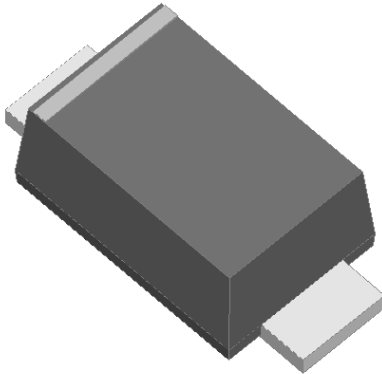

Features

- Low profile package
- Ideal for automated placement
- Guardring for overvoltage protection
- Low power losses, high efficiency
- High forward surge capability
- Meets MSL level 1, per J-STD-020, LF maximum peak of 260 °C

Typical Applications

For use in low voltage high frequency inverters, freewheeling, DC/DC converters, and polarity protection applications.

Mechanical Data

- **Package:** SOD-123FL
Molding compound meets UL 94 V-0 flammability rating, RoHS-compliant, halogen-free
- **Terminals:** Tin plated leads, solderable per J-STD-002 and JESD22-B102
- **Polarity:** Cathode line denotes the cathode end

■ Maximum Ratings ($T_a=25^\circ\text{C}$ Unless otherwise specified)

PARAMETER	SYMBOL	UNIT	S12	S13	S14	S15	S16	S18	S110	S115	S120
Device marking code			S12	S13	S14	S15	S16	S18	S110	S115	S120
Repetitive peak reverse voltage	VRRM	V	20	30	40	50	60	80	100	150	200
Average rectified output current @60Hz sine wave, Resistance load, T_a (FIG.1)	I_O	A	1.0								
Surge(non-repetitive)forward current @60Hz half-sine wave,1 cycle, $T_j=25^\circ\text{C}$	I_{FSM}	A	30								
Storage temperature	T_{stg}	$^\circ\text{C}$	-55 ~+150								
Junction temperature	T_j	$^\circ\text{C}$	-55 ~+125				-55 ~+150				

■ Electrical Characteristics ($T_a=25^\circ\text{C}$ Unless otherwise specified)

PARAMETER	SYMBOL	UNIT	TEST CONDITIONS	S12	S13	S14	S15	S16	S18	S110	S115	S120
Maximum instantaneous forward voltage drop per diode	V_F	V	$I_{FM}=1.0A$	0.50			0.70		0.85		0.90	
Maximum DC reverse current at rated DC blocking voltage per diode @ $V_{RM}=V_{RRM}$	I_{RRM}	mA	$T_a=25^\circ\text{C}$	0.50					0.10			
			$T_a=100^\circ\text{C}$	10					5			



S12 THRU S120

■ Thermal Characteristics ($T_a=25^\circ\text{C}$ Unless otherwise specified)

PARAMETER	SYMBOL	UNIT	S12	S13	S14	S15	S16	S18	S110	S115	S120
Thermal Resistance	R θ J-A	$^\circ\text{C/W}$	70 ¹⁾								
	R θ J-L		20 ¹⁾								

Note:
 (1) Thermal resistance between junction and ambient and between junction and lead mounted on P.C.B with 3mm*3mm copper pad areas.

■ Characteristics (Typical)

FIG1: I_o-T_L Curve

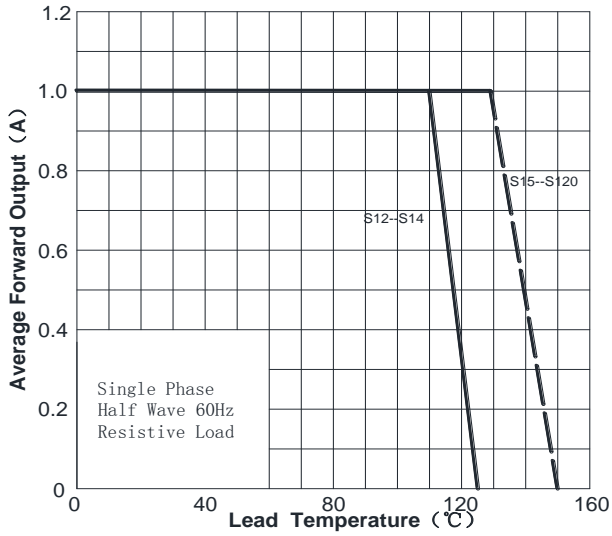

FIG2: Surge Forward Current Capability

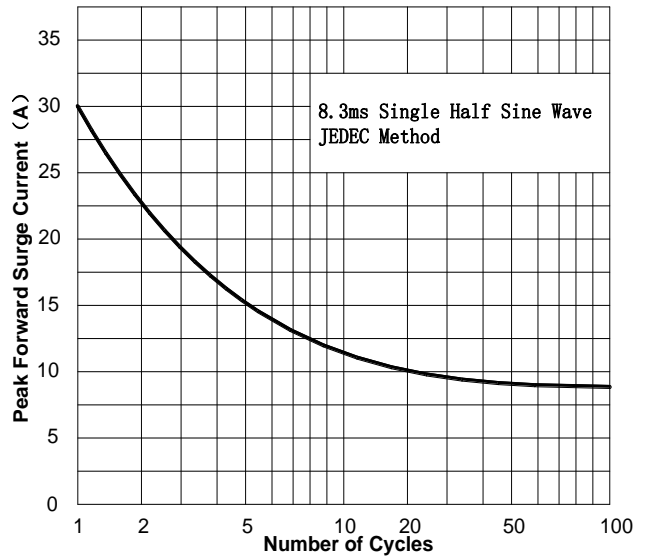

FIG3: Forward Voltage

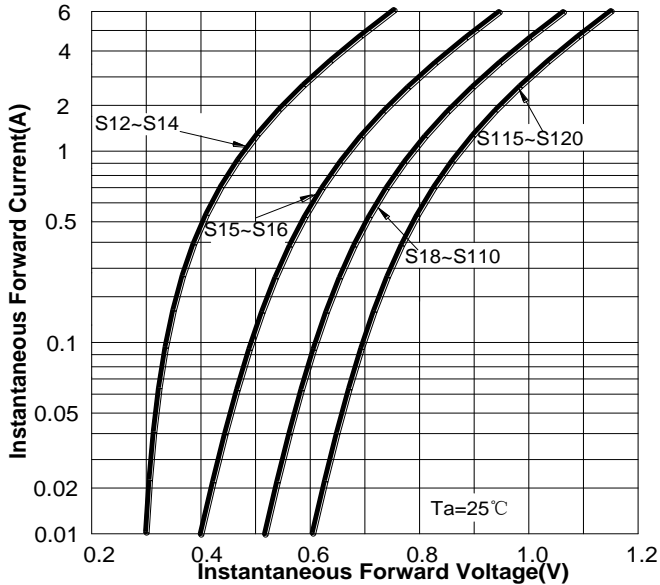
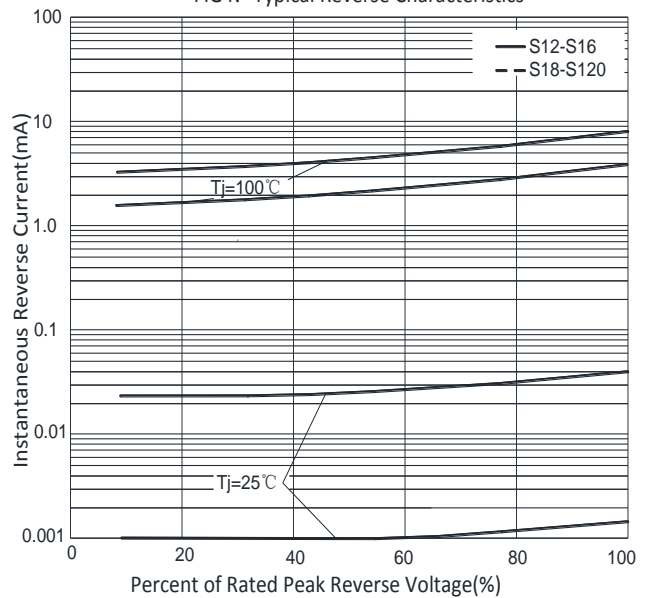

FIG4: Typical Reverse Characteristics





S12 THRU S120

Ordering Information (Example)

PREFERRED P/N	PACKING CODE	UNIT WEIGHT(g)	MINIMUM PACKAGE(pcs)	INNER BOX QUANTITY(pcs)	OUTER CARTON QUANTITY(pcs)	DELIVERY MODE
S12 THRU S120	F1	Approximate 0.0169	3000	15000	120000	7" reel
S12 THRU S120	F2	Approximate 0.0169	2500	12500	100000	7" reel
S12 THRU S120	F3	Approximate 0.0169	10000	30000	210000	13" reel
S12 THRU S120	F4	Approximate 0.0169	3000	27000	108000	7" reel
S12 THRU S120	F5	Approximate 0.0169	10000	20000	160000	13" reel
S12 THRU S120	F6	Approximate 0.0169	3000	12000	60000	7" reel

Outline Dimensions

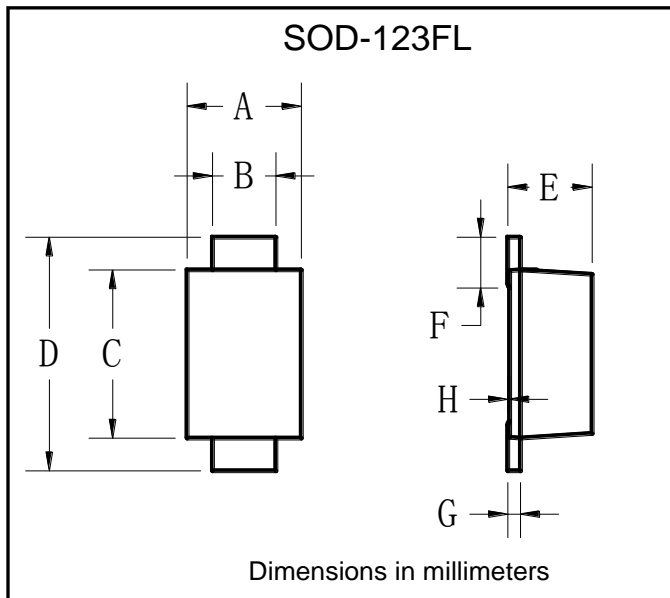

SOD-123FL		
Dim	Min	Max
A	1.60	1.90
B	0.90	1.10
C	2.55	2.85
D	3.60	3.90
E	1.00	1.20
F	0.40	0.90
G	0.10	0.25
H	0.02	0.05

Suggested pad layout

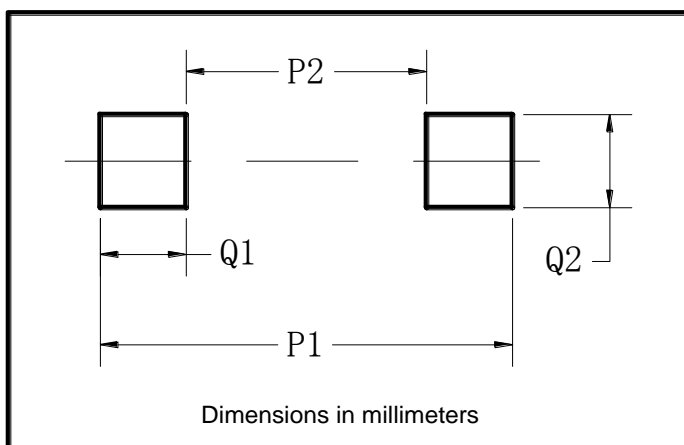

SOD-123FL	
Dim	Millimeters
P1	3.90
P2	1.90
Q1	1.00
Q2	1.50



S12 THRU S120

Disclaimer

The information presented in this document is for reference only. Yangzhou Yangjie Electronic Technology Co., Ltd. reserves the right to make changes without notice for the specification of the products displayed herein to improve reliability, function or design or otherwise.

The product listed herein is designed to be used with ordinary electronic equipment or devices, and not designed to be used with equipment or devices which require high level of reliability and the malfunction of which would directly endanger human life (such as medical instruments, transportation equipment, aerospace machinery, nuclear-reactor controllers, fuel controllers and other safety devices), Yangjie or anyone on its behalf, assumes no responsibility or liability for any damages resulting from such improper use of sale.

This publication supersedes & replaces all information previously supplied. For additional information, please visit our website [http:// www.21yangjie.com](http://www.21yangjie.com) , or consult your nearest Yangjie's sales office for further assistance.

X-ON Electronics

Largest Supplier of Electrical and Electronic Components

Click to view similar products for [Schottky Diodes & Rectifiers](#) category:

Click to view products by [Yangjie](#) manufacturer:

Other Similar products are found below :

[CUS06\(TE85L,Q,M\)](#) [MA4E2039](#) [D1FH3-5063](#) [MBR0530L-TP](#) [MBR10100CT-BP](#) [MBR30H100MFST1G](#) [MMBD301M3T5G](#) [PMAD1103-LF](#) [PMAD1108-LF](#) [RB160M-50TR](#) [RB520S-30](#) [RB551V-30](#) [DD350N18K](#) [DZ435N40K](#) [DZ600N16K](#) [BAS16E6433HTMA1](#) [BAS 3010S-02LRH E6327](#) [BAT 54-02LRH E6327](#) [IDL02G65C5XUMA1](#) [NSR05F40QNXT5G](#) [NSVR05F40NXT5G](#) [JANS1N6640](#) [SB07-03C-TB-H](#) [SB1003M3-TL-W](#) [SBAT54CWT1G](#) [SBM30-03-TR-E](#) [SBS818-TL-E](#) [SK32A-LTP](#) [SK33A-TP](#) [SK34A-TP](#) [SK34B-TP](#) [SMD1200PL-TP](#) [ACDBN160-HF](#) [SS3003CH-TL-E](#) [STPS30S45CW](#) [PDS3100Q-7](#) [GA01SHT18](#) [CRS10I30A\(TE85L,QM\)](#) [MBR1240MFST1G](#) [MBRB30H30CT-1G](#) [BAS28E6433HTMA1](#) [BAS 70-02L E6327](#) [HSB123JTR-E](#) [JANTX1N5712-1](#) [VS-STPS40L45CW-N3](#) [DD350N12K](#) [SB007-03C-TB-E](#) [SB10015M-TL-E](#) [SB1003M3-TL-E](#) [SK110-LTP](#)