

## Surface Mount Transient Voltage Suppressor Diodes

### Uni-directional

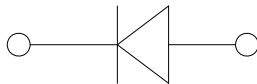
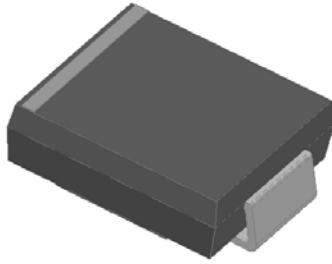

### Features

- Low profile package
- Ideal for automated placement
- Available in Uni-directional and Bi-directional
- 1500W peak pulse power capability with a 10/1000  $\mu$ s waveform
- Excellent clamping capability
- Very fast response time
- Low incremental surge resistance
- Meets MSL level 1, per J-STD-020C, LF maximum peak of 260 °C
- ESD protection of data lines in accordance with IEC 61000-4-2, 30kV(Air),30kV (Contact)
- Part no. with suffix "Q" means AEC-Q101 qualified

### Bi-directional

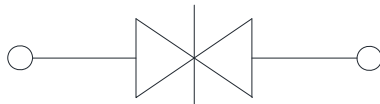
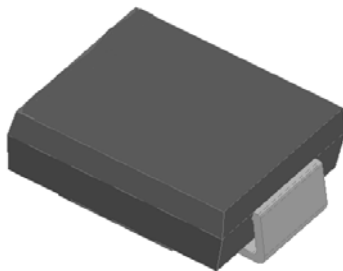

### Typical Applications

Use in sensitive electronics protection against voltage transients induced by inductive load switching and lighting on ICs, MOSFET, signal lines of sensor units for consumer, computer, industrial, automotive, telecommunication.

### Mechanical Data

- **Package:** DO-214AB (SMC)  
Molding compound meets UL 94 V-0 flammability rating, RoHS-compliant, halogen-free
- **Terminals:** Matte tin plated leads, solderable per J-STD-002 and JESD22-B102
- **Polarity:** For uni-directional types the band denotes cathode end, no marking on bi-directional types

### ■Maximum Ratings ( $T_a=25^\circ\text{C}$ Unless otherwise specified)

PARAMETER	SYMBOL	UNIT	Max
Peak power dissipation, with a 10/1000us waveform <sup>(1) (2)</sup>	$P_{PPM}$	W	1500
Peak pulse current, with a 10/1000us waveform <sup>(1)</sup>	$I_{PPM}$	A	See Next Table
Power dissipation, on infinite heat sink at $T_L=75^\circ\text{C}$ <sup>(2)</sup>	$P_D$	W	6.5
Peak forward surge current, 8.3 ms single half sine-wave unidirectional only <sup>(3)</sup>	$I_{FSM}$	A	200
Operating junction	$T_J$	$^\circ\text{C}$	-55 to +175
Storage temperature range	$T_{STG}$	$^\circ\text{C}$	-55 to +175

### ■Electrical Characteristics ( $T_a=25^\circ\text{C}$ Unless otherwise specified)

PARAMETER	SYMBOL	UNIT	VALUE
Maximum instantaneous forward voltage at 100A for unidirectional only <sup>(4)</sup>	$V_{FM}$	V	3.5



# SMCJ5.0AQ THRU SMCJ190CAQ

## ■Electrical Characteristics (Ta=25°C Unless otherwise specified)

Part Number (Uni)	Part Number (Bi)	Breakdown Voltage $V_{BR}@I_T$			Maximum Reverse Leakage $I_R^{(6)}$ @ $V_{RWM}$ ( $\mu A$ )	Working Peak Reverse Voltage $V_{RWM}$ (V)	Maximum Reverse Surge Current $I_{PP}^{(7)}$ (A)	Maximum Clamping Voltage $V_c$ @ $I_{PP}$ (V)
		Min(V)	Max (V)	$I_T^{(5)}$ (mA)				
SMCJ5.0AQ	SMCJ5.0CAQ <sup>(8)</sup>	6.4	7.07	10	1000	5	163.0	9.2
SMCJ6.0AQ	SMCJ6.0CAQ	6.67	7.37	10	1000	6	145.6	10.3
SMCJ6.5AQ	SMCJ6.5CAQ	7.22	7.98	10	500	6.5	133.9	11.2
SMCJ7.0AQ	SMCJ7.0CAQ	7.78	8.6	10	200	7	125.0	12
SMCJ7.5AQ	SMCJ7.5CAQ	8.33	9.21	1	100	7.5	116.3	12.9
SMCJ8.0AQ	SMCJ8.0CAQ	8.89	9.83	1	50	8	110.3	13.6
SMCJ8.5AQ	SMCJ8.5CAQ	9.44	10.4	1	20	8.5	104.2	14.4
SMCJ9.0AQ	SMCJ9.0CAQ	10	11.1	1	10	9	97.4	15.4
SMCJ10AQ	SMCJ10CAQ	11.1	12.3	1	5	10	88.24	17
SMCJ11AQ	SMCJ11CAQ	12.20	13.50	1	5	11.0	82.4	18.2
SMCJ12AQ	SMCJ12CAQ	13.30	14.70	1	5	12.0	75.4	19.9
SMCJ13AQ	SMCJ13CAQ	14.40	15.90	1	1	13.0	69.8	21.5
SMCJ14AQ	SMCJ14CAQ	15.60	17.20	1	1	14.0	64.7	23.2
SMCJ15AQ	SMCJ15CAQ	16.70	18.50	1	1	15.0	61.5	24.4
SMCJ16AQ	SMCJ16CAQ	17.80	19.70	1	1	16.0	57.7	26.0
SMCJ17AQ	SMCJ17CAQ	18.90	20.90	1	1	17.0	54.4	27.6
SMCJ18AQ	SMCJ18CAQ	20.00	22.10	1	1	18.0	51.4	29.2
SMCJ19AQ	SMCJ19CAQ	21.10	23.30	1	1	19.0	48.7	30.8
SMCJ20AQ	SMCJ20CAQ	22.20	24.50	1	1	20.0	46.3	32.4
SMCJ22AQ	SMCJ22CAQ	24.40	26.90	1	1	22.0	42.3	35.5
SMCJ24AQ	SMCJ24CAQ	26.70	29.50	1	1	24.0	38.6	38.9
SMCJ26AQ	SMCJ26CAQ	28.90	31.90	1	1	26.0	35.6	42.1
SMCJ28AQ	SMCJ28CAQ	31.10	34.40	1	1	28.0	33.0	45.4
SMCJ30AQ	SMCJ30CAQ	33.30	36.80	1	1	30.0	31.0	48.4
SMCJ33AQ	SMCJ33CAQ	36.70	40.60	1	1	33.0	28.1	53.3
SMCJ36AQ	SMCJ36CAQ	40.00	44.20	1	1	36.0	25.8	58.1
SMCJ40AQ	SMCJ40CAQ	44.40	49.10	1	1	40.0	23.3	64.5



# SMCJ5.0AQ THRU SMCJ190CAQ

SMCJ43AQ	SMCJ43CAQ	47.80	52.80	1	1	43.0	21.6	69.4
SMCJ45AQ	SMCJ45CAQ	50.00	55.30	1	1	45.0	20.6	72.7
SMCJ48AQ	SMCJ48CAQ	53.30	58.90	1	1	48.0	19.4	77.4
SMCJ51AQ	SMCJ51CAQ	56.7	62.7	1	1	51	18.2	82.4
SMCJ54AQ	SMCJ54CAQ	60	66.3	1	1	54	17.2	87.1
SMCJ58AQ	SMCJ58CAQ	64.4	71.2	1	1	58	16.0	93.6
SMCJ60AQ	SMCJ60CAQ	66.7	73.7	1	1	60	15.5	96.8
SMCJ64AQ	SMCJ64CAQ	71.1	78.6	1	1	64	14.6	103
SMCJ70AQ	SMCJ70CAQ	77.8	86	1	1	70	13.3	113
SMCJ75AQ	SMCJ75CAQ	83.3	92.1	1	1	75	12.4	121
SMCJ78AQ	SMCJ78CAQ	86.7	95.8	1	1	78	11.9	126
SMCJ80AQ	SMCJ80CAQ	88.8	97.6	1	1	80	11.6	129.6
SMCJ85AQ	SMCJ85CAQ	94.4	104	1	1	85	10.9	137
SMCJ90AQ	SMCJ90CAQ	100	111	1	1	90	10.3	146
SMCJ100AQ	SMCJ100CAQ	111	123	1	1	100	9.3	162
SMCJ110AQ	SMCJ110CAQ	122	135	1	1	110	8.5	177
SMCJ120AQ	SMCJ120CAQ	133	147	1	1	120	7.8	193
SMCJ130AQ	SMCJ130CAQ	144	159	1	1	130	7.2	209
SMCJ140AQ	SMCJ140CAQ	155	171	1	1	140	6.6	226.8
SMCJ150AQ	SMCJ150CAQ	167	185	1	1	150	6.2	243
SMCJ160AQ	SMCJ160CAQ	178	197	1	1	160	5.8	259
SMCJ170AQ	SMCJ170CAQ	189	209	1	1	170	5.5	275
SMCJ180AQ	SMCJ180CAQ	200	220	1	1	180	5.1	291.6
SMCJ190AQ	SMCJ190CAQ	211	232	1	1	190	4.9	307.8

## ■ Thermal Characteristics (Ta=25°C Unless otherwise specified)

PARAMETER	SYMBOL	UNIT	Conditions	VALUE
Thermal Resistance(Typical)	$R_{\theta J-A}^{(9)}$	°C/W	junction to ambient	75
	$R_{\theta J-L}$	°C/W	junction to lead	15

Notes:

- (1) Non-repetitive current pulse, per Fig.3 and derated above  $T_J = 50^\circ\text{C}$  per Fig.2.
- (2) Mounted on 0.31 x 0.31" (8.0 x 8.0 mm) copper pads to each terminal
- (3) Measured on 8.3ms single half sine-wave or equivalent square wave,duty cycle=4 pulses per minute maximum.
- (4)  $V_F=3.5\text{V}$  Max for devices of  $V_{BR}\leq 220\text{V}$ .
- (5) Pulse Test:  $t_p\leq 50\text{ms}$ .



# SMCJ5.0AQ THRU SMCJ190CAQ

- (6) For bi-directional types having  $V_{RWM}$  of 10 V and less, the IR limit is doubled.
- (7) Surge current waveform per Fig.3 and derated per Fig.2.
- (8) For the bi-directional SMCJ5.0CAQ, the maximum  $V_{BR}$  is 7.25 V.
- (9) Mounted on minimum recommended pad layout.

## Ordering Information (Example)

PREFERRED P/N	PACKAGE CODE	UNIT WEIGHT(g)	MINIMUM PACKAGE(pcs)	OUTER CARTON QUANTITY(pcs)	DELIVERY MODE
SMCJ SERIES	F1	Approximate 0.257	3000	42000	13" reel

## Marking Information

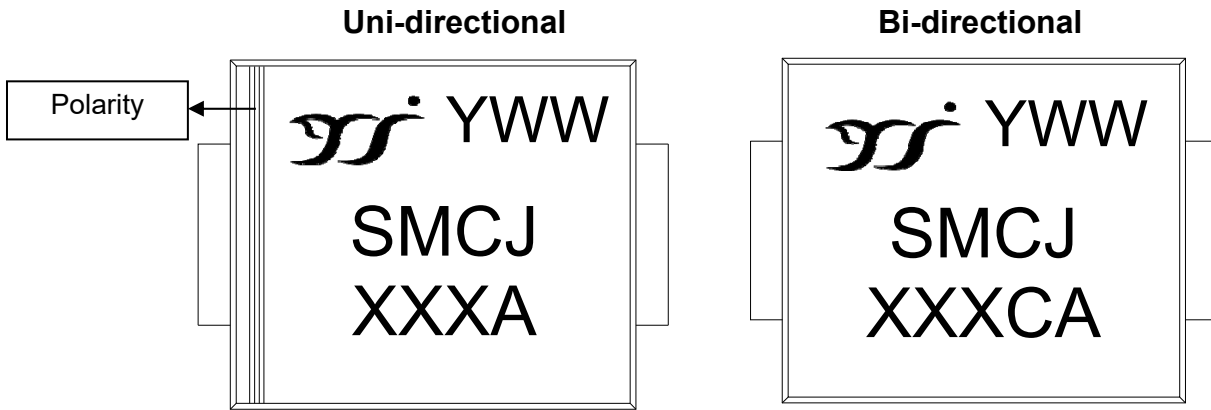

**Note:**

1. All marking is at middle of the product body
2. All marking is in laser printing
3. XXX is marking code, like 190A/190C marking code is 190
4. Body color: Black
5. YWW is date code, "Y" is year. "WW" is week.

For instance:  
 The 17<sup>th</sup> week of 2021, date code is 117  
 The 17<sup>th</sup> week of 2022, date code is 217

## Characteristics(Typical)

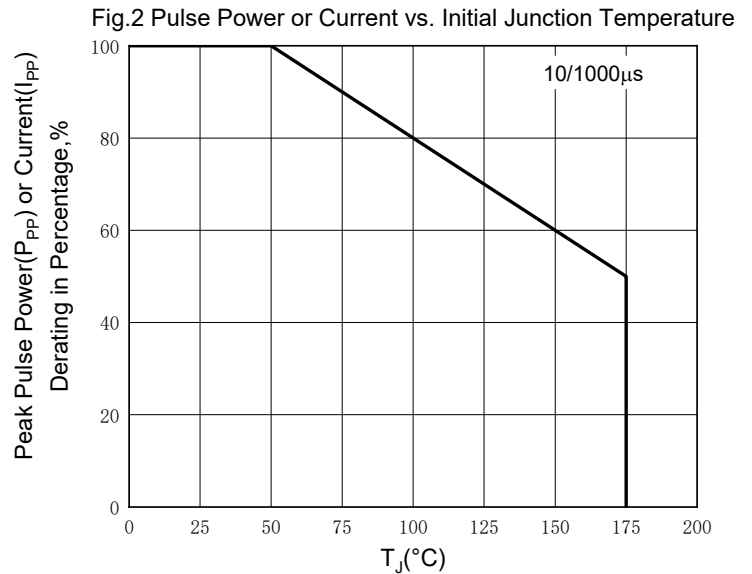
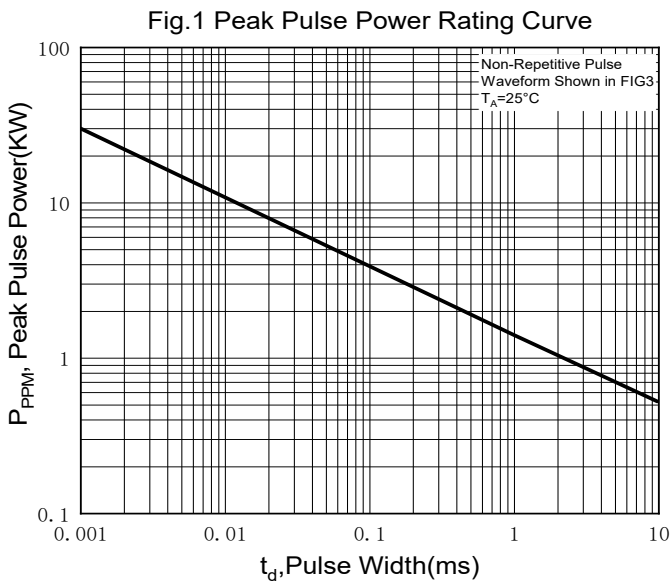



# SMCJ5.0AQ THRU SMCJ190CAQ

Fig.3 Pulse Waveform

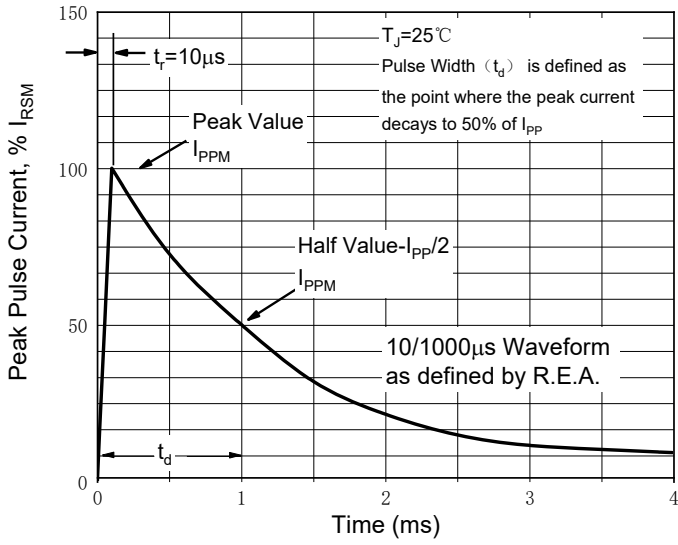

Fig.4 Typical Transient Thermal Impedance

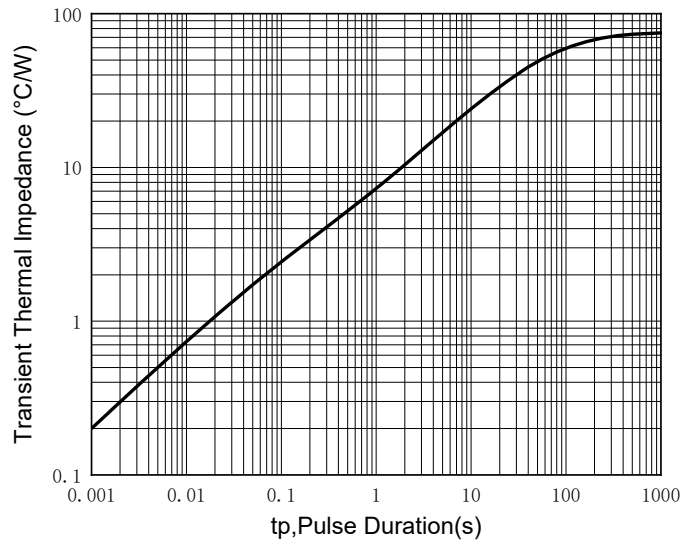

Fig.5 Maximum Non-Repetitive Forward Surge Current

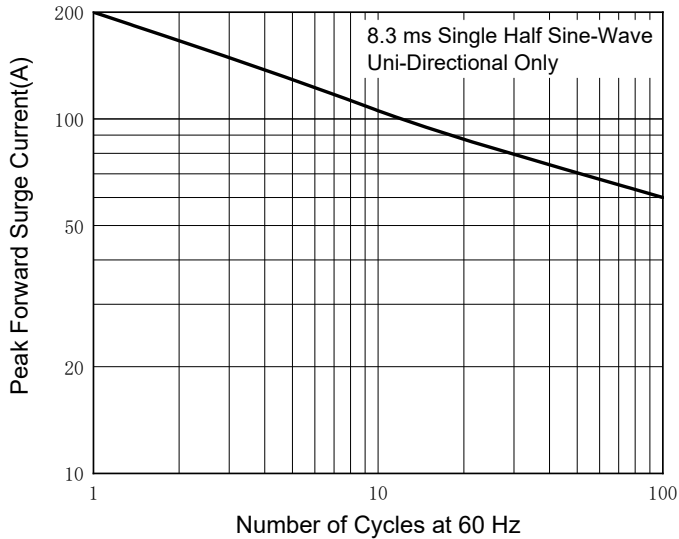
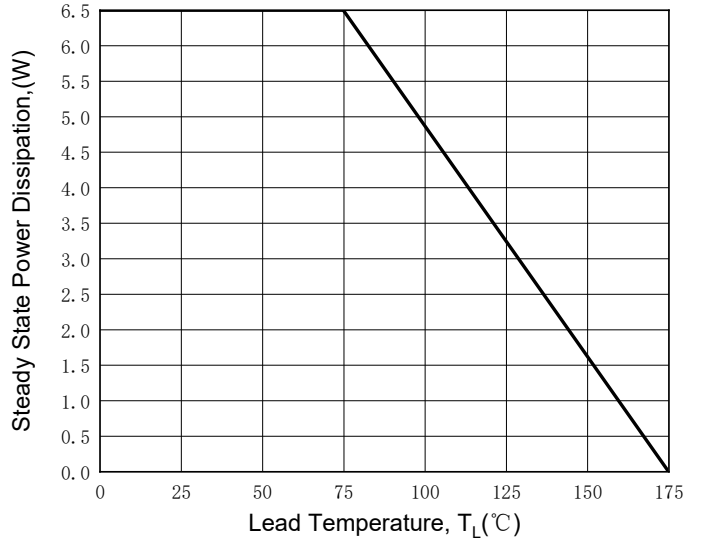
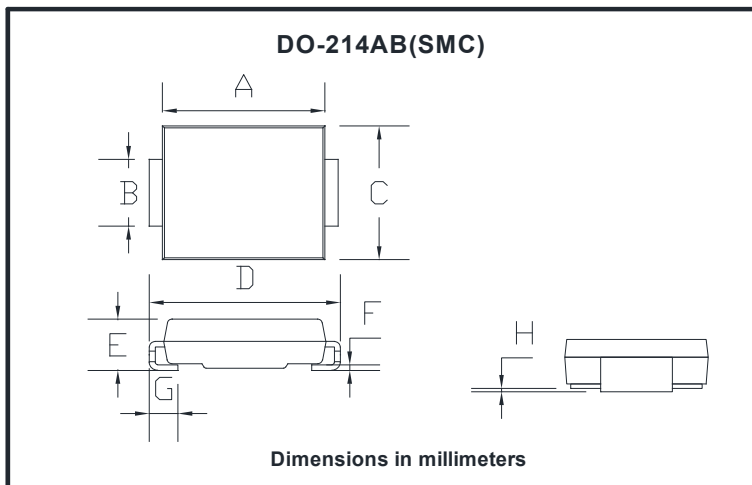

Fig.6 Steady State Power Derating Curve



## ■ Outline Dimensions



DO-214AB (SMC)		
Dim	Min	Max
A	6.60	7.11
B	2.85	3.27
C	5.59	6.22
D	7.75	8.13
E	1.99	2.61
F	0.15	0.31
G	0.76	1.52
H	0.05	0.20



## SMCJ5.0AQ THRU SMCJ190CAQ

### ■ Suggested pad layout

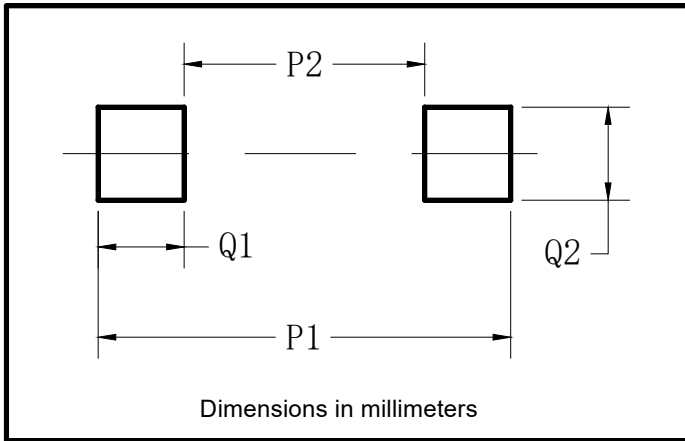

Dim	Typ
P1	9.9
P2	3.84
Q1	3.03
Q2	3.82



## SMCJ5.0AQ THRU SMCJ190CAQ

---

### Disclaimer

The information presented in this document is for reference only. Yangzhou Yangjie Electronic Technology Co., Ltd. reserves the right to make changes without notice for the specification of the products displayed herein to improve reliability, function or design or otherwise.

The product listed herein is designed to be used with automotive electronics, are not designed for use in medical, lifesaving, lifesustaining, or military, Yangjie or anyone on its behalf, assumes no responsibility or liability for any damages resulting from such improper use of sale.

This publication supersedes & replaces all information previously supplied. For additional information, please visit our website [http:// www.21yangjie.com](http://www.21yangjie.com) , or consult your nearest Yangjie's sales office for further assistance.

## X-ON Electronics

Largest Supplier of Electrical and Electronic Components

*Click to view similar products for [ESD Suppressors / TVS Diodes](#) category:*

*Click to view products by [Yangjie](#) manufacturer:*

Other Similar products are found below :

[60KS200C](#) [D18V0L1B2LP-7B](#) [D5V0F4U5P5-7](#) [NTE4902](#) [P4KE27CA](#) [P6KE11CA](#) [P6KE8.2A](#) [SA60CA](#) [SA64CA](#) [SMBJ12CATR](#)  
[SMBJ33CATR](#) [SMBJ6.5A](#) [SMBJ8.0A](#) [ESD101-B1-02ELS E6327](#) [ESD112-B1-02EL E6327](#) [ESD7451N2T5G](#) [19180-510](#) [CPDT-5V0USP-](#)  
[HF](#) [3.0SMCJ33CA-F](#) [3.0SMCJ36A-F](#) [HSPC16701B02TP](#) [JANTX1N6126A](#) [D3V3Q1B2DLP3-7](#) [D55V0M1B2WS-7](#) [SCM1293A-04SO](#)  
[ESD200-B1-CSP0201 E6327](#) [SM12-7](#) [CEN955 W/DATA](#) [VESD12A1A-HD1-GS08](#) [CPDQC5V0-HF](#) [D1213A-01LP4-7B](#) [ESD101-B1-02EL](#)  
[E6327](#) [AOZ8808DI-03](#) [5KP15A](#) [5KP48A](#) [5KP90A](#) [ESD3V3D7-TP](#) [15KPA36A-LF](#) [P4KE56CA](#) [P4KE68A](#) [P4KE91CATR](#) [P6KE120A](#)  
[P6KE13CA](#) [P6KE43CA](#) [P6KE6.8CA](#) [P6KE8.2](#) [P6SMBJ20CA](#) [JANTX1N6072A](#) [SR2835ESKG](#) [SA90CA](#)