

N-Channel Enhancement Mode Field Effect Transistor

PDFN 5X6

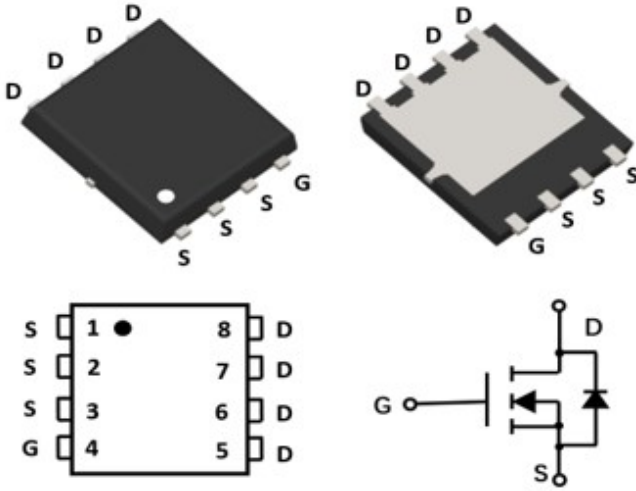

Product Summary

- V_{DS} 30V
- I_D 40A
- $R_{DS(ON)}$ (at $V_{GS}=10V$) <7.5mohm
- $R_{DS(ON)}$ (at $V_{GS}=4.5V$) <11.5mohm
- 100% UIS Tested
- 100% ∇V_{DS} Tested

General Description

- Trench Power LV MOSFET technology
- Excellent package for heat dissipation
- High density cell design for low $R_{DS(ON)}$

Applications

- High current load applications
- Load switching
- Hard switched and high frequency circuits
- Uninterruptible power supply

■ Absolute Maximum Ratings ($T_A=25^\circ C$ unless otherwise noted)

Parameter		Symbol	Limit	Unit
Drain-source Voltage		V_{DS}	30	V
Gate-source Voltage		V_{GS}	± 20	V
Drain Current	$T_C=25^\circ C$	I_D	40	A
	$T_C=100^\circ C$		25	
Pulsed Drain Current ^A		I_{DM}	140	A
Total Power Dissipation	$T_C=25^\circ C$	P_D	45	W
	$T_C=100^\circ C$		18	
Total Power Dissipation	$T_A=25^\circ C$	P_D	5	W
Single Pulse Avalanche Energy ^B		E_{AS}	56	mJ
Thermal Resistance Junction-to-Case ^C		$R_{\theta JC}$	2.78	$^\circ C/W$
Thermal Resistance Junction-to-Ambient ^C		$R_{\theta JA}$	25	$^\circ C/W$
Junction and Storage Temperature Range		T_J, T_{STG}	-55~+150	$^\circ C$

■ Ordering Information (Example)

PREFERRED P/N	PACKING CODE	Marking	MINIMUM PACKAGE(pcs)	INNER BOX QUANTITY(pcs)	OUTER CARTON QUANTITY(pcs)	DELIVERY MODE
YJG40N03A	F1	YJG40N03A	5000	10000	100000	13" reel



YJG40N03A

■ Electrical Characteristics (T_J=25°C unless otherwise noted)

Parameter	Symbol	Conditions	Min	Typ	Max	Units
Static Parameter						
Drain-Source Breakdown Voltage	BV _{DSS}	V _{GS} = 0V, I _D =250μA	30			V
Zero Gate Voltage Drain Current	I _{DSS}	V _{DS} =30V, V _{GS} =0V			1	μA
Gate-Body Leakage Current	I _{GSS}	V _{GS} = ±20V, V _{DS} =0V			±100	nA
Gate Threshold Voltage	V _{GS(th)}	V _{DS} = V _{GS} , I _D =250μA	1.0	1.5	2.5	V
Static Drain-Source On-Resistance	R _{DS(ON)}	V _{GS} = 10V, I _D =15A		5.5	7.5	mΩ
		V _{GS} = 4.5V, I _D =15A		9.5	11.5	
Diode Forward Voltage	V _{SD}	I _S =15A, V _{GS} =0V		0.85	1.2	V
Maximum Body-Diode Continuous Current	I _S				40	A
Dynamic Parameters						
Input Capacitance	C _{iss}	V _{DS} =15V, V _{GS} =0V, f=1MHZ		1015		pF
Output Capacitance	C _{oss}			201		
Reverse Transfer Capacitance	C _{rss}			164		
Gate resistance	R _g	f=1MHz		2.0		Ω
Switching Parameters						
Total Gate Charge	Q _g	V _{GS} =10V, V _{DS} =15V, I _D =15A		23.6		nC
Gate-Source Charge	Q _{gs}			3.9		
Gate-Drain Charge	Q _{gd}			7		
Reverse Recovery Charge	Q _{rr}	I _F =25A, di/dt=100A/us		0.2		ns
Reverse Recovery Time	t _{rr}			5		
Turn-on Delay Time	t _{D(on)}	V _{GS} =10V, V _{DD} =20V, I _D =2A, R _L =1Ω R _{GEN} =3Ω		7		ns
Turn-on Rise Time	t _r			19		
Turn-off Delay Time	t _{D(off)}			24		
Turn-off fall Time	t _f			24		

A. Pulse Test: Pulse Width ≤ 300us, Duty cycle ≤ 2%.

B. T_J=25°C, V_{DD}=20V, V_G=10V, L=0.5mH, R_g=25Ω

C. R_{θJA} is the sum of the junction-to-case and case-to-ambient thermal resistance, where the case thermal reference is defined as the solder mounting surface of the drain pins. R_{θJC} is guaranteed by design, while R_{θJA} is determined by the board design. The maximum rating presented here is based on mounting on a 1 in 2 pad of 2oz copper.



■ Typical Performance Characteristics

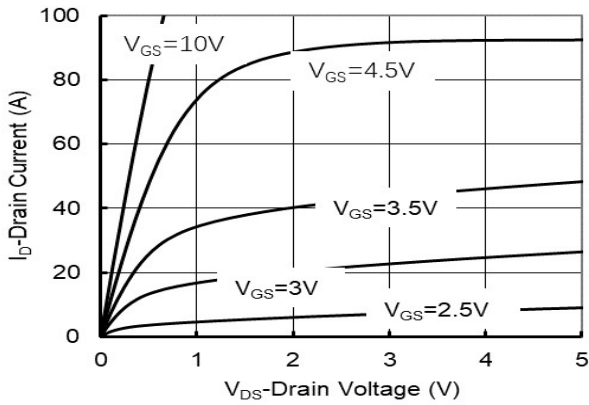

Figure1. Output Characteristics

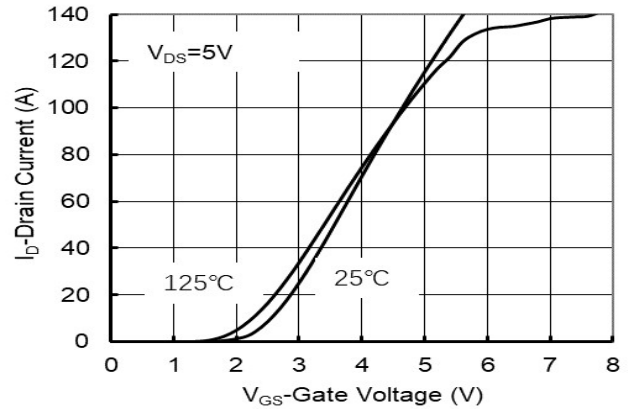

Figure2. Transfer Characteristics

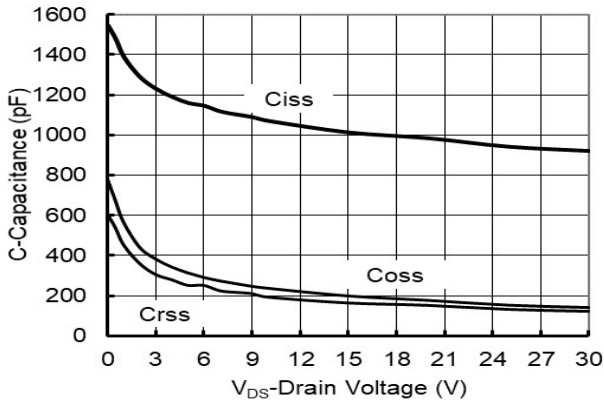

Figure3. Capacitance Characteristics

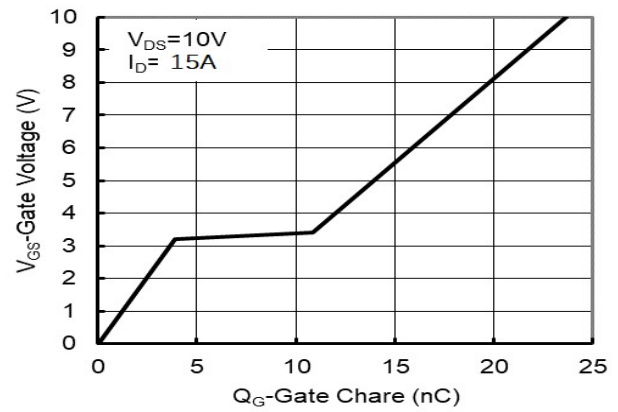

Figure4. Gate Charge

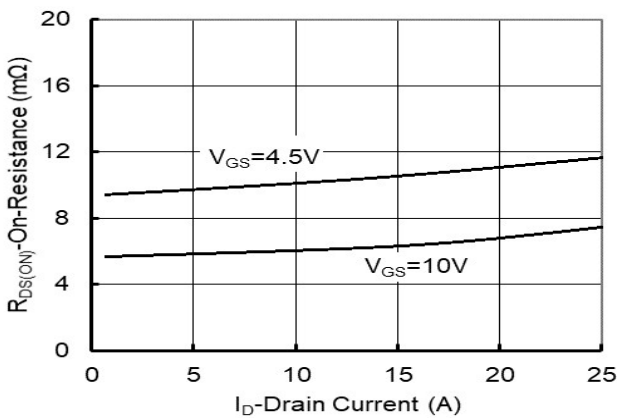

Figure5. Drain-Source on Resistance

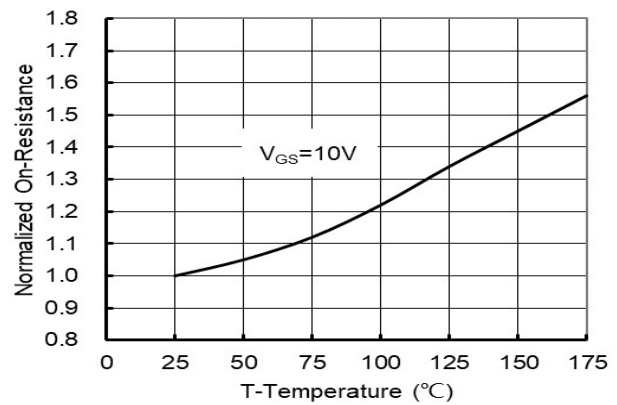

Figure6. Drain-Source on Resistance



YJG40N03A

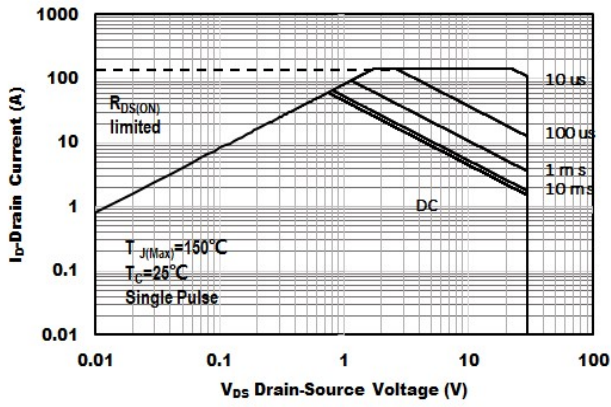

Figure7. Safe Operation Area

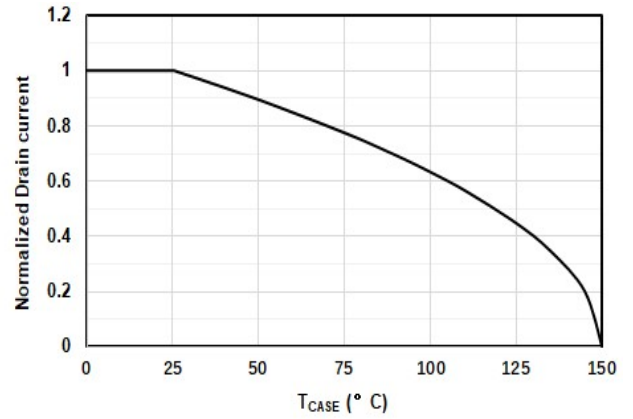

Figure8. Drain current vs. Case Temperature

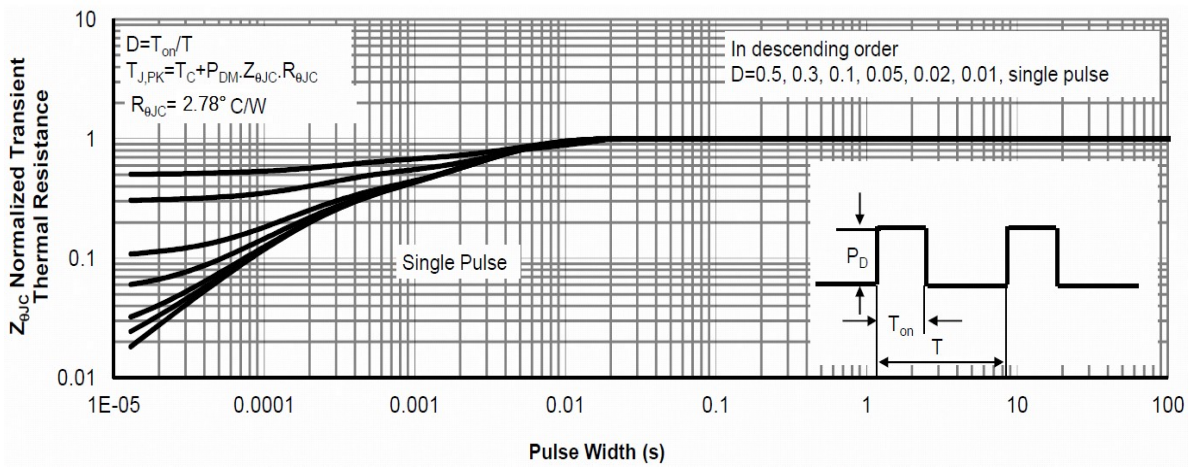
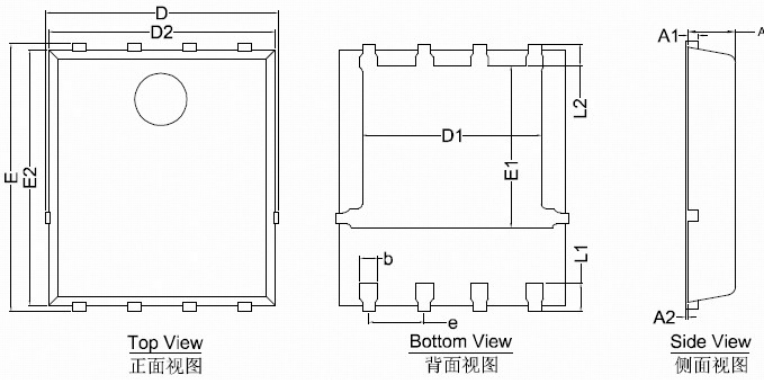

Figure 9. Normalized Maximum Transient Thermal Impedance



YJG40N03A

■ PDFN 5x6 Package Information



SYMBOL	MILLIMETER		
	MIN	NOM	MAX
D	5.15	5.35	5.55
E	5.95	6.15	6.35
A	1.00	1.10	1.20
A1	0.254 BSC		
A2			0.10
D1	3.92	4.12	4.32
E1	3.52	3.72	3.92
D2	5.00	5.20	5.40
E2	5.66	5.86	6.06
L1	0.56	0.66	0.76
L2	0.50 BSC		
b	0.31	0.41	0.51
e	1.27 BSC		

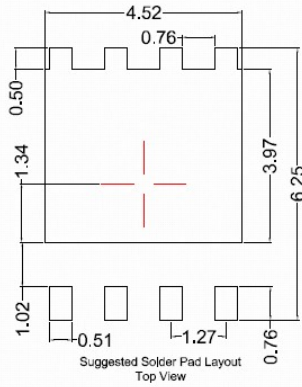

- Note:
1. Controlling dimension: in millimeters.
 2. General tolerance: $\pm 0.10\text{mm}$.
 3. The pad layout is for reference purposes only.



Disclaimer

The information presented in this document is for reference only. Yangzhou Yangjie Electronic Technology Co., Ltd. reserves the right to make changes without notice for the specification of the products displayed herein to improve reliability, function or design or otherwise.

The product listed herein is designed to be used with ordinary electronic equipment or devices, and not designed to be used with equipment or devices which require high level of reliability and the malfunction of which would directly endanger human life (such as medical instruments, transportation equipment, aerospace machinery, nuclear-reactor controllers, fuel controllers and other safety devices), Yangjie or anyone on its behalf, assumes no responsibility or liability for any damages resulting from such improper use of sale.

This publication supersedes & replaces all information previously supplied. For additional information, please visit our website [http:// www.21yangjie.com](http://www.21yangjie.com) , or consult your nearest Yangjie's sales office for further assistance.

X-ON Electronics

Largest Supplier of Electrical and Electronic Components

Click to view similar products for [MOSFET](#) category:

Click to view products by [Yangjie](#) manufacturer:

Other Similar products are found below :

[614233C](#) [648584F](#) [MCH3443-TL-E](#) [MCH6422-TL-E](#) [FDPF9N50NZ](#) [NTNS3A92PZT5G](#) [IRFD120](#) [IRFF430](#) [JANTX2N5237](#) [2N7000](#)
[AOD464](#) [2SK2267\(Q\)](#) [2SK2545\(Q,T\)](#) [405094E](#) [423220D](#) [MIC4420CM-TR](#) [VN1206L](#) [614234A](#) [715780A](#) [SSM6J414TU,LF\(T](#) [751625C](#)
[IPS70R2K0CEAKMA1](#) [BSF024N03LT3 G](#) [PSMN4R2-30MLD](#) [TK31J60W5,S1VQ\(O](#) [2SK2614\(TE16L1,Q\)](#) [DMN1017UCP3-7](#)
[EFC2J004NUZTDG](#) [FCAB21350L1](#) [P85W28HP2F-7071](#) [DMN1053UCP4-7](#) [NTE2384](#) [NTE2969](#) [NTE6400A](#) [DMC2700UDMQ-7](#)
[DMN2080UCB4-7](#) [DMN61D9UWQ-13](#) [US6M2GTR](#) [DMN31D5UDJ-7](#) [SSM6P54TU,LF](#) [DMP22D4UFO-7B](#) [IPS60R3K4CEAKMA1](#)
[DMN1006UCA6-7](#) [DMN16M9UCA6-7](#) [STF5N65M6](#) [IRF40H233XTMA1](#) [IPSA70R950CEAKMA1](#) [IPSA70R2K0CEAKMA1](#) [STU5N65M6](#)
[C3M0021120D](#)