

P-Channel Enhancement Mode Field Effect Transistor

Product Summary

- V_{DS} -20V
- I_D -0.65A
- $R_{DS(ON)}$ (at $V_{GS}=-4.5V$) < 520 mohm
- $R_{DS(ON)}$ (at $V_{GS}=-2.5V$) < 750 mohm
- ESD Protected Up to 4.5KV (HBM)

General Description

- Trench Power LV MOSFET technology
- High Density Cell Design for Low $R_{DS(ON)}$
- High Speed switching

Applications

- Interfacing, Logic switch
- Load switch
- Power management

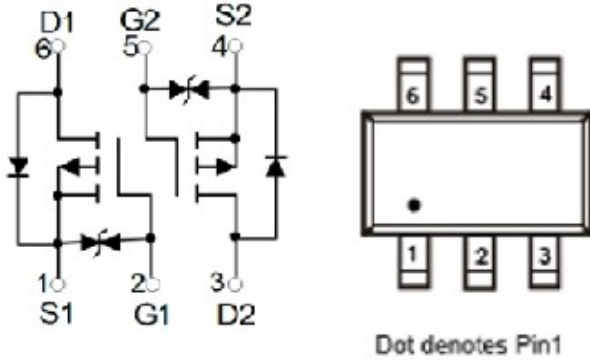

SOT-363

■ Absolute Maximum Ratings ($T_A=25^\circ C$ unless otherwise noted)

Parameter	Symbol	Maximum	Unit
Drain-source Voltage	V_{DS}	-20	V
Gate-source Voltage	V_{GS}	± 12	V
Drain Current	I_D	$T_A=25^\circ C$ Steady State	-0.65
		$T_A=70^\circ C$ Steady State	-0.52
Pulsed Drain Current ^A	I_{DM}	-2.6	A
Total Power Dissipation @ $T_A=25^\circ C$ Steady State	P_D	0.2	W
Thermal Resistance Junction-to-Ambient @ Steady State ^B	$R_{\theta JA}$	625	$^\circ C/W$
Junction and Storage Temperature Range	T_J, T_{STG}	-55~+150	$^\circ C$

■ Ordering Information (Example)

PREFERRED P/N	PACKING CODE	Marking	MINIMUM PACKAGE(pcs)	INNER BOX QUANTITY(pcs)	OUTER CARTON QUANTITY(pcs)	DELIVERY MODE
YJL3139KDW	F2	39K	3000	30000	120000	7" reel

YJL3139KDW

■ Electrical Characteristics (T_J=25°C unless otherwise noted)

Parameter	Symbol	Conditions	Min	Typ	Max	Units
Static Parameter						
Drain-Source Breakdown Voltage	BV _{DSS}	V _{GS} = 0V, I _D =-250μA	-20			V
Zero Gate Voltage Drain Current	I _{DSS}	V _{DS} =-20V, V _{GS} =0V, T _C =25°C			-1	μA
Gate-Body Leakage Current	I _{GSS}	V _{GS} = ±10V, V _{DS} =0V		±1.5	±10	μA
		V _{GS} = ±8V, V _{DS} =0V		±500	±2000	nA
Gate Threshold Voltage	V _{GS(th)}	V _{DS} = V _{GS} , I _D =-250μA	-0.35	-0.61	-1.2	V
Static Drain-Source On-Resistance	R _{DS(ON)}	V _{GS} = -4.5V, I _D =-0.6A		360	520	mΩ
		V _{GS} = -2.5V, I _D =-0.5A		570	750	
		V _{GS} = -1.8V, I _D =-0.3A		860	1300	
Diode Forward Voltage	V _{SD}	I _S =-0.65A, V _{GS} =0V		-0.8	-1.2	V
Maximum Body-Diode Continuous Current	I _S				-0.65	A
Dynamic Parameters						
Input Capacitance	C _{iss}	V _{DS} =-10V, V _{GS} =0V, f=1MHZ		71		pF
Output Capacitance	C _{oss}			20		
Reverse Transfer Capacitance	C _{rss}			15		
Switching Parameters						
Total Gate Charge	Q _g	V _{GS} =-4.5V, V _{DD} =-10V, I _D =-0.65A		1.24		nC
Gate Source Charge	Q _{gs}			0.37		
Gate Drain Charge	Q _{gd}			0.27		
Reverse Recovery Chrage	Q _{rr}	I _F =-0.5A, di/dt=-20A/us		0.97		
Reverse Recovery Time	t _{rr}			26		
Turn-on Delay Time	t _{D(on)}	V _{GS} =-4.5V, V _{DD} =-10V, R _L =2.5Ω, R _{GEN} =3Ω		4		ns
Turn-on Rise Time	t _r			19		
Turn-off Delay Time	t _{D(off)}			16		
Turn-off Fall Time	t _f			25		

A. Pulse Test: Pulse Width ≤ 300us, Duty cycle ≤ 2%.

B. Device mounted on FR-4 PCB, 1 inch x 0.85 inch x 0.062 inch.

■ Typical Performance Characteristics

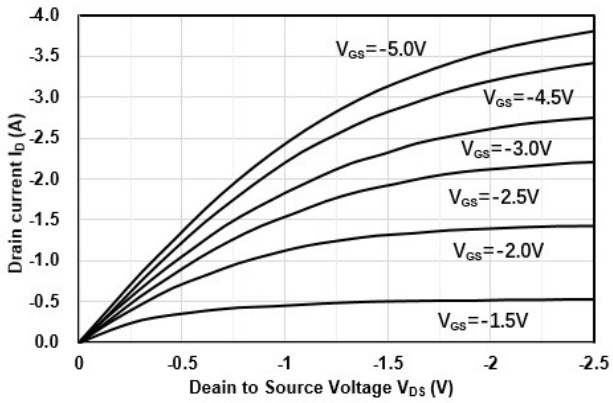

Figure1. Output Characteristics

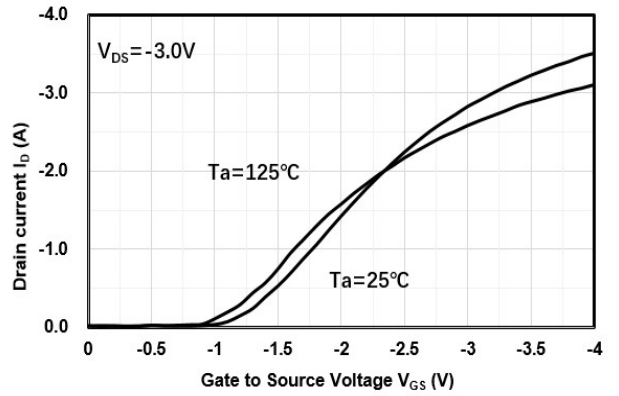

Figure2. Transfer Characteristics

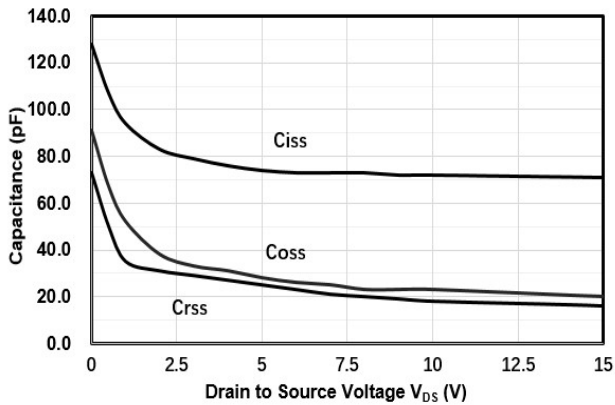

Figure3. Capacitance Characteristics

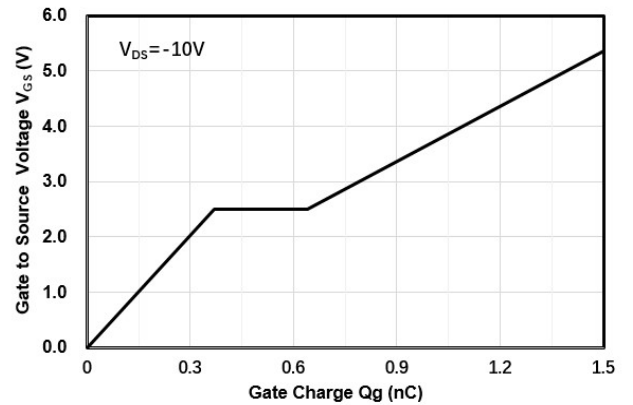

Figure4. Gate Charge

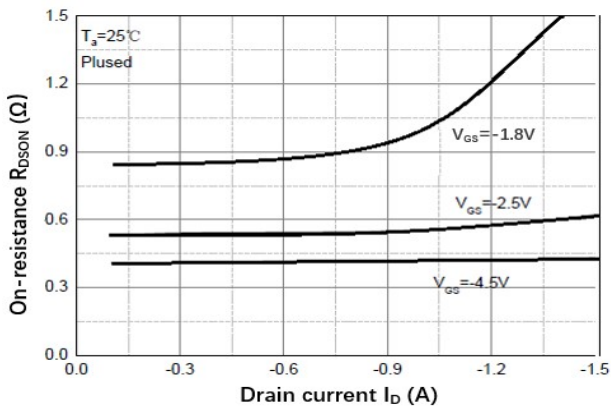

Figure5. Drain-Source on Resistance

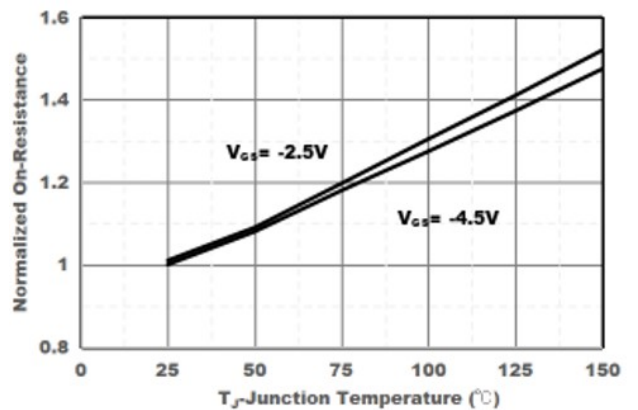

Figure6. Drain-Source on Resistance

YJL3139KDW

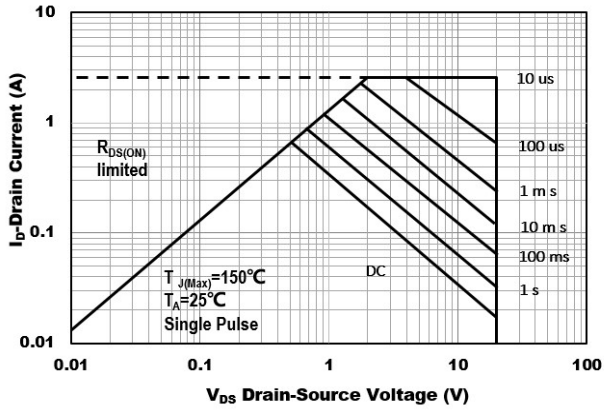

Figure7. Safe Operation Area

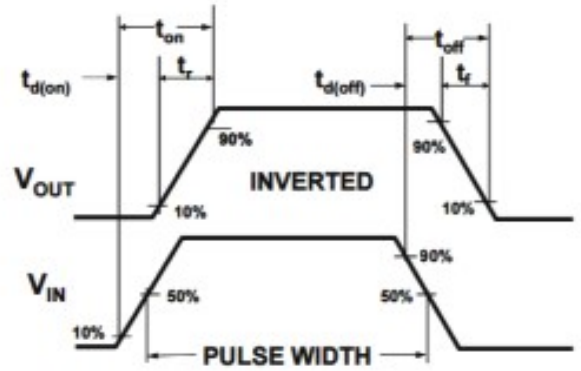
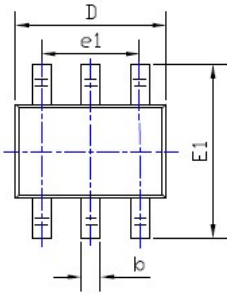

Figure8. Switching wave

YJL3139KDW

■ SOT-363 Package information



TOP VIEW

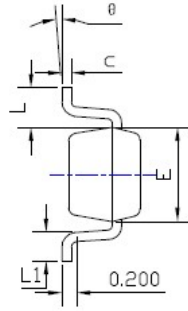

SIDE VIEW

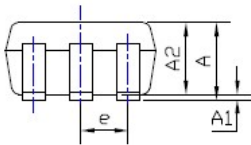

SIDE VIEW

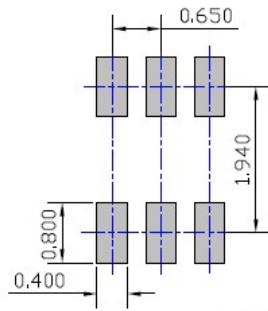

UNIT: mm

SUGGESTED SOLDER PAD LAYOUT

SYMBOL	DIMENSIONS					
	INCHES			Millimeter		
	MIN.	NOM.	MAX.	MIN.	NOM.	MAX.
A	0.035	---	0.043	0.900	---	1.100
A1	0.000	---	0.004	0.000	---	0.100
A2	0.035	0.037	0.039	0.900	0.950	1.000
b	0.006	0.010	0.014	0.150	0.250	0.350
c	0.004	---	0.010	0.100	---	0.250
D	0.071	0.079	0.087	1.800	2.000	2.200
E	0.045	0.049	0.053	1.150	1.250	1.350
E1	0.085	0.091	0.096	2.150	2.300	2.450
e	0.026TYP			0.650TYP		
e1	0.047	0.051	0.055	1.200	1.300	1.400
L	0.021REF			0.525REF		
L1	0.010	0.014	0.018	0.260	0.360	0.460
ø	0*	---	8*	0*	---	8*

NOTE:

1. PACKAGE BODY SIZES EXCLUDE MOLD FLASH AND GATE BURRS.
2. TOLERANCE 0.1mm UNLESS OTHERWISE SPECIFIED.
3. THE PAD LAYOUT IS FOR REFERENCE PURPOSES ONLY.

YJL3139KDW

Disclaimer

The information presented in this document is for reference only. Yangzhou Yangjie Electronic Technology Co., Ltd. reserves the right to make changes without notice for the specification of the products displayed herein to improve reliability, function or design or otherwise.

The product listed herein is designed to be used with ordinary electronic equipment or devices, and not designed to be used with equipment or devices which require high level of reliability and the malfunction of which would directly endanger human life (such as medical instruments, transportation equipment, aerospace machinery, nuclear-reactor controllers, fuel controllers and other safety devices), Yangjie or anyone on its behalf, assumes no responsibility or liability for any damages resulting from such improper use of sale.

This publication supersedes & replaces all information previously supplied. For additional information, please visit our website [http:// www.21yangjie.com](http://www.21yangjie.com) , or consult your nearest Yangjie's sales office for further assistance.

X-ON Electronics

Largest Supplier of Electrical and Electronic Components

Click to view similar products for [MOSFET](#) category:

Click to view products by [Yangjie](#) manufacturer:

Other Similar products are found below :

[614233C](#) [648584F](#) [MCH3443-TL-E](#) [MCH6422-TL-E](#) [FDPF9N50NZ](#) [NTNS3A92PZT5G](#) [IRFD120](#) [IRFF430](#) [JANTX2N5237](#) [2N7000](#)
[AOD464](#) [2SK2267\(Q\)](#) [2SK2545\(Q,T\)](#) [405094E](#) [423220D](#) [MIC4420CM-TR](#) [VN1206L](#) [614234A](#) [715780A](#) [SSM6J414TU,LF\(T](#) [751625C](#)
[IPS70R2K0CEAKMA1](#) [BSF024N03LT3 G](#) [PSMN4R2-30MLD](#) [TK31J60W5,S1VQ\(O](#) [2SK2614\(TE16L1,Q\)](#) [DMN1017UCP3-7](#)
[EFC2J004NUZTDG](#) [FCAB21350L1](#) [P85W28HP2F-7071](#) [DMN1053UCP4-7](#) [NTE2384](#) [NTE2969](#) [NTE6400A](#) [DMC2700UDMQ-7](#)
[DMN2080UCB4-7](#) [DMN61D9UWQ-13](#) [US6M2GTR](#) [DMN31D5UDJ-7](#) [SSM6P54TU,LF](#) [DMP22D4UFO-7B](#) [IPS60R3K4CEAKMA1](#)
[DMN1006UCA6-7](#) [DMN16M9UCA6-7](#) [STF5N65M6](#) [IRF40H233XTMA1](#) [IPSA70R950CEAKMA1](#) [IPSA70R2K0CEAKMA1](#) [STU5N65M6](#)
[C3M0021120D](#)