

N-Channel Enhancement Mode Field Effect Transistor

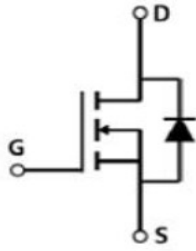

TO-220

Product Summary

- V_{DS} 100V
- I_D 70A
- $R_{DS(on)}$ (at $V_{GS}=10V$) < 8.6 mohm
- $R_{DS(on)}$ (at $V_{GS}=4.5V$) < 11 mohm
- 100% UIS Tested
- 100% ∇V_{DS} Tested

General Description

- Low $R_{DS(on)}$ & FOM
- Extremely low switching loss
- Excellent stability and uniformity
- Fast switching and soft recovery

Applications

- Power switching application
- Hard switched and high frequency circuits
- Uninterruptible power supply

■ Absolute Maximum Ratings ($T_A=25^\circ\text{C}$ unless otherwise noted)

Parameter	Symbol	Limit	Unit
Drain-source Voltage	V_{DS}	100	V
Gate-source Voltage	V_{GS}	± 20	V
Drain Current	I_D	$T_C=25^\circ\text{C}$	70
		$T_C=100^\circ\text{C}$	44.2
Pulsed Drain Current ^A	I_{DM}	280	A
Avalanche energy ^B	E_{AS}	200	mJ
Total Power Dissipation ^C	P_D	$T_C=25^\circ\text{C}$	125
		$T_C=100^\circ\text{C}$	50
Junction and Storage Temperature Range	T_J, T_{STG}	-55~+150	$^\circ\text{C}$

■ Thermal resistance

Parameter	Symbol	Typ	Max	Units
Thermal Resistance Junction-to-Ambient ^D	$R_{\theta JA}$	12	15	$^\circ\text{C/W}$
Thermal Resistance Junction-to-Ambient ^D		Steady-State	50	
Thermal Resistance Junction-to-Case	$R_{\theta JC}$	0.8	1.0	

■ Ordering Information (Example)

PREFERRED P/N	PACKING CODE	Marking	MINIMUM PACKAGE(pcs)	INNER BOX QUANTITY(pcs)	OUTER CARTON QUANTITY(pcs)	DELIVERY MODE
YJP70G10A	B1	YJP70G10A	50	/	5000	Tube



YJP70G10A

■ Electrical Characteristics (T_j=25°C unless otherwise noted)

Parameter	Symbol	Conditions	Min	Typ	Max	Units
Static Parameter						
Drain-Source Breakdown Voltage	BV _{DSS}	V _{GS} = 0V, I _D =250μA	100			V
Zero Gate Voltage Drain Current	I _{DSS}	V _{DS} =100V, V _{GS} =0V			1	μA
Gate-Body Leakage Current	I _{GSS}	V _{GS} = ±20V, V _{DS} =0V			± 100	nA
Gate Threshold Voltage	V _{GS(th)}	V _{DS} = V _{GS} , I _D =250μA	1	1.8	3	V
Static Drain-Source On-Resistance	R _{DS(ON)}	V _{GS} = 10V, I _D =20A		7.2	8.6	mΩ
		V _{GS} = 4.5V, I _D =20A		8.8	11	mΩ
Diode Forward Voltage	V _{SD}	I _S =20A, V _{GS} =0V			1.3	V
Maximum Body-Diode Continuous Current	I _S				70	A
Gate resistance	R _G	f= 1 MHz, Open drain		0.68		Ω
Dynamic Parameters						
Input Capacitance	C _{iss}	V _{DS} =50V, V _{GS} =0V, f=1MHZ		2270		pF
Output Capacitance	C _{oss}			797		
Reverse Transfer Capacitance	C _{rss}			36		
Switching Parameters						
Total Gate Charge	Q _g	V _{GS} =10V, V _{DS} =50V, I _D =25A		32		nC
Gate-Source Charge	Q _{gs}			11.1		
Gate-Drain Charge	Q _{gd}			4.78		
Reverse Recovery Charge	Q _{rr}	I _F =20A, di/dt=100A/us		84		ns
Reverse Recovery Time	t _{rr}			51.5		
Turn-on Delay Time	t _{D(on)}	V _{GS} =10V, V _{DD} =50V, I _D =25A R _{GEN} =2.2Ω		51		ns
Turn-on Rise Time	t _r			14.4		
Turn-off Delay Time	t _{D(off)}			69.2		
Turn-off fall Time	t _f			20.6		

A. Repetitive rating; pulse width limited by max. junction temperature.

B. V_{DD}=50V, R_G=25Ω, L=0.5mH.

C. P_d is based on max. junction temperature, using junction-case thermal resistance.

D. The value of R_{θJA} is measured with the device mounted on 1in2 FR-4 board with 2oz. Copper, in a still air environment with T_A=25°C. The Power dissipation P_{DSM} is based on R_{θJA} ≤ 10s and the maximum allowed junction temperature of 150°C. The value in any given application depends on the user's specific board design.



YJP70G10A

■ Typical Performance Characteristics

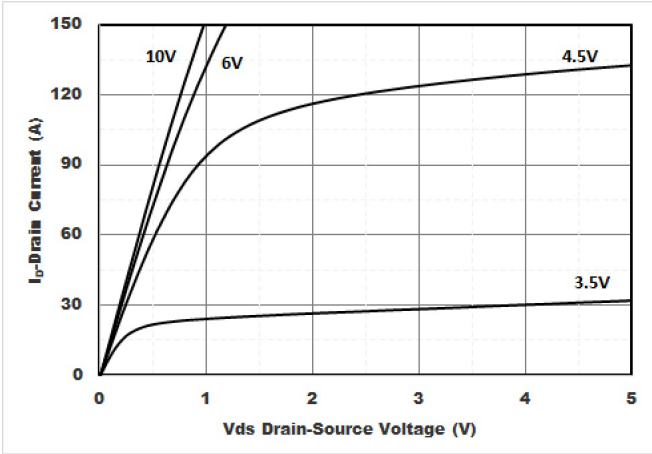

Figure1. Output Characteristics

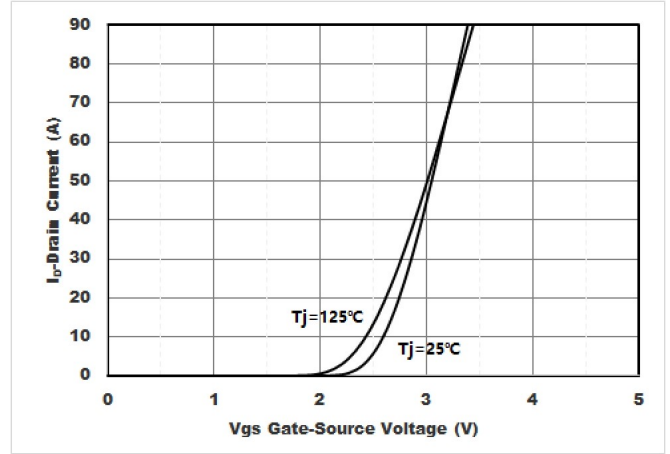

Figure2. Transfer Characteristics

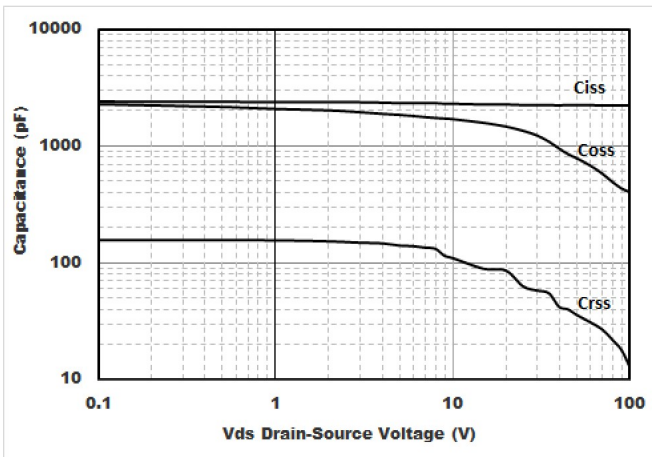

Figure3. Capacitance Characteristics

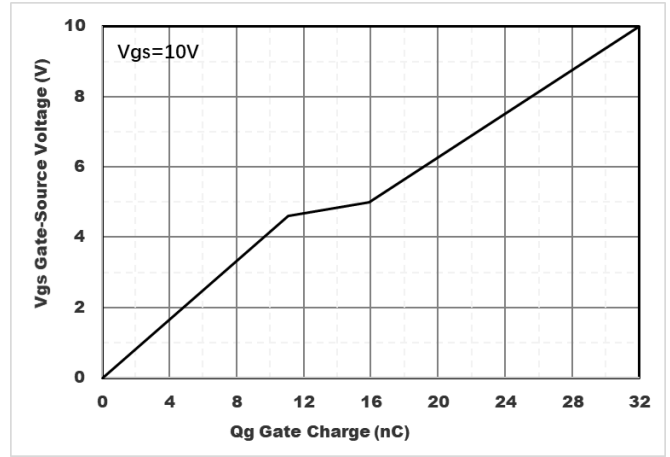

Figure4. Gate Charge

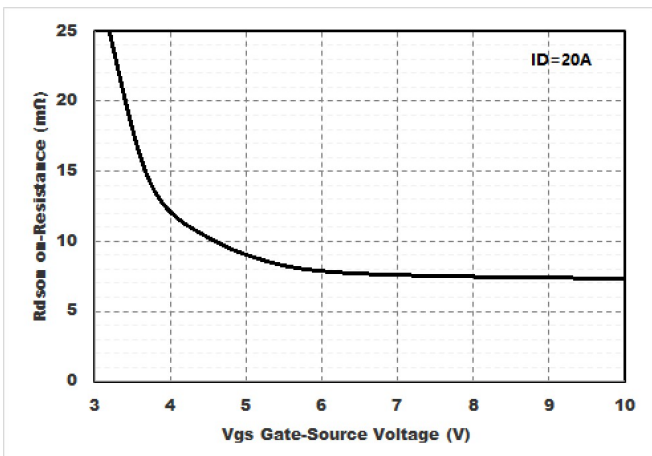

Figure5. : On-Resistance vs. Drain Current and Gate Voltage

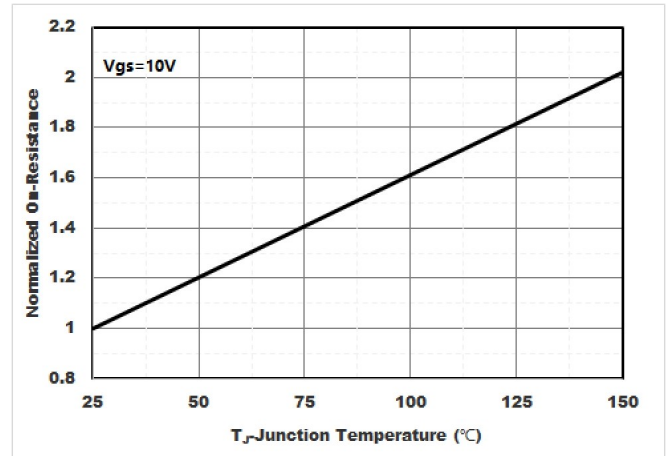

Figure6. Normalized On-Resistance



YJP70G10A

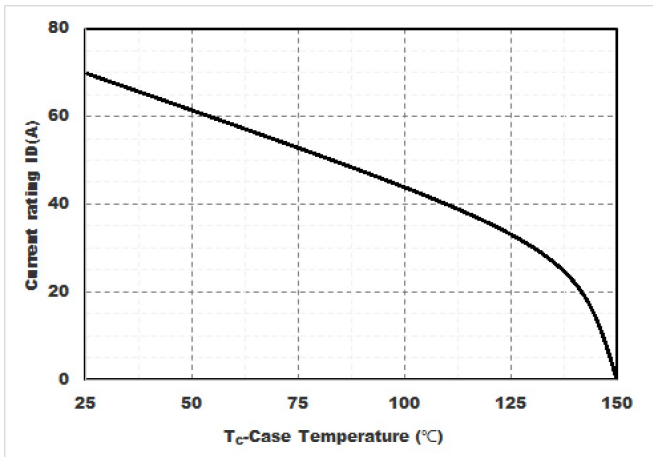

Figure7. Drain current

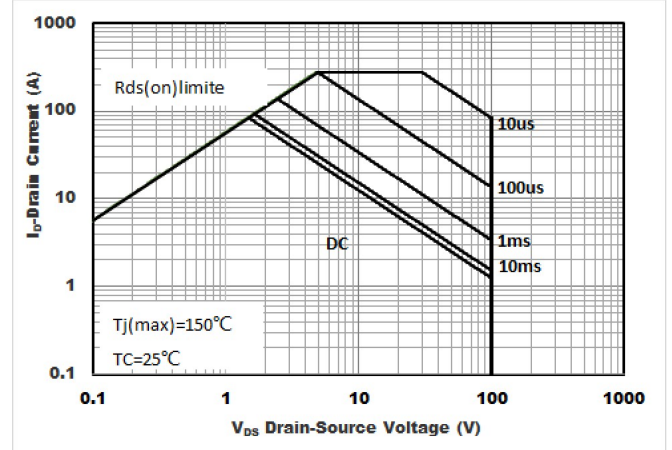

Figure8.Safe Operation Area

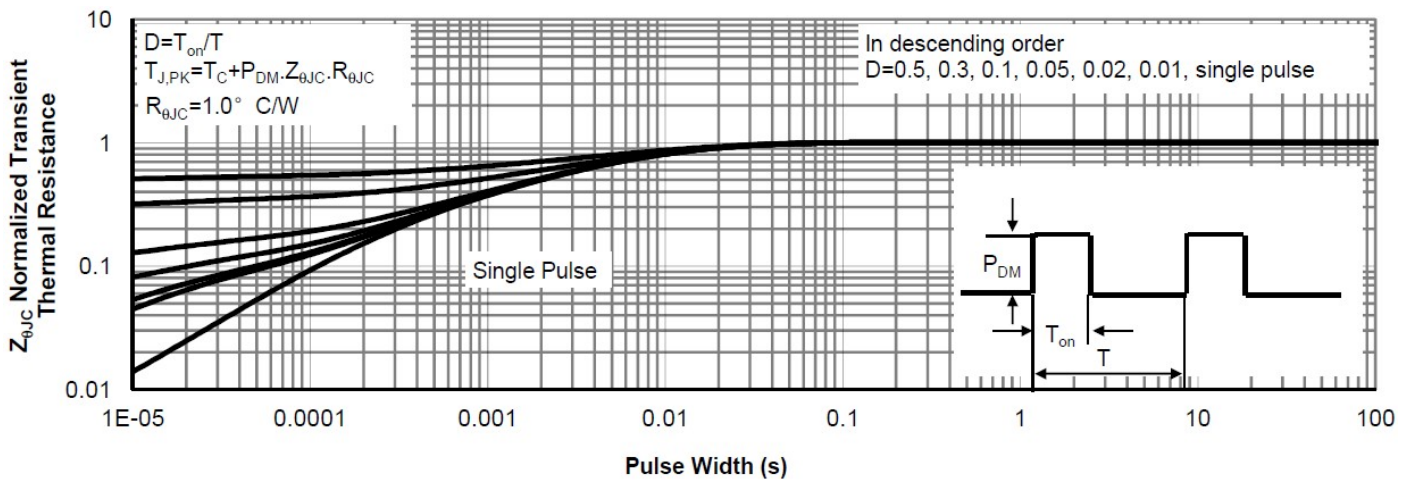
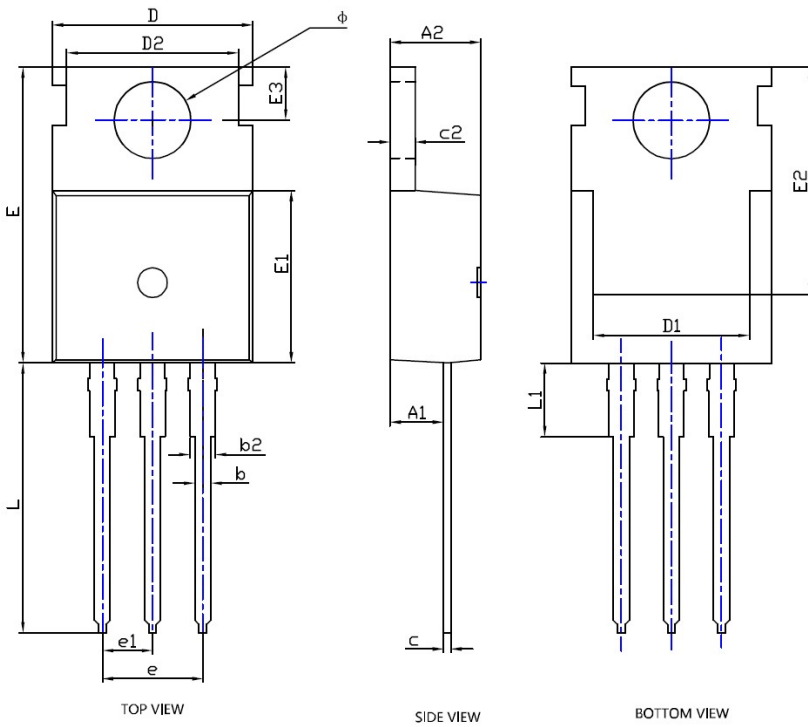

Figure9.Normalized Maximum Transient thermal impedance



YJP70G10A

■ TO-220 Package information



SYMBOL	DIMENSIONS					
	INCHES			Millimeter		
	MIN.	NDM	MAX.	MIN.	NDM	MAX.
A1	0.091	0.094	0.098	2.300	2.400	2.500
A2	0.173	0.177	0.181	4.400	4.500	4.600
b	0.028	0.031	0.035	0.700	0.800	0.900
b2	0.049	0.052	0.056	1.250	1.330	1.420
c	0.018	0.020	0.022	0.450	0.500	0.550
c2	0.050	0.051	0.052	1.270	1.300	1.330
D	0.382	---	0.402	9.700	---	10.200
D1	0.299	0.315	0.331	7.600	8.000	8.400
D2	0.335	0.343	0.350	8.500	8.700	8.900
E	0.602	0.618	0.634	15.300	15.700	16.100
E1	0.358	0.362	0.366	9.100	9.200	9.300
E2	0.497	0.505	0.513	12.630	12.830	13.030
E3	0.108BSC			2.750BSC		
e	0.200BSC			5.080BSC		
e1	0.100BSC			2.540BSC		
L	0.512	---	0.531	13.000	---	13.500
L1	---	---	0.138	---	---	3.500
φ	0.140	0.144	0.148	3.550	3.650	3.750

NOTE:
 1. PACKAGE BODY SIZES EXCLUDE MOLD FLASH AND GATE BURRS.
 2. TOLERANCE 0.1mm UNLESS OTHERWISE SPECIFIED.



YJP70G10A

Disclaimer

The information presented in this document is for reference only. Yangzhou Yangjie Electronic Technology Co., Ltd. reserves the right to make changes without notice for the specification of the products displayed herein to improve reliability, function or design or otherwise.

The product listed herein is designed to be used with ordinary electronic equipment or devices, and not designed to be used with equipment or devices which require high level of reliability and the malfunction of which would directly endanger human life (such as medical instruments, transportation equipment, aerospace machinery, nuclear-reactor controllers, fuel controllers and other safety devices), Yangjie or anyone on its behalf, assumes no responsibility or liability for any damages resulting from such improper use of sale.

This publication supersedes & replaces all information previously supplied. For additional information, please visit our website [http:// www.21yangjie.com](http://www.21yangjie.com) , or consult your nearest Yangjie's sales office for further assistance.

X-ON Electronics

Largest Supplier of Electrical and Electronic Components

Click to view similar products for [MOSFET](#) category:

Click to view products by [Yangjie](#) manufacturer:

Other Similar products are found below :

[IRFD120](#) [JANTX2N5237](#) [BUK455-60A/B](#) [MIC4420CM-TR](#) [VN1206L](#) [NDP4060](#) [SI4482DY](#) [IPS70R2K0CEAKMA1](#) [SQD23N06-31L-GE3](#)
[TK16J60W,S1VQ\(O](#) [2SK2614\(TE16L1,Q\)](#) [DMN1017UCP3-7](#) [DMN1053UCP4-7](#) [SQJ469EP-T1-GE3](#) [NTE2384](#) [DMC2700UDMQ-7](#)
[DMN2080UCB4-7](#) [DMN61D9UWQ-13](#) [US6M2GTR](#) [DMN31D5UDJ-7](#) [DMP22D4UFO-7B](#) [DMN1006UCA6-7](#) [DMN16M9UCA6-7](#)
[STF5N65M6](#) [IRF40H233XTMA1](#) [STU5N65M6](#) [DMN6022SSD-13](#) [DMN13M9UCA6-7](#) [DMTH10H4M6SPS-13](#) [DMN2990UFB-7B](#)
[IPB80P04P405ATMA2](#) [2N7002W-G](#) [MCAC30N06Y-TP](#) [MCQ7328-TP](#) [BXP7N65D](#) [BXP4N65F](#) [AOL1454G](#) [WMJ80N60C4](#) [BXP2N20L](#)
[BXP2N65D](#) [BXT1150N10J](#) [BXT1700P06M](#) [TSM60NB380CP ROG](#) [RQ7L055BGTCR](#) [DMNH15H110SK3-13](#) [SLF10N65ABV2](#)
[BSO203SP](#) [BSO211P](#) [IPA60R230P6](#) [IPA60R460CE](#)