

### Features:

- Low Power Programmable Oscillator
- Any frequency between 1 MHz and 110 MHz accurate to 6 decimal places
- 100% pin-to-pin drop-in replacement to quartz-based XO
- Operating temperature from -40°C to 85°C.
- Low power consumption of 3.5 mA typical at 1.8V
- Standby mode for longer battery life, fast startup time of 5 ms
- LVC MOS/HCMOS compatible output
- Industry-standard packages: 2.0 x 1.6, 2.5 x 2.0, 3.2 x 2.5, 5.0 x 3.2, 7.0 x 5.0 mm x mm

### Applications:

- Ideal for DSC, DVC, DVR, IP CAM, Tablets, e-Books, SSD, GPON, EPON, etc
- Ideal for high-speed serial protocols such as: USB, SATA, SAS, Firewire, 100M / 1G / 10G Ethernet, etc.

## Electrical Specifications

**Table 1. Electrical Characteristics**

All Min and Max limits are specified over temperature and rated operating voltage with 15 pF output load unless otherwise stated. Typical values are at 25°C and nominal supply voltage.

Parameters	Symbol	Min.	Typ.	Max.	Unit	Condition
<b>Frequency Range</b>						
Output Frequency Range	f	1	–	110	MHz	
<b>Frequency Stability and Aging</b>						
Frequency Stability	F_stab	-20	–	+20	ppm	Inclusive of initial tolerance at 25°C, 1st year aging at 25°C, and variations over operating temperature, rated power supply voltage and load.
		-25	–	+25	ppm	
		-50	–	+50	ppm	
<b>Operating Temperature Range</b>						
Operating Temperature Range	T_use	-20	–	+70	°C	Extended Commercial
		-40	–	+85	°C	Industrial
<b>Supply Voltage and Current Consumption</b>						
Supply Voltage	Vdd	1.62	1.8	1.98	V	
		2.25	2.5	2.75	V	
		2.52	2.8	3.08	V	
		2.7	3.0	3.3	V	
		2.97	3.3	3.63	V	
		2.25	–	3.63	V	
Current Consumption	Idd	–	3.8	4.5	mA	No load condition, f = 20 MHz, Vdd = 2.8V to 3.3V
		–	3.7	4.2	mA	No load condition, f = 20 MHz, Vdd = 2.5V
		–	3.5	4.1	mA	No load condition, f = 20 MHz, Vdd = 1.8V
OE Disable Current	I_OD	–	–	4.2	mA	Vdd = 2.5V to 3.3V, OE = GND, Output in high-Z state
		–	–	4.0	mA	Vdd = 1.8V, OE = GND, Output in high-Z state
Standby Current	I_std	–	2.1	4.3	μA	ST = GND, Vdd = 2.8V to 3.3V, Output is weakly pulled down
		–	1.1	2.5	μA	ST = GND, Vdd = 2.5V, Output is weakly pulled down
		–	0.2	1.3	μA	ST = GND, Vdd = 1.8V, Output is weakly pulled down
<b>LVC MOS Output Characteristics</b>						
Duty Cycle	DC	45	–	55	%	All Vdds. See Duty Cycle definition in Figure 3 and Footnote 8
Rise/Fall Time	Tr, Tf	–	1	2	ns	Vdd = 2.5V, 2.8V, 3.0V or 3.3V, 20% - 80%
		–	1.3	2.5	ns	Vdd = 1.8V, 20% - 80%
		–	–	2	ns	Vdd = 2.25V - 3.63V, 20% - 80%
Output High Voltage	VOH	90%	–	–	Vdd	IOH = -4 mA (Vdd = 3.0V or 3.3V) IOH = -3 mA (Vdd = 2.8V and Vdd = 2.5V) IOH = -2 mA (Vdd = 1.8V)
Output Low Voltage	VOL	–	–	10%	Vdd	IOL = 4 mA (Vdd = 3.0V or 3.3V) IOL = 3 mA (Vdd = 2.8V and Vdd = 2.5V) IOL = 2 mA (Vdd = 1.8V)

**Table 1. Electrical Characteristics (continued)**

Parameters	Symbol	Min.	Typ.	Max.	Unit	Condition
<b>Input Characteristics</b>						
Input High Voltage	V <sub>IH</sub>	70%	–	–	V <sub>dd</sub>	Pin 1, OE or $\overline{ST}$
Input Low Voltage	V <sub>IL</sub>	–	–	30%	V <sub>dd</sub>	Pin 1, OE or $\overline{ST}$
Input Pull-up Impedance	Z <sub>in</sub>	50	87	150	k $\Omega$	Pin 1, OE logic high or logic low, or $\overline{ST}$ logic high
		2	–	–	M $\Omega$	Pin 1, $\overline{ST}$ logic low
<b>Startup and Resume Timing</b>						
Startup Time	T <sub>start</sub>	–	–	5	ms	Measured from the time V <sub>dd</sub> reaches its rated minimum value
Enable/Disable Time	T <sub>oe</sub>	–	–	130	ns	f = 110 MHz. For other frequencies, T <sub>oe</sub> = 100 ns + 3 * cycles
Resume Time	T <sub>resume</sub>	–	–	5	ms	Measured from the time ST pin crosses 50% threshold
<b>Jitter</b>						
RMS Period Jitter	T <sub>jitt</sub>	–	1.8	3	ps	f = 75 MHz, V <sub>dd</sub> = 2.5V, 2.8V, 3.0V or 3.3V
		–	1.8	3	ps	f = 75 MHz, V <sub>dd</sub> = 1.8V
Peak-to-peak Period Jitter	T <sub>pk</sub>	–	12	25	ps	f = 75 MHz, V <sub>dd</sub> = 2.5V, 2.8V, 3.0V or 3.3V
		–	14	30	ps	f = 75 MHz, V <sub>dd</sub> = 1.8V
RMS Phase Jitter (random)	T <sub>phj</sub>	–	0.5	0.9	ps	f = 75 MHz, Integration bandwidth = 900 kHz to 7.5 MHz
		–	1.3	2	ps	f = 75 MHz, Integration bandwidth = 12 kHz to 20 MHz

**Table 2. Pin Description**

Pin	Symbol	Functionality
1	OE/ $\overline{ST}$ /NC	Output Enable H <sup>[1]</sup> : specified frequency output L: output is high impedance. Only output driver is disabled.
		Standby H <sup>[1]</sup> : specified frequency output L: output is low (weak pull down). Device goes to sleep mode. Supply current reduces to I <sub>std</sub> .
		No Connect Any voltage between 0 and V <sub>dd</sub> or Open <sup>[1]</sup> : Specified frequency output. Pin 1 has no function.
2	GND	Power Electrical ground
3	OUT	Output Oscillator output
4	VDD	Power Power supply voltage <sup>[2]</sup>

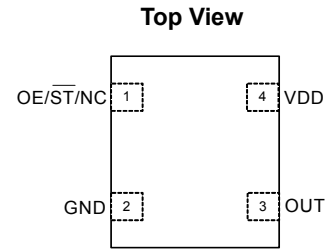
**Figure 1. Pin Assignments**
**Notes:**

- In OE or  $\overline{ST}$  mode, a pull-up resistor of 10 k $\Omega$  or less is recommended if pin 1 is not externally driven. If pin 1 needs to be left floating, use the NC option.
- A capacitor of value 0.1  $\mu$ F or higher between V<sub>dd</sub> and GND is required.

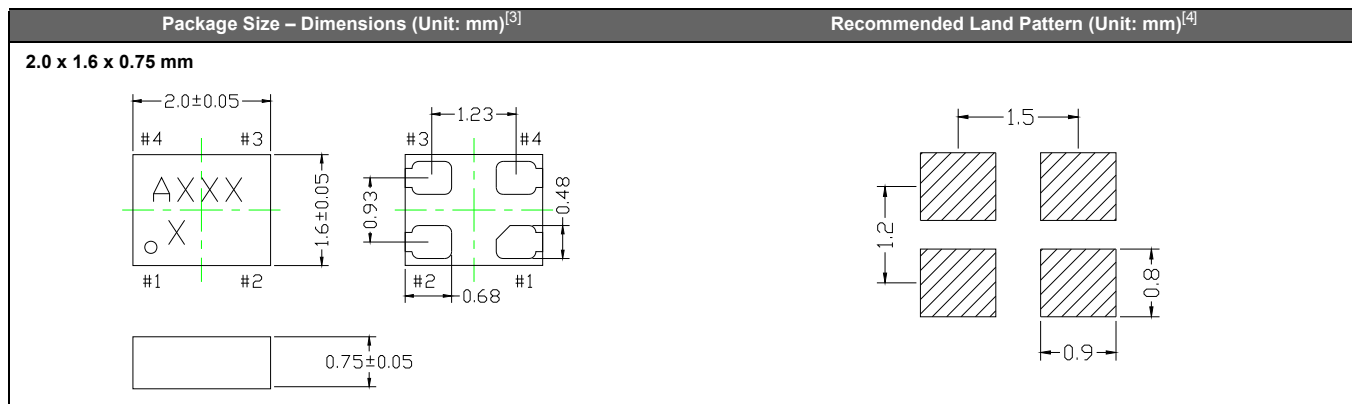
**Dimensions and Patterns**

**Dimensions and Patterns**

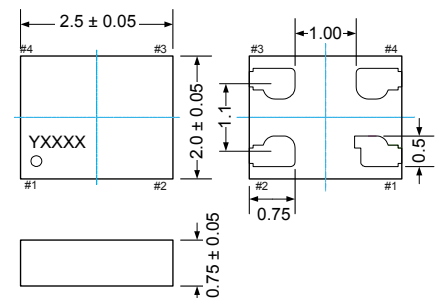
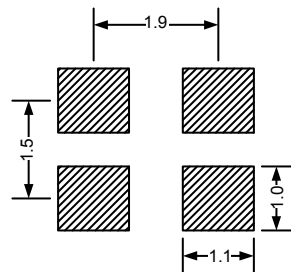
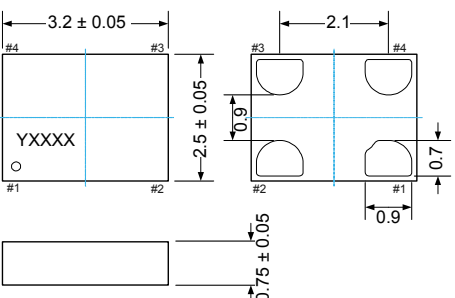
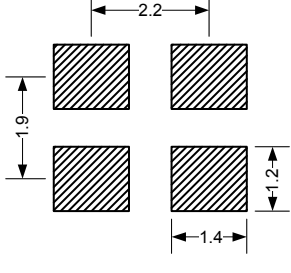
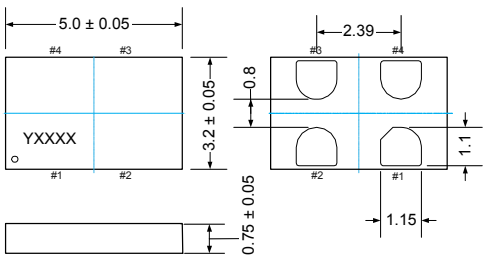
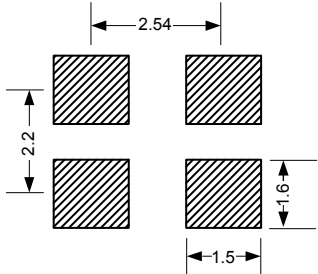
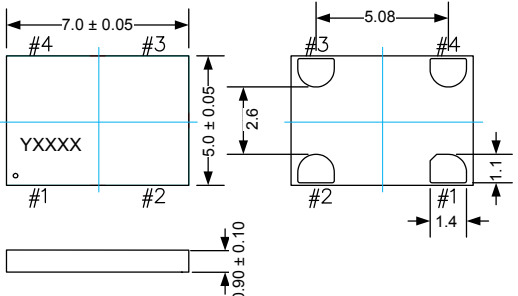
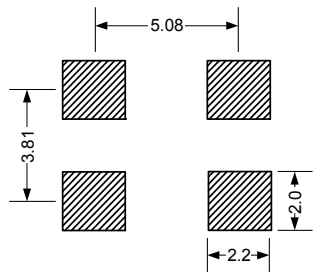
Package Size – Dimensions (Unit: mm) <sup>[3]</sup>	Recommended Land Pattern (Unit: mm) <sup>[4]</sup>
<p><b>2.5 x 2.0 x 0.75 mm</b></p>  <p>Top view shows a 2.5 x 2.0 mm footprint with pins #1, #2, #3, #4. Dimensions include 2.5 ± 0.05 mm, 2.0 ± 0.05 mm, 0.75 ± 0.05 mm, 1.00 mm, 0.5 mm, 0.75 mm, and 1.1 mm. The top marking is YXXXX.</p>	 <p>Land pattern shows four pins with dimensions: 1.9 mm between pins, 1.5 mm pin height, 1.1 mm pin width, and 1.0 mm pin spacing.</p>
<p><b>3.2 x 2.5 x 0.75 mm</b></p>  <p>Top view shows a 3.2 x 2.5 mm footprint with pins #1, #2, #3, #4. Dimensions include 3.2 ± 0.05 mm, 2.5 ± 0.05 mm, 0.75 ± 0.05 mm, 2.1 mm, 0.9 mm, 0.7 mm, and 0.9 mm. The top marking is YXXXX.</p>	 <p>Land pattern shows four pins with dimensions: 2.2 mm between pins, 1.9 mm pin height, 1.4 mm pin width, and 1.2 mm pin spacing.</p>
<p><b>5.0 x 3.2 x 0.75 mm</b></p>  <p>Top view shows a 5.0 x 3.2 mm footprint with pins #1, #2, #3, #4. Dimensions include 5.0 ± 0.05 mm, 3.2 ± 0.05 mm, 0.75 ± 0.05 mm, 2.39 mm, 0.8 mm, 1.1 mm, and 1.15 mm. The top marking is YXXXX.</p>	 <p>Land pattern shows four pins with dimensions: 2.54 mm between pins, 2.2 mm pin height, 1.6 mm pin width, and 1.5 mm pin spacing.</p>
<p><b>7.0 x 5.0 x 0.90 mm</b></p>  <p>Top view shows a 7.0 x 5.0 mm footprint with pins #1, #2, #3, #4. Dimensions include 7.0 ± 0.05 mm, 5.0 ± 0.05 mm, 0.90 ± 0.10 mm, 5.08 mm, 2.6 mm, 1.1 mm, and 1.4 mm. The top marking is YXXXX.</p>	 <p>Land pattern shows four pins with dimensions: 5.08 mm between pins, 3.81 mm pin height, 2.0 mm pin width, and 2.2 mm pin spacing.</p>

**Notes:**

3. Top marking: Y denotes manufacturing origin and XXXX denotes manufacturing lot number. The value of “Y” will depend on the assembly location of the device.
4. A capacitor of value 0.1 μF or higher between Vdd and GND is required.

**PART Number Guide**

Quartz Crystal Oscillator	Dimensions	Frequency (Hz)	Supply voltage (V)	Frequency Stability Overall (ppm)	Output	Pin	Material	Operating Temp. Range
O	7050	100M	E	E	H	4	M	I

**Table 3. Absolute Maximum Limits**

Attempted operation outside the absolute maximum ratings may cause permanent damage to the part. Actual performance of the IC is only guaranteed within the operational specifications, not at absolute maximum ratings.

Parameter	Min.	Max.	Unit
Storage Temperature	-65	150	°C
Vdd	-0.5	4	V
Electrostatic Discharge	-	2000	V
Soldering Temperature (follow standard Pb free soldering guidelines)	-	260	°C
Junction Temperature <sup>[5]</sup>	-	150	°C

Note:

5. Exceeding this temperature for extended period of time may damage the device.

**Table 4. Thermal Consideration<sup>[6]</sup>**

Package	$\theta_{JA}$ , 4 Layer Board (°C/W)	$\theta_{JA}$ , 2 Layer Board (°C/W)	$\theta_{JC}$ , Bottom (°C/W)
7050	142	273	30
5032	97	199	24
3225	109	212	27
2520	117	222	26
2016	152	252	36

Note:

6. Refer to JESD51 for  $\theta_{JA}$  and  $\theta_{JC}$  definitions, and reference layout used to determine the  $\theta_{JA}$  and  $\theta_{JC}$  values in the above table.

**Table 5. Maximum Operating Junction Temperature<sup>[7]</sup>**

Max Operating Temperature (ambient)	Maximum Operating Junction Temperature
70°C	80°C
85°C	95°C

Note:

7. Datasheet specifications are not guaranteed if junction temperature exceeds the maximum operating junction temperature.

**Table 6. Environmental Compliance**

Parameter	Condition/Test Method
Mechanical Shock	MIL-STD-883F, Method 2002
Mechanical Vibration	MIL-STD-883F, Method 2007
Temperature Cycle	JESD22, Method A104
Solderability	MIL-STD-883F, Method 2003
Moisture Sensitivity Level	MSL1 @ 260°C

Test Circuit and Waveform<sup>[8]</sup>

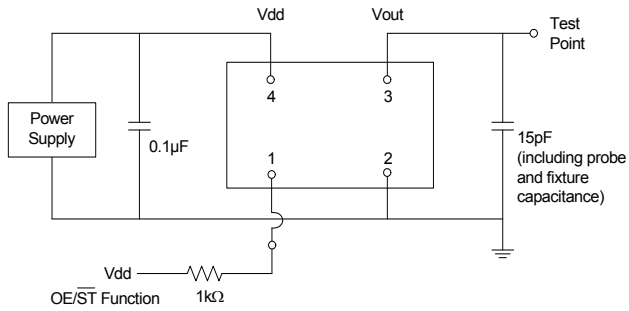

Figure 2. Test Circuit

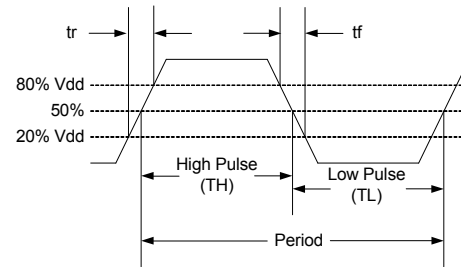
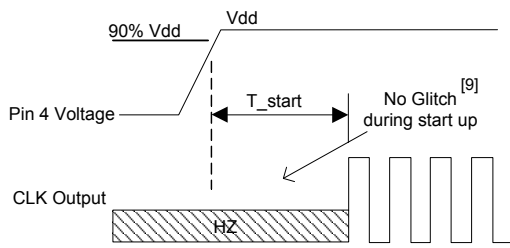

Figure 3. Waveform

Note:

8. Duty Cycle is computed as Duty Cycle = TH/Period.

Timing Diagrams



T\_start: Time to start from power-off

Figure 4. Startup Timing (OE/ST Mode)

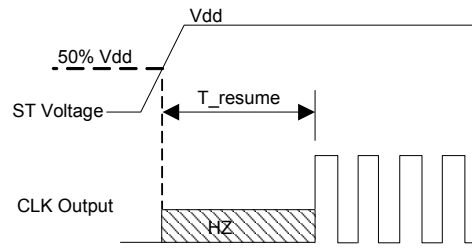

T\_resume: Time to resume from ST

Figure 5. Standby Resume Timing (ST Mode Only)

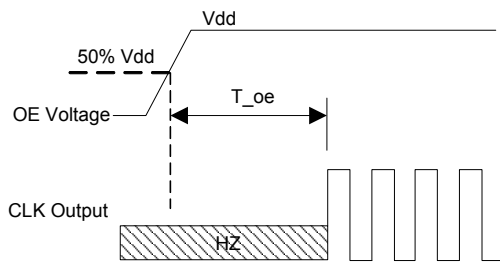

T\_oe: Time to re-enable the clock output

Figure 6. OE Enable Timing (OE Mode Only)

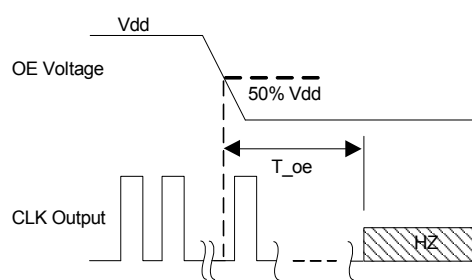

T\_oe: Time to put the output in High Z mode

Figure 7. OE Disable Timing (OE Mode Only)

Note:

9. YSO8008MR has “no runt” pulses and “no glitch” output during startup or resume.

Performance Plots<sup>[10]</sup>

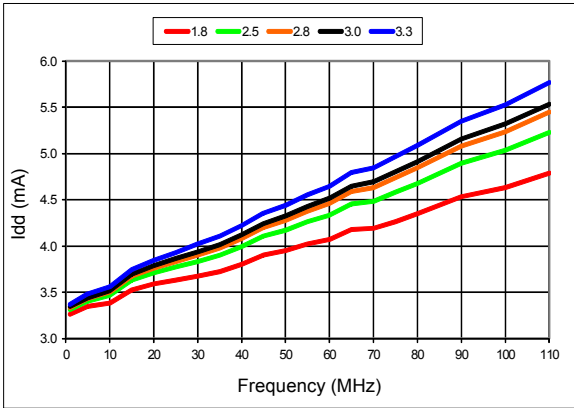

Figure 8. Idd vs Frequency

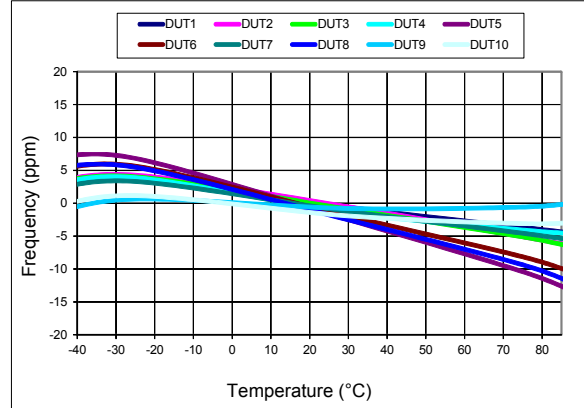

Figure 9. Frequency vs Temperature

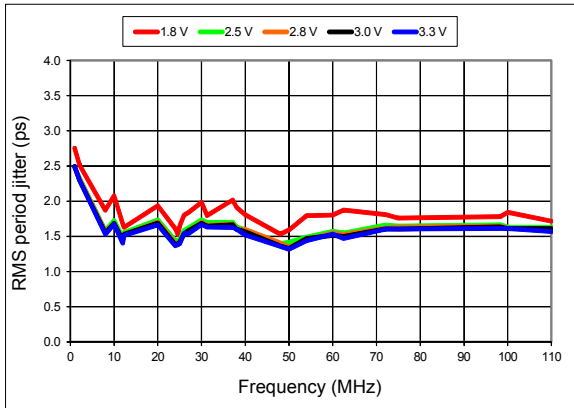

Figure 10. RMS Period Jitter vs Frequency

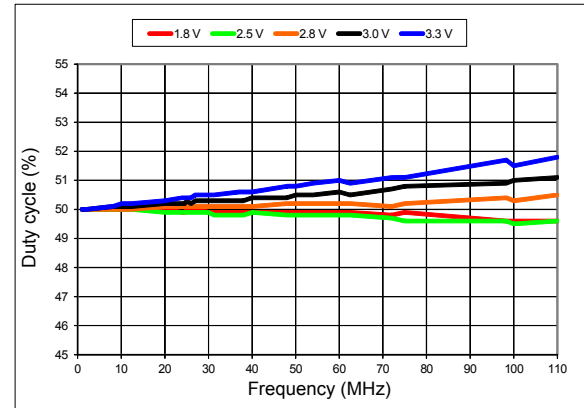

Figure 11. Duty Cycle vs Frequency

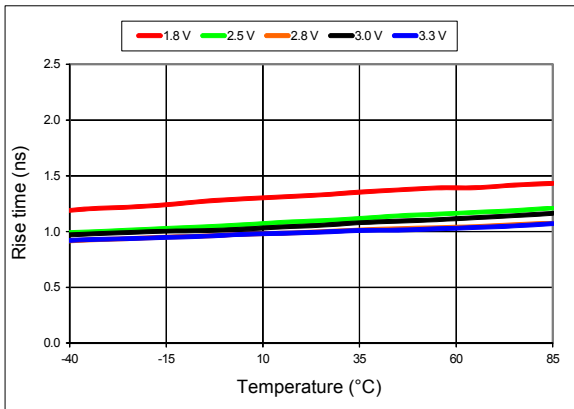

Figure 12. 20%-80% Rise Time vs Temperature

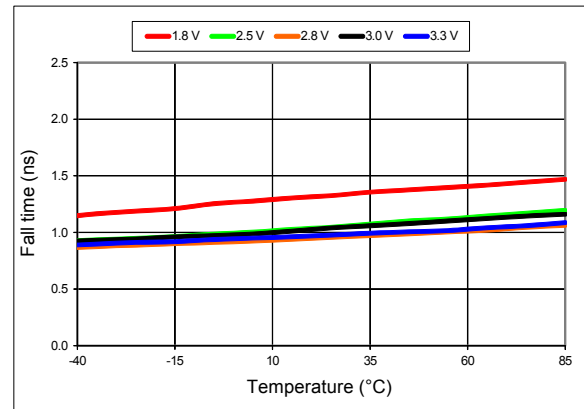

Figure 13. 20%-80% Fall Time vs Temperature

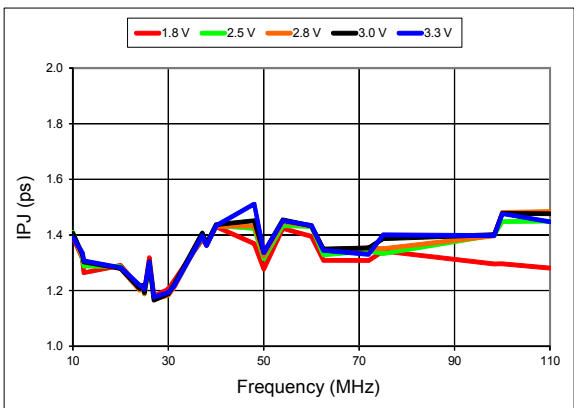

Figure 14. RMS Integrated Phase Jitter Random (12 kHz to 20 MHz) vs Frequency<sup>[11]</sup>

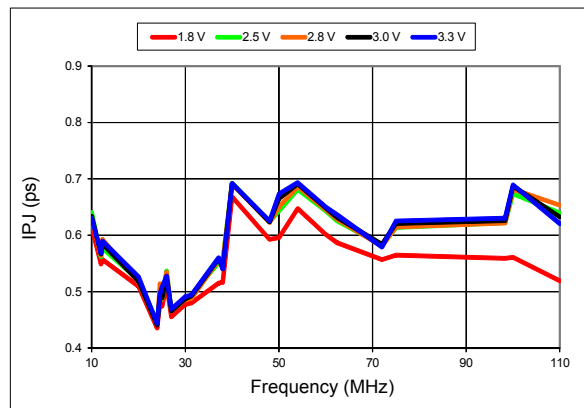

Figure 15. RMS Integrated Phase Jitter Random (900 kHz to 20 MHz) vs Frequency<sup>[11]</sup>

Notes:

- 10. All plots are measured with 15 pF load at room temperature, unless otherwise stated.
- 11. Phase noise plots are measured with Agilent E5052B signal source analyzer. Integration range is up to 5 MHz for carrier frequencies below 40 MHz.

### Programmable Drive Strength

The YSO8008MR includes a programmable drive strength feature to provide a simple, flexible tool to optimize the clock rise/fall time for specific applications. Benefits from the programmable drive strength feature are:

- Improves system radiated electromagnetic interference (EMI) by slowing down the clock rise/fall time
- Improves the downstream clock receiver's (RX) jitter by decreasing (speeding up) the clock rise/fall time.
- Ability to drive large capacitive loads while maintaining full

### EMI Reduction by Slowing Rise/Fall Time

Figure 16 shows the harmonic power reduction as the rise/fall times are increased (slowed down). The rise/fall times are expressed as a ratio of the clock period. For the ratio of 0.05, the signal is very close to a square wave. For the ratio of 0.45, the rise/fall times are very close to near-triangular waveform. These results, for example, show that the 11th clock harmonic can be reduced by 35 dB if the rise/fall edge is increased from 5% of the period to 45% of the period.

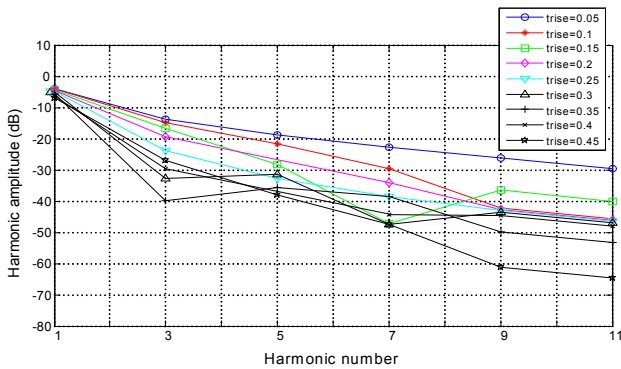

Figure 16. Harmonic EMI reduction as a Function of Slower Rise/Fall Time

### Jitter Reduction with Faster Rise/Fall Time

Power supply noise can be a source of jitter for the downstream chipset. One way to reduce this jitter is to speed up the rise/fall time of the input clock. Some chipsets may also require faster rise/fall time in order to reduce their sensitivity to this type of jitter. Refer to the Rise/Fall Time Tables (Table 7 to Table 11) to determine the proper drive strength.

### High Output Load Capability

The rise/fall time of the input clock varies as a function of the actual capacitive load the clock drives. At any given drive strength, the rise/fall time becomes slower as the output load increases. As an example, for a 3.3V YSO8008 MR device with default drive strength setting, the typical rise/fall time is 1 ns for 15 pF output load. The typical rise/fall time slows down to 2.6 ns when the output load increases to 45 pF. One can choose to speed up the rise/fall time to 1.83 ns by then increasing the drive strength setting on the YSO8008MR.

The YSO8008MR can support up to 60 pF or higher in maximum capacitive loads with drive strength settings. Refer to the Rise/Fall Time Tables (Table 7 to 11) to determine the proper drive strength for the desired combination of output load vs. rise/fall time.

### YSO8008MR Drive Strength Selection

Tables 7 through 11 define the rise/fall time for a given capacitive load and supply voltage.

1. Select the table that matches the YSO8008MR nominal supply voltage (1.8V, 2.5V, 2.8V, 3.0V, 3.3V).
2. Select the capacitive load column that matches the application requirement (5 pF to 60 pF)
3. Under the capacitive load column, select the desired rise/fall times.
4. The left-most column represents the part number code for the corresponding drive strength.
5. Add the drive strength code to the part number for ordering purposes.

**Rise/Fall Time (20% to 80%) vs C<sub>LOAD</sub> Tables**
**Table 7. V<sub>dd</sub> = 1.8V Rise/Fall Times for Specific C<sub>LOAD</sub>**

Rise/Fall Time Typ (ns)					
Drive Strength \ C <sub>LOAD</sub>	5 pF	15 pF	30 pF	45 pF	60 pF
L	6.16	11.61	22.00	31.27	39.91
A	3.19	6.35	11.00	16.01	21.52
R	2.11	4.31	7.65	10.77	14.47
B	1.65	3.23	5.79	8.18	11.08
T	0.93	1.91	3.32	4.66	6.48
E	0.78	1.66	2.94	4.09	5.74
U	0.70	1.48	2.64	3.68	5.09
F or "-": default	0.65	1.30	2.40	3.35	4.56

**Table 8. V<sub>dd</sub> = 2.5V Rise/Fall Times for Specific C<sub>LOAD</sub>**

Rise/Fall Time Typ (ns)					
Drive Strength \ C <sub>LOAD</sub>	5 pF	15 pF	30 pF	45 pF	60 pF
L	4.13	8.25	12.82	21.45	27.79
A	2.11	4.27	7.64	11.20	14.49
R	1.45	2.81	5.16	7.65	9.88
B	1.09	2.20	3.88	5.86	7.57
T	0.62	1.28	2.27	3.51	4.45
E or "-": default	0.54	1.00	2.01	3.10	4.01
U	0.43	0.96	1.81	2.79	3.65
F	0.34	0.88	1.64	2.54	3.32

**Table 9. V<sub>dd</sub> = 2.8V Rise/Fall Times for Specific C<sub>LOAD</sub>**

Rise/Fall Time Typ (ns)					
Drive Strength \ C <sub>LOAD</sub>	5 pF	15 pF	30 pF	45 pF	60 pF
L	3.77	7.54	12.28	19.57	25.27
A	1.94	3.90	7.03	10.24	13.34
R	1.29	2.57	4.72	7.01	9.06
B	0.97	2.00	3.54	5.43	6.93
T	0.55	1.12	2.08	3.22	4.08
E or "-": default	0.44	1.00	1.83	2.82	3.67
U	0.34	0.88	1.64	2.52	3.30
F	0.29	0.81	1.48	2.29	2.99

**Table 10. V<sub>dd</sub> = 3.0V Rise/Fall Times for Specific C<sub>LOAD</sub>**

Rise/Fall Time Typ (ns)					
Drive Strength \ C <sub>LOAD</sub>	5 pF	15 pF	30 pF	45 pF	60 pF
L	3.60	7.21	11.97	18.74	24.30
A	1.84	3.71	6.72	9.86	12.68
R	1.22	2.46	4.54	6.76	8.62
B	0.89	1.92	3.39	5.20	6.64
T or "-": default	0.51	1.00	1.97	3.07	3.90
E	0.38	0.92	1.72	2.71	3.51
U	0.30	0.83	1.55	2.40	3.13
F	0.27	0.76	1.39	2.16	2.85

**Table 11. V<sub>dd</sub> = 3.3V Rise/Fall Times for Specific C<sub>LOAD</sub>**

Rise/Fall Time Typ (ns)					
Drive Strength \ C <sub>LOAD</sub>	5 pF	15 pF	30 pF	45 pF	60 pF
L	3.39	6.88	11.63	17.56	23.59
A	1.74	3.50	6.38	8.98	12.19
R	1.16	2.33	4.29	6.04	8.34
B	0.81	1.82	3.22	4.52	6.33
T or "-": default	0.46	1.00	1.86	2.60	3.84
E	0.33	0.87	1.64	2.30	3.35
U	0.28	0.79	1.46	2.05	2.93
F	0.25	0.72	1.31	1.83	2.61



### Pin 1 Configuration Options (OE, $\overline{ST}$ , or NC)

Pin 1 of the YSO8008MR can be factory-programmed to support three modes: Output Enable (OE), standby ( $\overline{ST}$ ) or No Connect (NC).

#### Output Enable (OE) Mode

In the OE mode, applying logic Low to the OE pin only disables the output driver and puts it in Hi-Z mode. The core of the device continues to operate normally. Power consumption is reduced due to the inactivity of the output. When the OE pin is pulled High, the output is typically enabled in  $<1 \mu\text{s}$ .

#### Standby ( $\overline{ST}$ ) Mode

In the  $\overline{ST}$  mode, a device enters into the standby mode when Pin 1 pulled Low. All internal circuits of the device are turned off. The current is reduced to a standby current, typically in the range of a few  $\mu\text{A}$ . When  $\overline{ST}$  is pulled High, the device goes through the “resume” process, which can take up to 5 ms.

#### No Connect (NC) Mode

In the NC mode, the device always operates in its normal mode and outputs the specified frequency regardless of the logic level on pin 1.

Table 12 below summarizes the key relevant parameters in the operation of the device in OE,  $\overline{ST}$ , or NC mode.

**Table 12. OE vs.  $\overline{ST}$  vs. NC**

	OE	$\overline{ST}$	NC
Active current 20 MHz (max, 1.8V)	4.1 mA	4.1 mA	4.1 mA
OE disable current (max, 1.8V)	4 mA	N/A	N/A
Standby current (typical 1.8V)	N/A	0.6 $\mu\text{A}$	N/A
OE enable time at 20 MHz (max)	200 ns	N/A	N/A
Resume time from standby (max, all frequency)	N/A	5 ms	N/A
Output driver in OE disable/standby mode	High Z	weak pull-down	N/A

### Output on Startup and Resume

The YSO8008MR comes with gated output. Its clock output is accurate to the rated frequency stability within the first pulse from initial device startup or resume from the standby mode.

In addition, the YSO8008MR features “no runt” pulses and “no glitch” output during startup or resume as shown in the waveform captures in Figure 17 and Figure 18.



**Figure 17. Startup Waveform vs. Vdd**

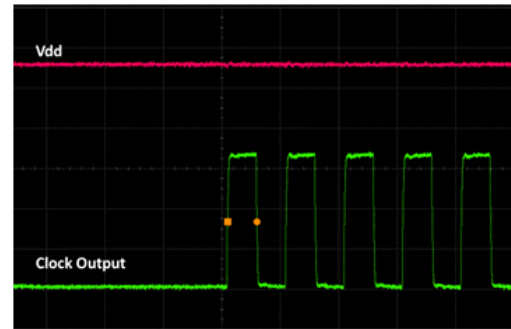

**Figure 18. Startup Waveform vs. Vdd (Zoomed-in View of Figure 17)**

## X-ON Electronics

Largest Supplier of Electrical and Electronic Components

*Click to view similar products for [Standard Clock Oscillators](#) category:*

*Click to view products by [Yangxing](#) manufacturer:*

Other Similar products are found below :

[601252](#) [F335-25](#) [F535L-33.333](#) [F535L-50](#) [ASV-20.000MHZ-LR-T](#) [ECS-2018-160-BN-TR](#) [MXO45HS-2C-66.6666MHZ](#) [SiT1602BI-22-33E-50.000000E](#) [SiT8209AI-32-33E-125.000000](#) [SIT8918AA-11-33S-50.000000G](#) [SM4420TEV-40.0M-T1K](#) [SMA4306-TL-H](#) [F335-24](#) [F335-40](#) [F535L-10](#) [F535L-12](#) [F535L-16](#) [F535L-24](#) [F535L-27](#) [F535L-48](#) [PE7744DW-100.0M](#) [ASF1-3.686MHZ-N-K-S](#) [ASV-4.000MHZ-LCS-T](#) [XLH735025.000JU4I8](#) [XLP725125.000JU6I8](#) [XO57CTECNA3M6864](#) [ECS-2100A-147.4](#) [601251](#) [EP16E7E2H26.000MTR](#) [SiT8503AI-18-33E-0.200000X](#) [SIT8918AA-11-33S-16.000000G](#) [SIT9122AI2C233E300.000000X](#) [XO37CTECNA20M](#) [XO3003](#) [9120AC-2D2-33E212.500000](#) [9102AI-243N25E100.00000](#) [8208AC-82-18E-25.00000](#) [ASDK2-32.768KHZ-LR-T3](#) [8008AI-72-XXE-24.545454E](#) [8004AC-13-33E-133.33000X](#) [AS-4.9152-16-SMD-TR](#) [ASFL1-48.000MHZ-LC-T](#) [632L3I004M00000](#) [SIT8920AM-31-33E-25.0000](#) [DSC1028DI2-019.2000](#) [9121AC-2C3-25E100.00000](#) [9102AI-233N33E100.00000X](#) [9102AI-233N25E200.00000](#) [9102AI-232H25S125.00000](#) [9102AI-133N25E200.00000](#)