

Programmable Crystal Oscillator YSO690PR



Applications

- Consumer
- Industrial

Features

- Fast Delivery
- PLL Circuit Provides Wide Frequency Range Application (1 ~ 200MHz)
- Low Jitter Design with New Developed IC
- Package Size: 2.0*1.6, 2.5*2.0, 3.2*2.5, 5.0*3.2, 7.0*5.0mm

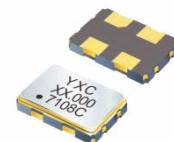

Specifications (规格参数)

Item / Type	CMOS		
Supply Voltage 电源电压	1.8 V	2.5 V	3.3 V
Frequency Range 额定频率范围	1MHz ~ 125MHz	1MHz ~ 200MHz	1MHz ~ 200MHz
Supply Voltage Variation (VDD)10% 电压范围	1.62V ~ 1.98V	2.25V ~ 2.75V	2.97V ~ 3.63V
Standby Current 待机电流	400uA		
Frequency Tolerance 频率偏差	±30ppm, ±50ppm or specify		
Output Load 输出负载	15pF		
Operating Temperature Range 工作温度	-40~+85°C, or specify		
Storage Temperature Range 储存温度	-55~+150°C		
Voltage VOH (Min.) / VOL (Max.) 输出电压	VOH = 90%VDD / VOL = 10%VDD		
Duty Cycle 占空比	45~55%		
Rise Time/Fall Time 上升沿/下降沿	5ns Max		
Start-up Time 启动时间	7ms Max		
RMS Jitter [12 kHz ~ 20 MHz] 相位抖动	1.5ps Max	1.1ps Max	1ps Max
Supply Current 消耗电流	See Below		
Frequency Aging (at 25°C) 老化率	±3 ppm / year Max		

Programmable Crystal Oscillator YSO690PR



Current Consumption (消耗电流)

Supply Voltage (V)	Power Dissipation				
	1.000~30.000MHz	31.000~75.000MHz	76.000~110.000MHz	111.000~166.000MHz	167.000~200.000MHz
1.8V	18mA Max	19mA Max	20mA Max	20mA Max	20mA Max
2.5V	21mA Max	22mA Max	23mA Max	24mA Max	25mA Max
3.3V	24mA Max	24mA Max	25mA Max	26mA Max	27mA Max

Pin Dimension (脚位尺寸)

Pin	Symbol	Functionality	
1	OE/ST/NC	Output Enable	H: specified frequency output L: output is low. Specified frequency output stop.
		Standby	H: specified frequency output L: output is low. Device goes to sleep mode. Supply current reduces to 400uA(Standby Current).
		No Connect	Pin 1 = VDD or Pin 1 is Open : Specified frequency output. Pin 1 has no function
2	GND	Power	Electrical ground
3	OUT	Output	Oscillator output
4	VDD	Power	Power supply voltage

Pin Assignments

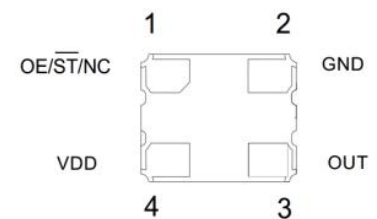

Dimensions and Recommended Land Pattern (外观尺寸及推荐焊盘)

Dimensions (Unit: mm)	Recommended Land Pattern (Unit: mm)
<p>2.0*1.6mm</p>	

Programmable Crystal Oscillator YSO690PR



<p>2.5*2.0mm</p>	
<p>3.2*2.5mm</p>	
<p>5.0*3.2mm</p>	
<p>7.0*5.0mm</p>	

Programmable Crystal Oscillator YSO690PR



Test Circuit (测试电路)

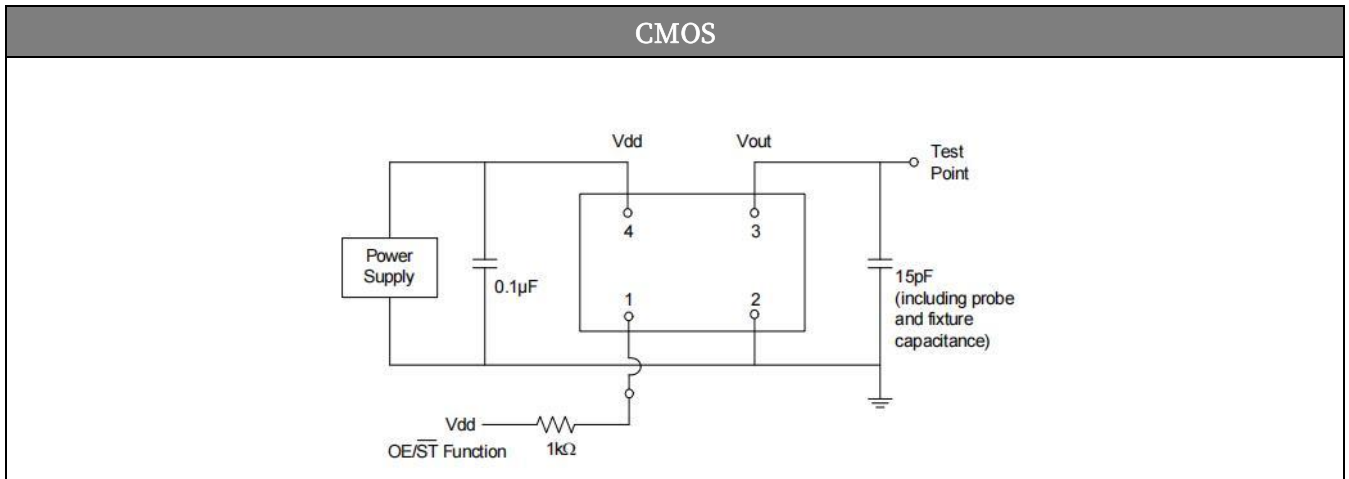

X-ON Electronics

Largest Supplier of Electrical and Electronic Components

Click to view similar products for [Standard Clock Oscillators](#) category:

Click to view products by [Yangxing](#) manufacturer:

Other Similar products are found below :

[F335-25](#) [F535L-33.333](#) [F535L-50](#) [NBXHBA019LN1TAG](#) [SiT1602BI-22-33E-50.000000E](#) [SIT8918AA-11-33S-50.000000G](#) [SM4420TEV-40.0M-T1K](#) [F335-24](#) [F335-40](#) [F535L-10](#) [F535L-12](#) [F535L-24](#) [F535L-27](#) [PE7744DW-100.0M](#) [ASF1-3.686MHZ-N-K-S](#) [ASV-4.000MHZ-LCS-T](#) [XO57CTECNA3M6864](#) [601251](#) [SiT8503AI-18-33E-0.200000X](#) [SIT9122AI2C233E300.000000X](#) [9120AC-2D2-33E212.500000](#) [9102AI-243N25E100.00000](#) [8208AC-82-18E-25.00000](#) [8008AI-72-XXE-24.545454E](#) [8004AC-13-33E-133.33000X](#) [AS-4.9152-16-SMD-TR](#) [ASFL1-48.000MHZ-LC-T](#) [632L3I004M00000](#) [SIT8920AM-31-33E-25.0000](#) [DSC1028DI2-019.2000](#) [9121AC-2C3-25E100.00000](#) [9102AI-233N33E100.00000X](#) [9102AI-233N25E200.00000](#) [9102AI-232H25S125.00000](#) [9102AI-133N25E200.00000](#) [9102AC-283N25E200.00000](#) [9001AC-33-33E1-30.000](#) [8103AC-13-33E-12.00000X](#) [3921AI-2CF-33NZ125.000000](#) [5730-1SF](#) [XUN736000.032768I](#) [ASV-25.000MHZ-ECS-50-T](#) [EC3925ETTTS-100.000M TR](#) [SIT1602BC-83-33E-10.000000Y](#) [8003AI-12-33S-40.00000Y](#) [1602BI-13-33S-19.200000E](#) [8208AI-2F-18E-25.000000X](#) [8103AI-83-33E-33.00000X](#) [8208AI-8F-33E-66.666666X](#) [NX7031E0125.000000](#)