

Differential Oscillator

YSO230LR



Applications

- 10 GB Ethernet,
SONET, SATA, SAS,
Fibre Channel

Features

- Freq range:13.5MHz-200MHz.
- Output LVPECL or LVDS.

- Package Size: 2.5*2.0, 3.2*2.5, 5.0*3.2
7.0*5.0mm.

Specifications

Item/Type	LVPECL		LVDS		Remarks		
	7050/5032	3225/2520	7050/5032	3225/2520			
Output Frequency Range	13.5~200MHZ	13.5~156.25MHZ	13.5~200MHZ	13.5~156.25MHZ			
Supply Voltage	2.5V~3.3V		1.8V, 2.5V~3.3V				
Operating Temperature Range	-40~+85℃, or specify						
Storage Temperature Range	-55~+125℃						
Total Stability	±50ppm						
Current Consumption	80mA Max	50mA Max	60mA Max	40mA Max	OE=Vcc, LVPECL=(50)Ω or LVDS=(100)Ω		
Disable Current	10uA Max				OE=GND		
Output Voltage (LVPECL)	VOH=Vcc-1.03 Min		--		DC characteristics		
	VOL=Vcc-1.6 Max		--				
Output Voltage (LVDS)	--		VOD= 247~454mV		VOD1, VOD2		
	--		dVOD=50mV Max.		dVOD= VOD1-VOD2		
	--		VOS= 1.125~1.375V		VOS1, VOS2		
	--		dVOS=50mV Max.		dVOS= VOD1-VOD2		
Output Load Condition	L_PECL=50Ω		--		Terminated to Vcc-2.0V		
	--		L_LVDS=100Ω		Connected between OUT to OUT		
Input Voltage	VIH=70% VccMin, VIL=30%Vcc Max				OE terminal		
Output Symmetry	45~55%						
Rise Time/Fall Time	0.8nS Max				LVPECL: Between 20% and 80% of (VOH-VOL), LVDS: Between 20% and 80% Differential Output peak to peak voltage		
Start-up time	10mS				Time at minimum supply voltage to be 0 s		
Aging	±3ppm				25℃ First year, Vcc=2.5V, 3.3V		
Phase Jitter(12KHZ~20MHZ)	100MHZ	125MHZ	148.5MHZ	156.25MHZ	180MHZ	200MHZ	
	0.3ps Typ.		0.1ps Typ.				

Pin Dimension

Pin	#1	#2	#3	#4	#5	#6
FUNCTION	OE	NC	GND	OUT+	OUT-	VDD

Notes: To maintain stable operation provide a 0.01uF to 0.1uF by-pass capacitor at a location as near as possible to the power source terminal of the crystal product (between Vcc-GND).

Top View

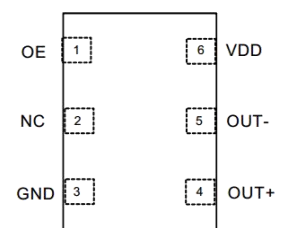

Figure 1. Pin Assignments

YSO230LR

Dimensions and Patterns [unit:mm]

Package Size – Dimensions (Unit: mm)	Recommended Land Pattern (Unit: mm)
<p>2.5*2.0mm</p>	
<p>3.2*2.5mm</p>	
<p>5.0*3.2mm</p>	
<p>7.0*5.0mm</p>	

Notes:

1.A capacitor of value 0.01uf~0.1uf or higher between Vdd and GND is required.

YSO230LR

Reflow Soldering Profile

Pre Heating Temperature $T_{p1} \sim T_{p2} = +170\text{ }^{\circ}\text{C}$

Heating Temperature

$T_{Mlt} = +220\text{ }^{\circ}\text{C}$

Peek Temperature

$T_{Max.} = +260\text{ }^{\circ}\text{C}$

Point of measuring

In case of Solder ability Terminal.

In case of Resistance to soldering heat Surface.

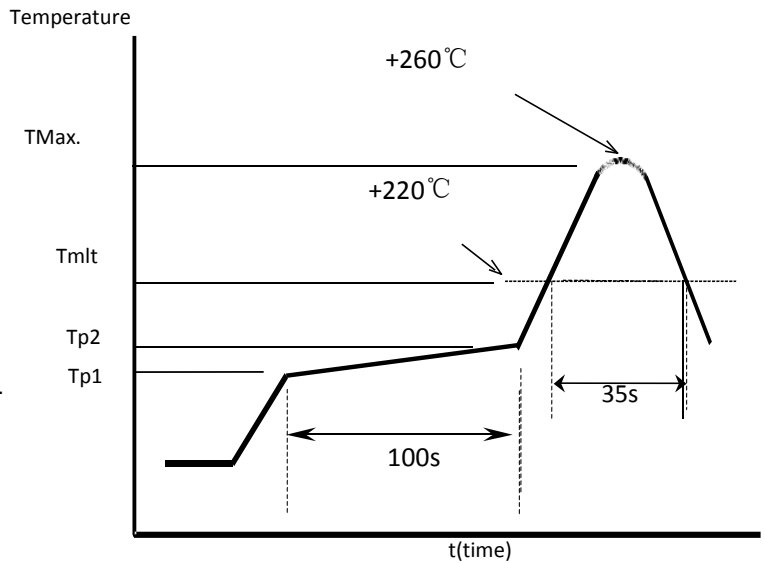

Test Circuit

LVDS

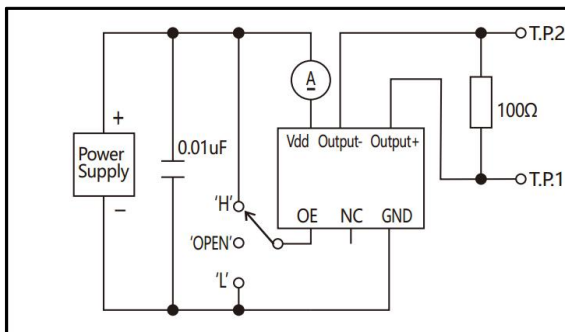

LVPECL

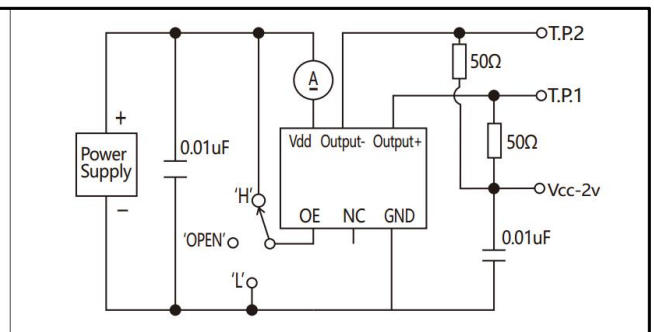

Taping Specification(Unit: mm)

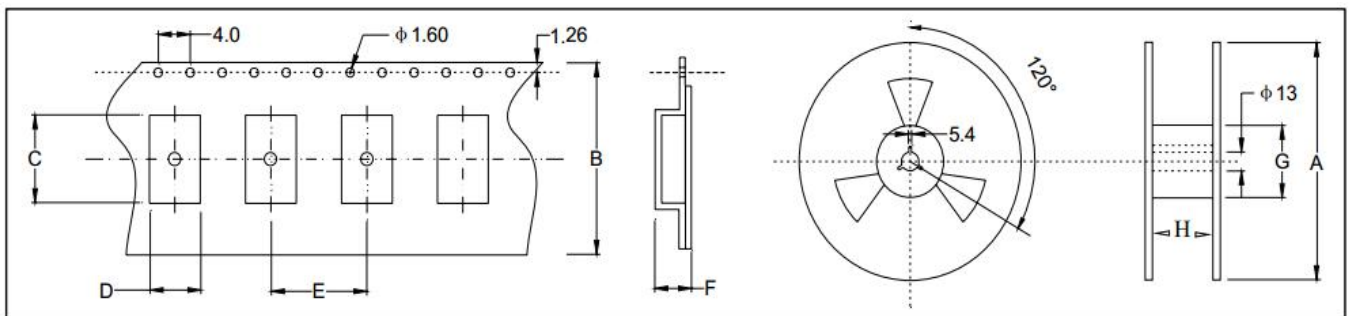

Size(OSC)	A	B	C	D	E	F	G	H
SMD-7050	180±2.0	16.0±0.3	7.50±0.1	5.50±0.1	8.0±0.1	2.00±0.1	61.0±1.0	16.0±1.0
SMD-5032	180±2.0	12.0±0.3	5.40±0.1	3.60±0.1	8.0±0.1	1.70±0.1	61.0±1.0	12.0±1.0
SMD-3225	180±2.0	8.0±0.3	3.40±0.1	2.70±0.1	4.0±0.1	1.50±0.1	61.0±1.0	8.0±1.0
SMD-2520	180±2.0	8.0±0.3	2.90±0.1	2.40±0.1	4.0±0.1	1.20±0.1	61.0±1.0	8.0±1.0

X-ON Electronics

Largest Supplier of Electrical and Electronic Components

Click to view similar products for [Standard Clock Oscillators](#) category:

Click to view products by [Yangxing](#) manufacturer:

Other Similar products are found below :

[601252](#) [F335-25](#) [F535L-33.333](#) [F535L-50](#) [NBXHBA019LN1TAG](#) [SiT1602BI-22-33E-50.000000E](#) [SiT8209AI-32-33E-125.000000](#)
[SIT8918AA-11-33S-50.000000G](#) [SM4420TEV-40.0M-T1K](#) [F335-24](#) [F335-40](#) [F535L-10](#) [F535L-12](#) [F535L-24](#) [F535L-27](#) [PE7744DW-](#)
[100.0M](#) [ASF1-3.686MHZ-N-K-S](#) [ASV-4.000MHZ-LCS-T](#) [XLH735025.000JU4I8](#) [XLP725125.000JU6I8](#) [XO57CTECNA3M6864](#) [601251](#)
[SiT8503AI-18-33E-0.200000X](#) [SIT8918AA-11-33S-16.000000G](#) [SIT9122AI2C233E300.000000X](#) [XO37CTECNA20M](#) [9120AC-2D2-](#)
[33E212.500000](#) [9102AI-243N25E100.000000](#) [8208AC-82-18E-25.000000](#) [8008AI-72-XXE-24.545454E](#) [8004AC-13-33E-133.33000X](#) [AS-](#)
[4.9152-16-SMD-TR](#) [ASFL1-48.000MHZ-LC-T](#) [632L3I004M00000](#) [SIT8920AM-31-33E-25.0000](#) [DSC1028DI2-019.2000](#) [9121AC-2C3-](#)
[25E100.000000](#) [9102AI-233N33E100.00000X](#) [9102AI-233N25E200.000000](#) [9102AI-232H25S125.000000](#) [9102AI-133N25E200.000000](#) [9102AC-](#)
[283N25E200.000000](#) [9001AC-33-33E1-30.0000](#) [8103AC-13-33E-12.00000X](#) [3921AI-2CF-33NZ125.000000](#) [5730-1SF](#) [XUN736000.032768I](#)
[EC3925ETTTTS-100.000M TR](#) [SIT1602BC-83-33E-10.000000Y](#) [8003AI-12-33S-40.00000Y](#)