

Differential Oscillator

YSO230LR



Applications

- Optical modules
- Accelerator Card

Features

- Frequency Range: 13.5MHz ~ 200MHz
- Package Size: 2.5*2.0, 3.2*2.5, 5.0*3.2
- Output: LVPECL, HCSL or LVDS
- 7.0*5.0mm

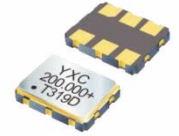

Specifications (规格参数)

Item/Type	LVPECL		LVDS		HCSL		Remarks
	7050/5032	3225/2520	7050/5032	3225/2520	7050/5032	3225/2520	
Output Frequency Range 额定频率范围	13.5 ~ 200 MHz	13.5 ~ 156.25 MHz	13.5 ~ 200 MHz	13.5 ~ 156.25 MHz	13.5 ~ 200 MHz	13.5 ~ 156.25 MHz	
Supply Voltage 电源电压	2.5V ~ 3.3V		1.8V, 2.5V ~ 3.3V		2.5V ~ 3.3V		
Operating Temperature Range 工作温度	-40~+85°C, or specify						
Storage Temperature Range 储存温度	-55~+125°C						
Total Stability 频率偏差	±25ppm, ±50ppm, or specify						Inclusive of Initial tolerance at 25°C, 1st year aging at 25°C, and variations over operating temperature
Current Consumption 消耗电流	80mA Max	50mA Max	60mA Max	40mA Max	50mA Max		OE=VDD, LVPECL=(50)Ω, HCSL=(50)Ω or LVDS=(100)Ω
Disable Current 禁用电流	10uA Max						OE=GND
Output Voltage (LVPECL) 输出电压 (LVPECL)	VOH=VDD-1.03 Min		--		--		DC characteristics
	VOL=VDD-1.6 Max		--		--		
Output Voltage (LVDS) 输出电压 (LVDS)	--		VOD= 350mV		--		DC characteristics
	--		dVOD=50mV Max		--	dVOD= VOD1-VOD2	
	--		VOS= 1.125~1.375V		--	VOS1, VOS2	
	--		dVOS=50mV Max		--	dVOS= VOD1-VOD2	
Output Voltage (HCSL) 输出电压 (HCSL)	--		--		VOH= 0.9V Max		DC characteristics
	--		--		VOL= -0.15V Min		
Output Load Condition 输出负载	L_PECL=50Ω		--		--		Terminated to VDD-2.0V
	--		L_LVDS=100Ω		--		Connected between OUT to OUT
	--		--		L_HCSL=50Ω		--
Input Voltage 输入电压	VIH=70% VDD Min, VIL=30%VDD Max						OE terminal
Duty Cycle 占空比	45~55%						
Rise Time/Fall Time 上升沿/下降沿	0.8nS Max			0.7nS Max			LVPECL: Between 20% and 80% of (VOH-VOL), LVDS: Between 20% and 80% Differential Output peak to peak voltage

Differential Oscillator

YSO230LR



Item/Type	LVPECL		LVDS		HCSL		Remarks
	7050/5032	3225/2520	7050/5032	3225/2520	7050/5032	3225/2520	
Start-up time 启动时间	10mS						Time at minimum supply voltage to be 0 s
Aging 老化率	±3ppm						25°C First year, VDD=2.5V, 3.3V
RMS Jitter [12 kHz ~ 20 MHz] 相位抖动	100MHZ	125MHZ	148.5MHZ	156.25MHZ	180MHZ	200MHZ	
	0.3ps Typ.	0.1ps Typ.					

Pin Dimension (脚位尺寸)

Pin	#1	#2	#3	#4	#5	#6
FUNCTION	OE	NC	GND	OUT+	OUT-	VDD

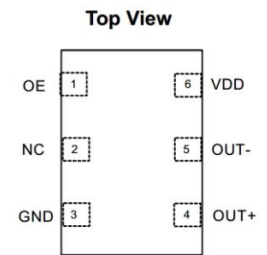

Figure 1. Pin Assignments

Notes: To maintain stable operation provide a 0.01uF to 0.1uF by-pass capacitor at a location as near as possible to the power source terminal of the crystal product (between VDD-GND).

Dimensions and Recommended Land Pattern (外观尺寸及推荐焊盘)

Dimensions (Unit: mm)	Recommended Land Pattern (Unit: mm)
<p>2.5*2.0mm</p>	
<p>3.2*2.5mm</p>	

Differential Oscillator

YSO230LR

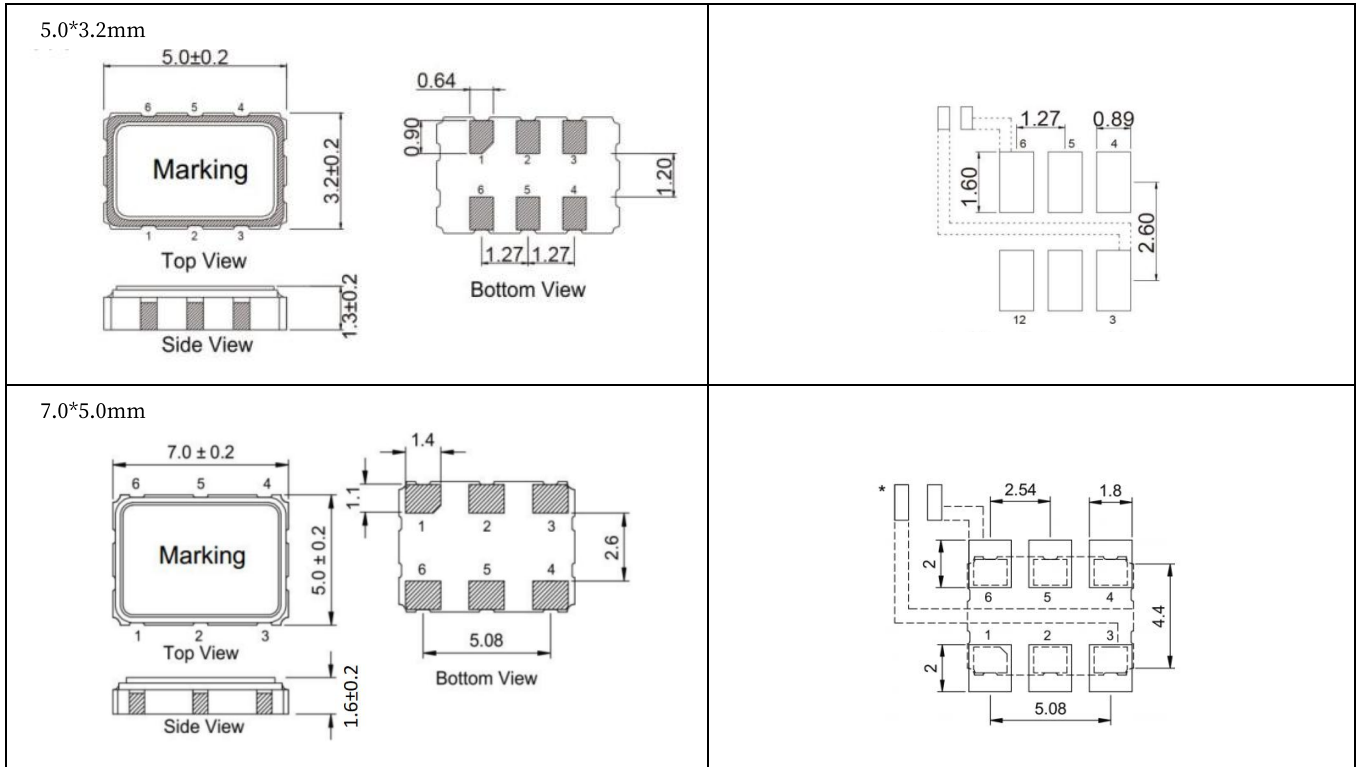

Notes:

1. A capacitor of value 0.01uF~0.1uF or higher between VDD and GND is required.

Test Circuit (测试电路)

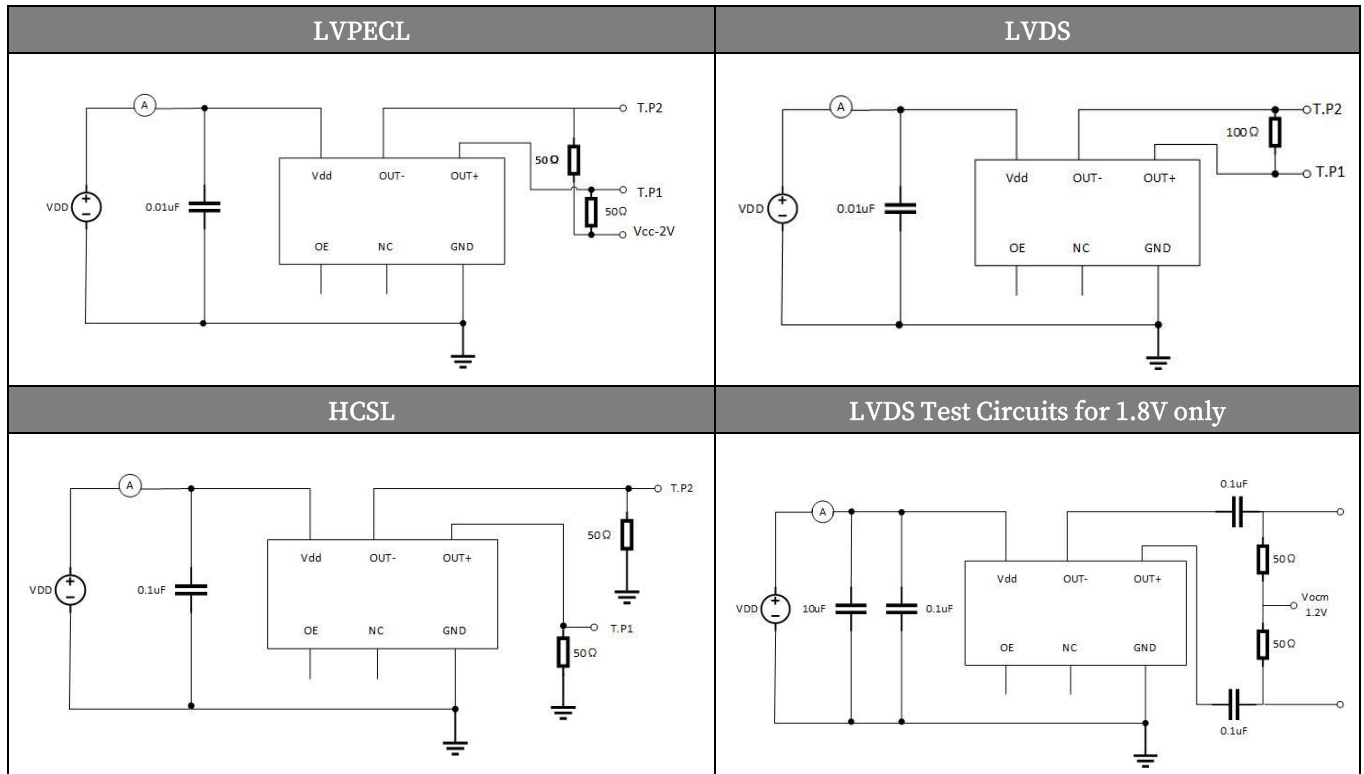

X-ON Electronics

Largest Supplier of Electrical and Electronic Components

Click to view similar products for [Standard Clock Oscillators](#) category:

Click to view products by [Yangxing](#) manufacturer:

Other Similar products are found below :

[F335-25](#) [F535L-33.333](#) [F535L-50](#) [NBXHBA019LN1TAG](#) [SiT1602BI-22-33E-50.000000E](#) [SIT8918AA-11-33S-50.000000G](#) [SM4420TEV-40.0M-T1K](#) [F335-24](#) [F335-40](#) [F535L-10](#) [F535L-12](#) [F535L-24](#) [F535L-27](#) [PE7744DW-100.0M](#) [ASF1-3.686MHZ-N-K-S](#) [ASV-4.000MHZ-LCS-T](#) [XO57CTECNA3M6864](#) [601251](#) [SiT8503AI-18-33E-0.200000X](#) [SIT9122AI2C233E300.000000X](#) [9120AC-2D2-33E212.500000](#) [9102AI-243N25E100.00000](#) [8208AC-82-18E-25.00000](#) [8008AI-72-XXE-24.545454E](#) [8004AC-13-33E-133.33000X](#) [AS-4.9152-16-SMD-TR](#) [ASFL1-48.000MHZ-LC-T](#) [632L3I004M00000](#) [SIT8920AM-31-33E-25.0000](#) [DSC1028DI2-019.2000](#) [9121AC-2C3-25E100.00000](#) [9102AI-233N33E100.00000X](#) [9102AI-233N25E200.00000](#) [9102AI-232H25S125.00000](#) [9102AI-133N25E200.00000](#) [9102AC-283N25E200.00000](#) [9001AC-33-33E1-30.000](#) [8103AC-13-33E-12.00000X](#) [3921AI-2CF-33NZ125.000000](#) [5730-1SF](#) [XUN736000.032768I](#) [ASV-25.000MHZ-ECS-50-T](#) [EC3925ETTTS-100.000M TR](#) [SIT1602BC-83-33E-10.000000Y](#) [8003AI-12-33S-40.00000Y](#) [1602BI-13-33S-19.200000E](#) [8208AI-2F-18E-25.000000X](#) [8103AI-83-33E-33.00000X](#) [8208AI-8F-33E-66.666666X](#) [NX7031E0125.000000](#)