

PROGRAMMABLE CRYSTAL OSCILLATOR



YSO691ER Low Jitter

Applications

- Any frequency

Features

- One time programmable
- PLL circuit provides wide frequency range application (1-200MHz)
- Low jitter design with new developed IC
- Package Size: 5.0*3.2, 7.0*5.0mm



Specifications

Parameter	1.8V	2.5V	3.3V
Frequency Range	1MHz to 125MHz	1MHz to 200MHz	1MHz to 200MHz
Supply Voltage Variation (Vdd)10%	1.62V~1.98V	2.25V~2.75V	2.97V~3.63V
Standby Current	400uA		
Frequency Tolerance	±20ppm,±25ppm,±50ppm,or specify		
Output Load	15pF		
Operating Temperature Range	-40~+85℃,or specify		
Storage Temperature Range	-55~+150℃		
Voltage Vol (Max.) / Vol (Min.)	VOH = 90%Vdd/VOL = 10%Vdd		
Duty Cycle	45~55%		
Period Jitter (@12K-20Mhz)	1.8V<1.5ps 2.5V<1.1ps 3.3V< 1ps		
Start-up Time	7ms Max.		
Supply Current	See Below		
Frequency Aging (at 25℃)	±3 ppm / year Max.		

Pin Dimension

Pin	Symbol	Functionality	
1	OE/ST/NC	Output Enable	H: specified frequency output L: output is low. Specified frequency output stop.
		Standby	H: specified frequency output L: output is low. Device goes to sleep mode. Supply current reduces to 400uA(Standby Current).
		No Connect	Pin 1 = VDD or Pin 1 is Open : Specified frequency output.Pin 1 has no function
2	GNG	Power	Electrical ground
3	OUT	Output	Oscillator output
4	VDD	Power	Power supply voltage

Pin Assignments

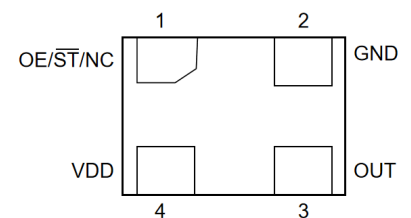

Current Consumption

Supply Voltage (V)	Power Dissipation				
	1.000~30.000MHZ	31.000~75.000MHZ	76.000~110.000MHZ	111.000~166.000MHZ	167.000~200.000MHZ
1.8V	18mA max	19mA max	20mA max	20mA max	20mA max
2.5V	21mA max	22mA max	23mA max	24mA max	25mA max
3.3V	23mA max	24mA max	25mA max	26mA max	27mA max

PROGRAMMABLE CRYSTAL OSCILLATOR



YSO691ER Low Jitter

Dimensions and Patterns [unit:mm]

Package Size – Dimensions (Unit: mm)	Recommended Land Pattern (Unit: mm)
<p>7.0*5.0mm</p>	
<p>5.0*3.2mm</p>	

Reflow Soldering Profile

- Pre Heating Temperature
- Tp1 ~ Tp2 = + 170 °C
- Heating Temperature
- TMit = + 220 °C
- Peek Temperature
- TMax. = + 260 °C

Point of measuring
In case of Solder ability Terminal.
In case of Resistance to soldering heat Surface.

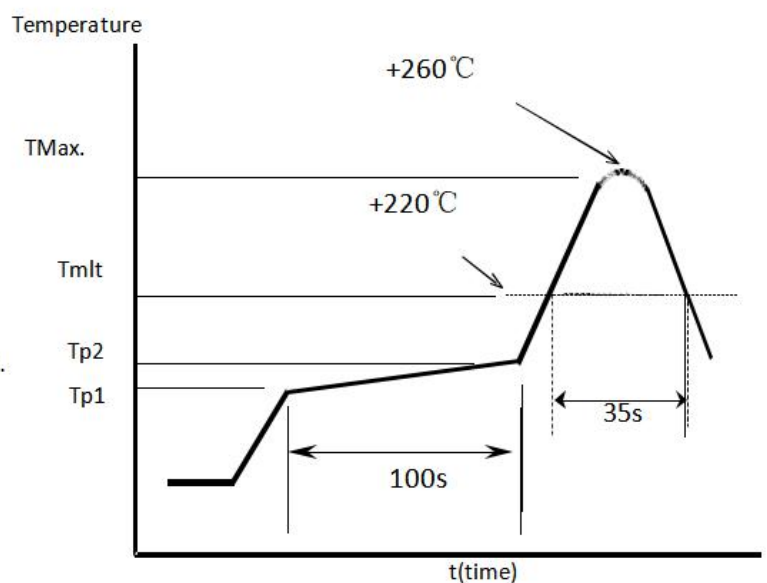

PROGRAMMABLE CRYSTAL OSCILLATOR

YSO691ER Low Jitter



Test Circuit

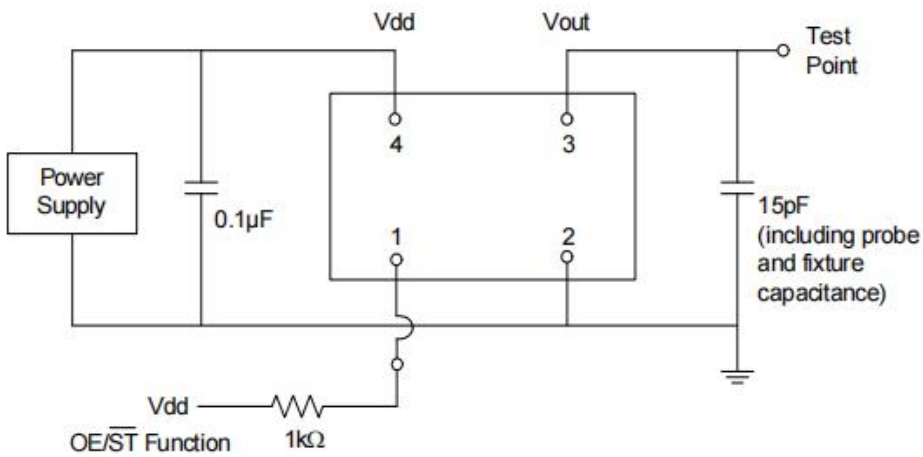

Taping Specification (Unit: mm)

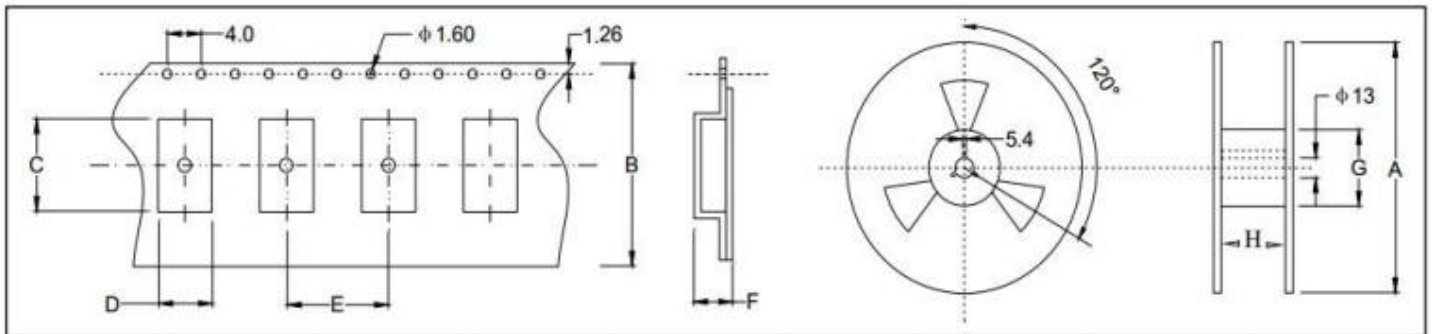

Size(OSC)	A	B	C	D	E	F	G	H
SMD-7050	180±2.0	16.0±0.3	7.90±0.1	5.60±0.1	8.0±0.1	1.90±0.1	61.0±1.0	16.0±1.0
SMD-5032	180±2.0	12.0±0.3	5.60±0.1	3.60±0.1	8.0±0.1	1.90±0.1	61.0±1.0	12.0±1.0

X-ON Electronics

Largest Supplier of Electrical and Electronic Components

Click to view similar products for [Standard Clock Oscillators](#) category:

Click to view products by [Yangxing](#) manufacturer:

Other Similar products are found below :

[601252](#) [F335-25](#) [F535L-33.333](#) [F535L-50](#) [NBXHBA019LN1TAG](#) [SiT1602BI-22-33E-50.000000E](#) [SiT8209AI-32-33E-125.000000](#)
[SIT8918AA-11-33S-50.000000G](#) [SM4420TEV-40.0M-T1K](#) [F335-24](#) [F335-40](#) [F535L-10](#) [F535L-12](#) [F535L-24](#) [F535L-27](#) [PE7744DW-](#)
[100.0M](#) [ASF1-3.686MHZ-N-K-S](#) [ASV-4.000MHZ-LCS-T](#) [XLH735025.000JU4I8](#) [XLP725125.000JU6I8](#) [XO57CTECNA3M6864](#) [601251](#)
[SiT8503AI-18-33E-0.200000X](#) [SIT8918AA-11-33S-16.000000G](#) [SIT9122AI2C233E300.000000X](#) [XO37CTECNA20M](#) [9120AC-2D2-](#)
[33E212.500000](#) [9102AI-243N25E100.000000](#) [8208AC-82-18E-25.000000](#) [8008AI-72-XXE-24.545454E](#) [8004AC-13-33E-133.33000X](#) [AS-](#)
[4.9152-16-SMD-TR](#) [ASFL1-48.000MHZ-LC-T](#) [632L3I004M00000](#) [SIT8920AM-31-33E-25.0000](#) [DSC1028DI2-019.2000](#) [9121AC-2C3-](#)
[25E100.000000](#) [9102AI-233N33E100.00000X](#) [9102AI-233N25E200.000000](#) [9102AI-232H25S125.000000](#) [9102AI-133N25E200.000000](#) [9102AC-](#)
[283N25E200.000000](#) [9001AC-33-33E1-30.0000](#) [8103AC-13-33E-12.00000X](#) [3921AI-2CF-33NZ125.000000](#) [5730-1SF](#) [XUN736000.032768I](#)
[EC3925ETTTTS-100.000M TR](#) [SIT1602BC-83-33E-10.000000Y](#) [8003AI-12-33S-40.00000Y](#)