

Crystal Oscillator

YSO110TR Wide Voltage



Applications

- Consumer Electronics
- Industrial Control
- IOT

Features

- Frequency range: 1MHz-54MHz..
- Ultra Small SMD seam sealed crystal oscillator units.
- Package Size: 1.6*1.2, 2.0*1.6, 2.5*2.0, 3.2*2.5, 5.0*3.2, 7.0*5.0mm

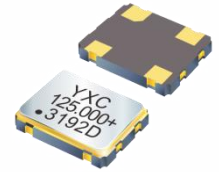

Specifications (规格参数)

Item	Symbol	Specifications
Frequency Range (额定频率范围)	f _o	1MHz to 54MHz, or specify
Supply Voltage (电源电压)	V _{cc}	1.8V~3.3V
Output Type (输出方式)	-	CMOS
Frequency Tolerance (频率偏差) (at 25°C)	f _{tol}	±10ppm, ±20ppm, or specify
Output Load (输出负载)	L _{cmos}	15pF
Operating Temperature (工作温度)	T _{use}	-40~+85°C, or specify
Storage Temperature (储存温度)	T _{stg}	-55~+125°C
Frequency Versus Temperature Characteristics (频率-温度特性)	f _{tem}	± 20ppm, ± 30ppm, ± 50ppm, or specify
Duty Cycle (占空比)	SYM	45~55%
Start-up Time (启动时间)	t _{str}	3ms Max.
Rise Time/Fall Time (上升沿/下降沿)	tr/tf	4ns Max
Phase Jitter [12 kHz ~ 20 MHz] (相位抖动)	tpj	0.7ps max
Frequency Aging (老化) (at 25°C)	f _{age}	±3ppm/year Max.

Current Consumption (消耗电流)

Power Dissipation V _{cc} =1.8~3.3V 15pF only				
Supply Voltage (V)	1.000~40.000MHZ		41.000~54.000MHZ	
	7050/5032/3225	2520/2016/1612	7050/5032/3225/2520	2016/1612
1.8V	4mA max	4mA max	9mA max	10mA max
2.5V	4.5mA max		10mA max	
3.3V	5mA max		12mA max	

Pin Dimension (脚位尺寸)

Pin	#1	#2	#3	#4
FUNCTION	Tri-state	GND	OUTPUT	VDD

Pin Assignments

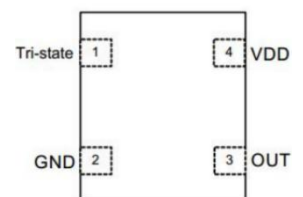

*The picture on the right is only for PIN function description.

Crystal Oscillator

YSO110TR Wide Voltage



Dimensions and Recommended land pattern (外观尺寸及推荐焊盘)

Package Size - Dimensions(Unit:mm)	Recommended Land Pattern(Unit:mm)
<p>1.6*1.2mm</p>	
<p>2.0*1.6mm</p>	
<p>2.5*2.0mm</p>	
<p>3.2*2.5mm</p>	

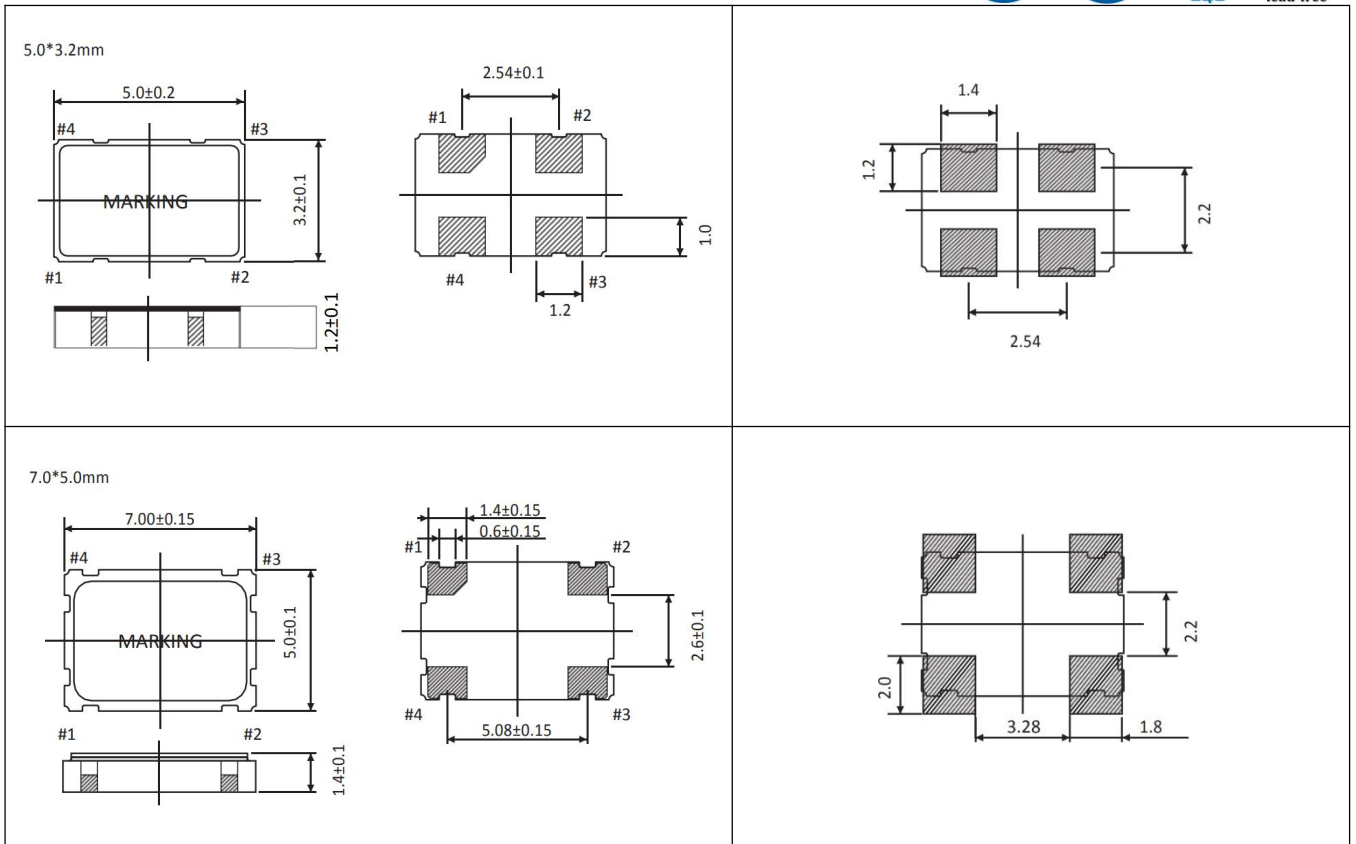

Notes:

1. A capacitor value-0.01uf~0.1uf or higher between Vdd and GND is required.

Test Circuit (测试电路)

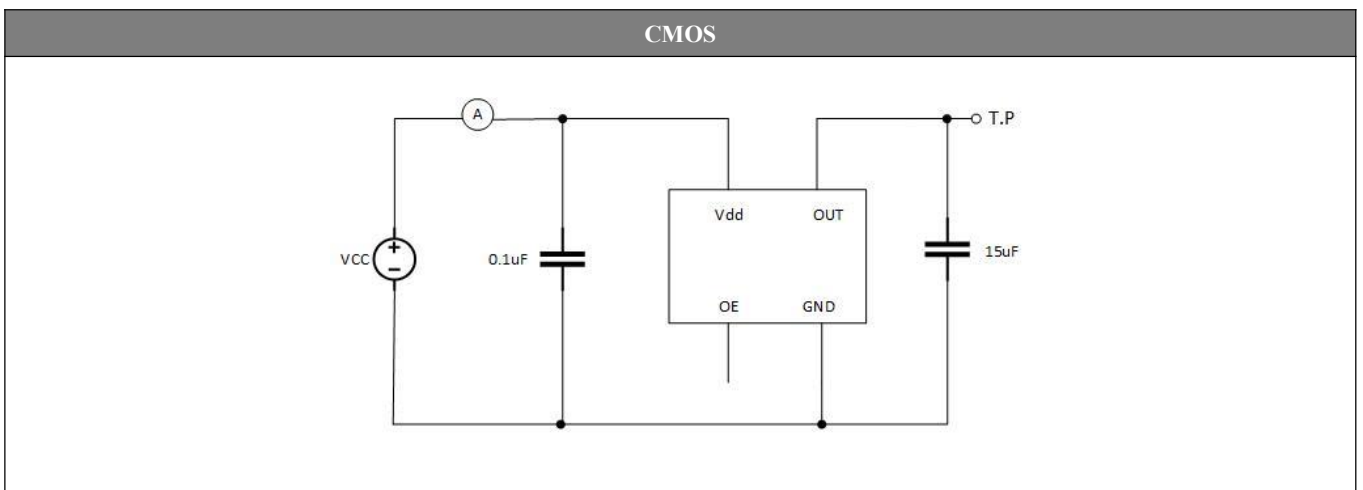

X-ON Electronics

Largest Supplier of Electrical and Electronic Components

Click to view similar products for [Standard Clock Oscillators](#) category:

Click to view products by [Yangxing](#) manufacturer:

Other Similar products are found below :

[601252](#) [F335-25](#) [F535L-33.333](#) [F535L-50](#) [NBXHBA019LN1TAG](#) [SiT1602BI-22-33E-50.000000E](#) [SiT8209AI-32-33E-125.000000](#)
[SIT8918AA-11-33S-50.000000G](#) [SM4420TEV-40.0M-T1K](#) [F335-24](#) [F335-40](#) [F535L-10](#) [F535L-12](#) [F535L-24](#) [F535L-27](#) [PE7744DW-](#)
[100.0M](#) [ASF1-3.686MHZ-N-K-S](#) [ASV-4.000MHZ-LCS-T](#) [XLH735025.000JU4I8](#) [XLP725125.000JU6I8](#) [XO57CTECNA3M6864](#) [601251](#)
[SiT8503AI-18-33E-0.200000X](#) [SIT8918AA-11-33S-16.000000G](#) [SIT9122AI2C233E300.000000X](#) [XO37CTECNA20M](#) [9120AC-2D2-](#)
[33E212.500000](#) [9102AI-243N25E100.000000](#) [8208AC-82-18E-25.000000](#) [8008AI-72-XXE-24.545454E](#) [8004AC-13-33E-133.33000X](#) [AS-](#)
[4.9152-16-SMD-TR](#) [ASFL1-48.000MHZ-LC-T](#) [632L3I004M00000](#) [SIT8920AM-31-33E-25.0000](#) [DSC1028DI2-019.2000](#) [9121AC-2C3-](#)
[25E100.000000](#) [9102AI-233N33E100.00000X](#) [9102AI-233N25E200.000000](#) [9102AI-232H25S125.000000](#) [9102AI-133N25E200.000000](#) [9102AC-](#)
[283N25E200.000000](#) [9001AC-33-33E1-30.0000](#) [8103AC-13-33E-12.00000X](#) [3921AI-2CF-33NZ125.000000](#) [5730-1SF](#) [XUN736000.032768I](#)
[EC3925ETTTTS-100.000M TR](#) [SIT1602BC-83-33E-10.000000Y](#) [8003AI-12-33S-40.00000Y](#)