

CRYSTAL OSCILLATOR

YSO110TR *Wide Voltage*



Applications

- Consumer Electronics
- Industrial Control
- IOT

Features

- Frequency range:1MHz-54MHz
- Ultra Small SMD seam sealed crystal oscillator units.
- Package Size: 1.6*1.2 , 2.0*1.6
2.5*2.0 , 3.2*2.5 , 5.0*3.2 , 7.0*5.0mm

Specifications

Frequency Range	1MHz to 54MHz,or specify
Parameter	1.8V~3.3V
Output Type	CMOS
Frequency Tolerance(at 25°C)	±10ppm,±20ppm,or specify
Output Load	15pF
Operating Temperature Range	-40~+85°C,-40~+125°C,or specify
Storage Temperature Range	-55~+125°C
Frequency Versus Temperature Characteristics	± 20ppm, ± 30ppm, ± 50ppm, or specify
Voltage Vol (Max.) / Vol (Min.)	VOH = 90%Vdd/VOL = 10%Vdd
Duty Cycle	45~55%
Start-up Time	3ms Max.
Rise Time/Fall Time	4nS Max
Supply Current	See Below
Frequency Aging (at 25°C)	±3 ppm / year Max.

Current Consumption

Power Dissipation Vcc=1.8~3.3V 15pF only				
Supply Voltage (V)	1.000~40.000MHZ		41.000~54.000MHZ	
	7050/5032/3225	2520/2016/1612	7050/5032/3225/2520	2016/1612
1.8V	4mA max	4mA max	9mA max	10mA max
2.5V	4.5mA max		10mA max	
3.3V	5mA max		12mA max	

Pin Dimension

Pin	#1	#2	#3	#4
FUNCTION	Tri-state	GND	OUTPUT	VDD

Pin Assignments



CRYSTAL OSCILLATOR

YSO110TR *Wide Voltage*



Dimensions and Patterns [unit:mm]

Package Size – Dimensions (Unit: mm)	Recommended Land Pattern (Unit: mm)
<p>1.6*1.2mm</p>	
<p>2.0*1.6mm</p>	
<p>2.5*2.0mm</p>	
<p>3.2*2.5mm</p>	

CRYSTAL OSCILLATOR

YSO110TR Wide Voltage



<p>5.0*3.2mm</p>	
<p>7.0*5.0mm</p>	
<p>Notes: 1.A capacitor of value 0.01uf~0.1uf or higher between Vdd and GND is required.</p>	

Reflow Soldering Profile

Pre Heating Temperature

Tp1 ~ Tp2 = + 170 °C

Heating Temperature

TMI = + 220 °C

Peek Temperature

TMax. = + 260 °C

Point of measuring

In case of Solder ability Terminal.

In case of Resistance to soldering heat Surface.

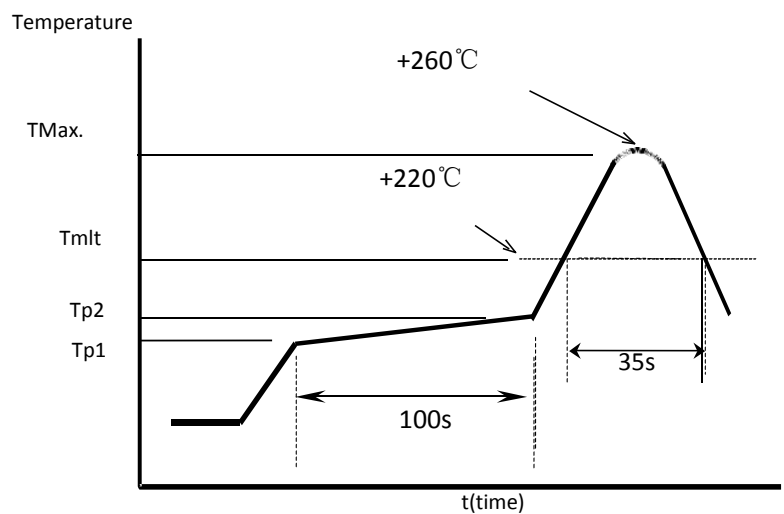

CRYSTAL OSCILLATOR

YSO110TR *Wide Voltage*



Test Circuit



Taping Specification(Unit: mm)



Size(OSC)	A	B	C	D	E	F	G	H
SMD-7050	180±2.0	16.0±0.3	7.50±0.1	5.50±0.1	8.0±0.1	2.00±0.1	61.0±1.0	16.0±1.0
SMD-5032	180±2.0	12.0±0.3	5.40±0.1	3.60±0.1	8.0±0.1	1.70±0.1	61.0±1.0	12.0±1.0
SMD-3225	180±2.0	8.0±0.3	3.40±0.1	2.70±0.1	4.0±0.1	1.50±0.1	61.0±1.0	8.0±1.0
SMD-2520	180±2.0	8.0±0.3	2.90±0.1	2.40±0.1	4.0±0.1	1.20±0.1	61.0±1.0	8.0±1.0
SMD-2016	180±2.0	8.0±0.3	2.30±0.1	1.90±0.1	4.0±0.1	0.95±0.1	61.0±1.0	8.0±1.0
SMD-1612	180±2.0	8.0±0.3	1.80±0.1	1.40±0.1	4.0±0.1	0.80±0.1	61.0±1.0	8.0±1.0

X-ON Electronics

Largest Supplier of Electrical and Electronic Components

Click to view similar products for [Standard Clock Oscillators](#) category:

Click to view products by [Yangxing](#) manufacturer:

Other Similar products are found below :

[601252](#) [F335-25](#) [F535L-33.333](#) [F535L-50](#) [NBXHBA019LN1TAG](#) [SiT1602BI-22-33E-50.000000E](#) [SiT8209AI-32-33E-125.000000](#)
[SIT8918AA-11-33S-50.000000G](#) [SM4420TEV-40.0M-T1K](#) [F335-24](#) [F335-40](#) [F535L-10](#) [F535L-12](#) [F535L-24](#) [F535L-27](#) [PE7744DW-](#)
[100.0M](#) [ASF1-3.686MHZ-N-K-S](#) [ASV-4.000MHZ-LCS-T](#) [XLH735025.000JU4I8](#) [XLP725125.000JU6I8](#) [XO57CTECNA3M6864](#) [601251](#)
[SiT8503AI-18-33E-0.200000X](#) [SIT8918AA-11-33S-16.000000G](#) [SIT9122AI2C233E300.000000X](#) [XO37CTECNA20M](#) [9120AC-2D2-](#)
[33E212.500000](#) [9102AI-243N25E100.000000](#) [8208AC-82-18E-25.000000](#) [8008AI-72-XXE-24.545454E](#) [8004AC-13-33E-133.33000X](#) [AS-](#)
[4.9152-16-SMD-TR](#) [ASFL1-48.000MHZ-LC-T](#) [632L3I004M000000](#) [SIT8920AM-31-33E-25.000000](#) [DSC1028DI2-019.2000](#) [9121AC-2C3-](#)
[25E100.000000](#) [9102AI-233N33E100.000000X](#) [9102AI-233N25E200.000000](#) [9102AI-232H25S125.000000](#) [9102AI-133N25E200.000000](#) [9102AC-](#)
[283N25E200.000000](#) [9001AC-33-33E1-30.000000](#) [8103AC-13-33E-12.000000X](#) [3921AI-2CF-33NZ125.000000](#) [5730-1SF](#) [XUN736000.032768I](#)
[EC3925ETTTTS-100.000M TR](#) [SIT1602BC-83-33E-10.000000Y](#) [8003AI-12-33S-40.000000Y](#)