

YESC YESC KAIZEN

YAZAKI
ENGINEERING
STANDARD
CONNECTORS

CLICK ON YOUR SELECTION:

YESC (SEALED AND UNSEALED)
YESC KAIZEN (NEW UNSEALED)
NAVIGATION TIPS

GO

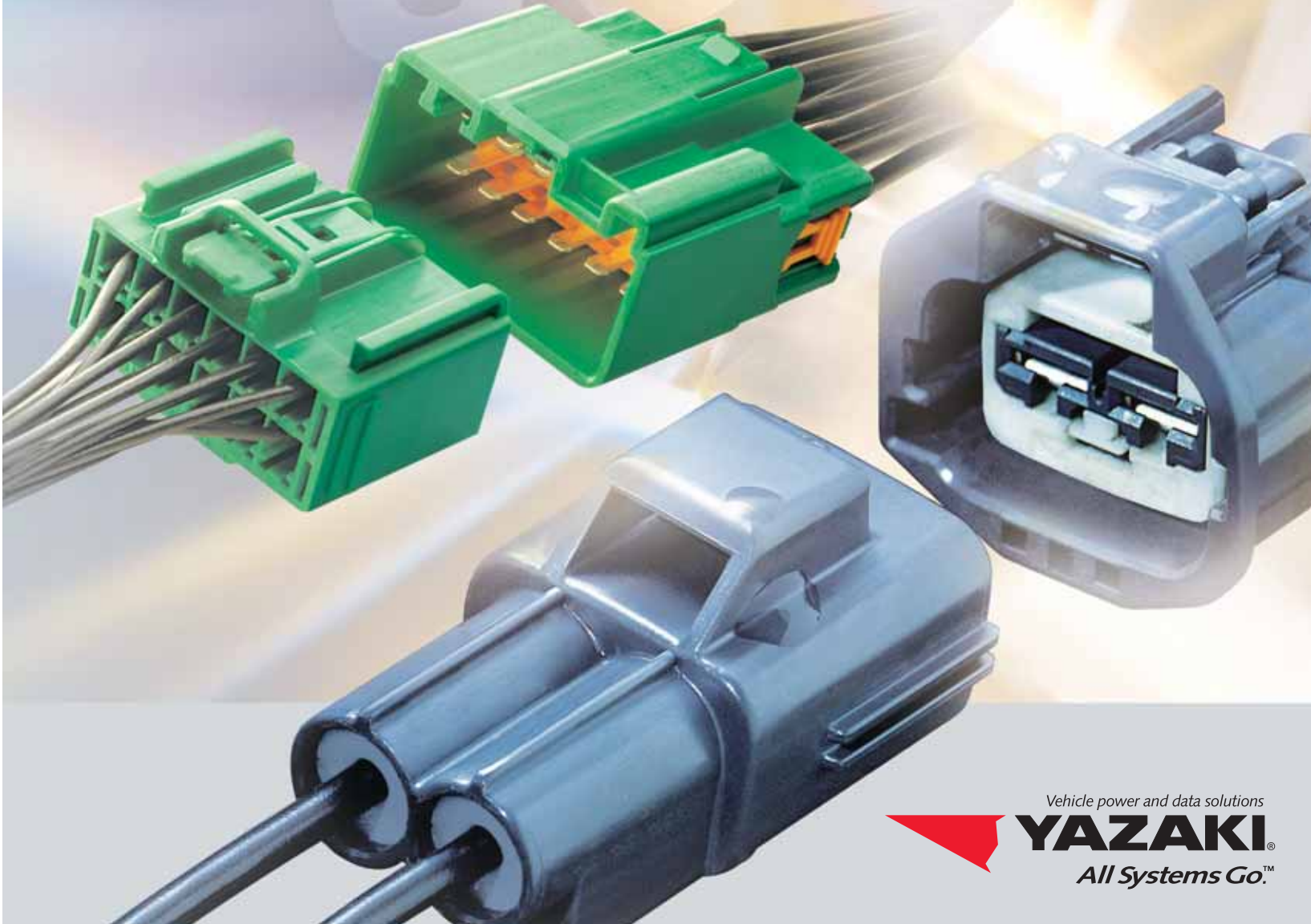

Vehicle power and data solutions
YAZAKI
All Systems Go.™

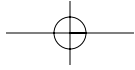

YESC

YAZAKI
ENGINEERING
STANDARD
CONNECTORS

GO

YESC KAIZEN

NAVIGATION TIPS

There are primarily three ways to navigate the interactive Yazaki Connector Catalog.

1. **SEARCH FUNCTION** — *Navigate By Part Number Or Keyword*
2. **DOCUMENT LINKS** — *Navigate To Catalog Menus*
3. **PAGE-ADVANCE BUTTONS** — *Navigate Page-By-Page*

1. SEARCH FUNCTION *Navigate By Part Number Or Keyword*

Click the SEARCH button  on the PDF's top bar.

On-the-right side of the screen, enter any part number, or keyword, into the data field. Click SEARCH. Results are displayed in the window directly below the field.

Click on any result and the corresponding page will be displayed.

NOTE: You can also jump to specific pages by clicking the left-side BOOKMARKS tab.  Click any of the bookmarks listed and it's corresponding page will be displayed.

2. DOCUMENT LINKS

Navigate To Catalog Menus

Links located on each PDF page can help you quickly jump to areas of interest. At the top of page one, for example, are links that allow you to immediately access either of the catalog's two major CONTENT MENU's.

From the CONTENT MENU you can link to any connector SERIES MENU.

The connector SERIES MENU offers a variety of links to data about that particular series of connectors.

RETURN to an earlier menu at any time by clicking the link at the top of any page.



3. PAGE-ADVANCE BUTTONS

Navigate Page-By-Page

Click on either arrow at the bottom of the PDF window. This will allow you to view the catalog page-by-page.

To jump to the first or last page of the catalog, click on the respective outside arrow.



[BACK TO MAIN MENU](#)

CONNECTORS

CONTENTS

CLICK ON YOUR SELECTION:

ADDITIONAL CONNECTORS/POLE SIZES AVAILABLE IN THE YESC KAIZEN SECTION OF THIS CATALOG

OVERVIEW	
SYSTEM FEATURES	
0.64 x 0.8 UNSEALED	0.64 SERIES
0.64 x 0.8 SEALED	
1.5 x 0.8 UNSEALED	1.5 SERIES
1.5 x 0.8 SEALED	
2.8 x 0.8 UNSEALED	2.8 SERIES
2.8 x 0.8 SEALED	
6.3 x 0.8 UNSEALED	6.3 SERIES
6.3 x 0.8 SEALED	
HYBRID	HYBRID SERIES
HEADER	HEADER SERIES
SPECIALTY UNSEALED	SPECIALTY SERIES
SPECIALTY SEALED	
TERMINAL REMOVAL	TERMINAL REMOVAL
PART NUMBERING METHODOLOGY	
YAZAKI LOCATIONS	

[DISCLAIMER](#)

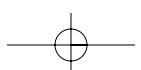

THE **YAZAKI** CONNECTION

BACK TO YESC
CONTENTS MENU

Yazaki's YESC Series has evolved from decades of intensive design refinement. As the world's largest supplier of vehicle power and data networks and associated components, Yazaki is uniquely qualified to deliver leading-edge connector solutions. The company continues to provide these innovative systems to automotive customers around the world, for vehicles of virtually every description.

The YESC Series represents an important connector resource, delivering enhanced network performance in a broad range of applications. Standards, hybrids, custom designs; sealed or unsealed – Yazaki has the connector system to meet your requirements.

YAZAKI ENGINEERING STANDARD

GO TO PAGE 2 OF 2



YAZAKI

ALL SYSTEMS GO!

Yazaki is a premier provider of innovative, robust power and data networks that are flexible, easily configurable and cost competitive. Our global reach, along with our collaborative approach and in-depth vehicle-launch support, give Yazaki customers an unprecedented resource for their power and data system needs.



Yazaki products, manufactured in plants on six continents, help power one out of every three passenger vehicles on the road, worldwide. That translates into more than 18 million connectors and 110 million terminals every day. Our leadership position reflects a commitment to excellence that has made Yazaki the industry's most innovative provider of power and data system components.



From our three design centers in North America, Japan and Europe, Yazaki advances the evolution of these critical automotive components, providing connectivity solutions that contribute to greater customer satisfaction. Our design centers apply specialized engineering expertise to the specific needs of vehicle manufacturers and their tier-supply partners. The result: Yazaki's global customers are assured of vehicle power and data solutions that deliver highly effective solutions to real-world challenges.



Our benchmark product quality – in connector systems, wire harnesses, electronics, and IP displays – delivers exceptional value and marketplace strength to our customers.





BACK TO YESC
CONTENTS MENU

YAZAKI ENGINEERING STANDARD CONNECTORS

SYSTEM FEATURES

- Wide Range of Advanced Connectors Available Immediately**
The YESC Series includes a full range of connector systems in stock – and available for immediate delivery worldwide – for virtually any vehicle application.
- USCAR / ISO Standard Compliant**
Terminal blade sizes are in accordance with USCAR and ISO standards (0.64 x 0.64, 1.5 x 0.8, 2.8 x 0.8, 6.3 x 0.8).
- Terminal Position Assurance Device**
Yazaki's Terminal Position Assurance Device is available front-loaded and preset to the connector housing.
- Connector Position Assurance Device**
The Connector Position Assurance Device is available preset to the female terminal connector housing.
- Wire Gauges for Every Application**
The YESC Series is compatible with a wide range of both US (AWG) and metric (mm²) wire sizes.

SEALED

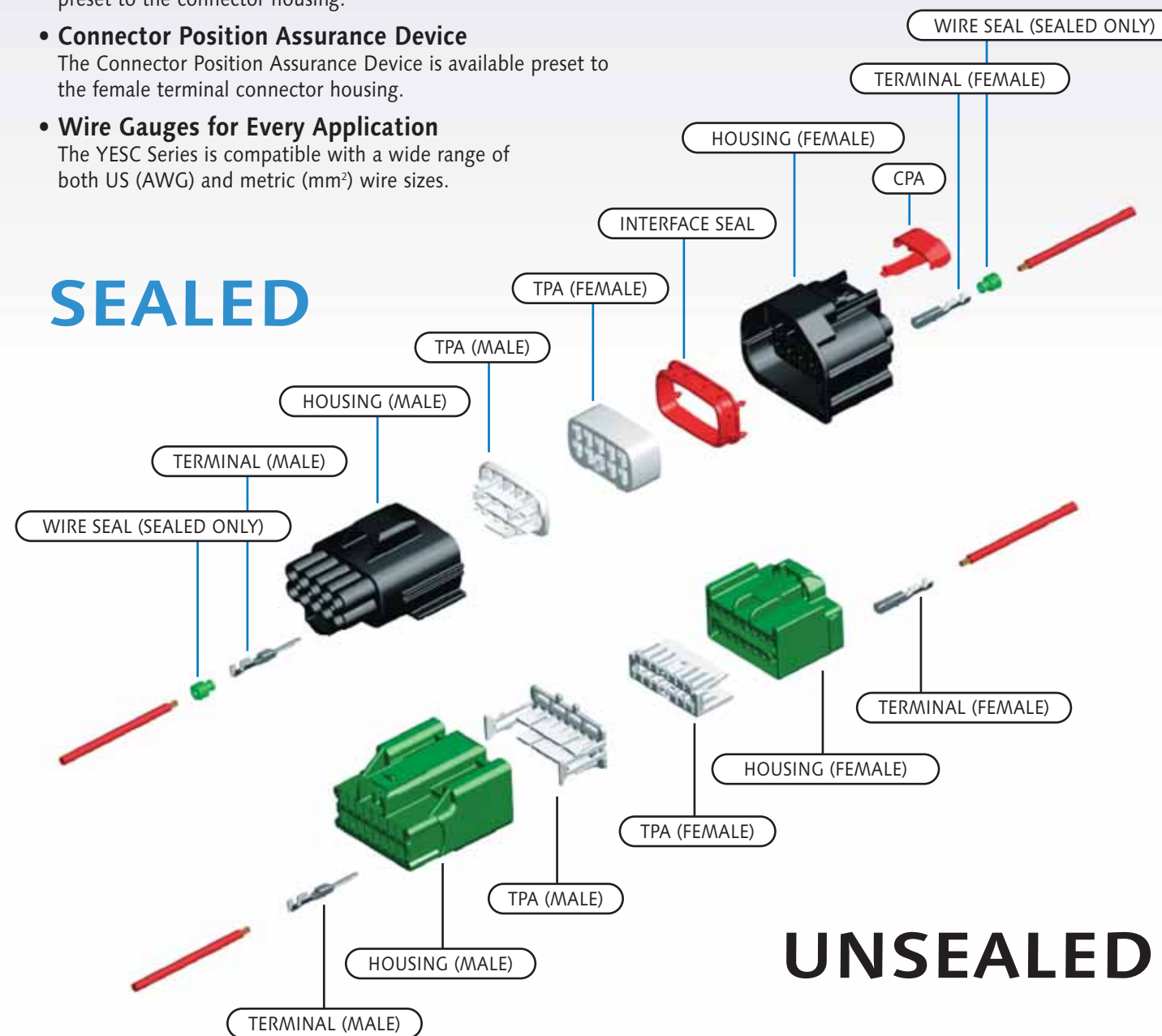

UNSEALED

[BACK TO YESC CONTENTS MENU](#)



CONNECTORS

0.64

SERIES

UNSEALED

0.64 SERIES
UNSEALED

CLICK ON YOUR SELECTION:

- CONSTRUCTION
- SPECIFICATIONS
- CURRENT RATING CURVE
- TERMINAL
- RETAINER CLIP/BRACKET DIMENSIONS
- PART NUMBER SUMMARY CHART
- PHOTOS/DIMENSIONS
- NAVIGATION TIPS



YAZAKI ENGINEERING STANDARD CONNECTORS

0.64 x 0.8

unsealed connection system

Construction

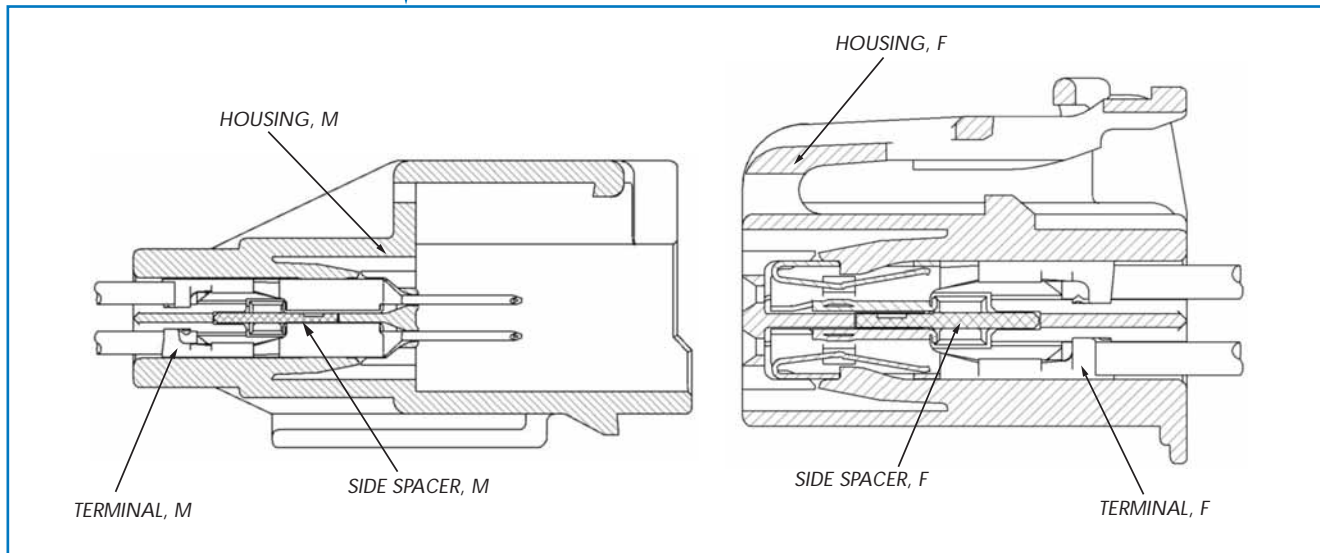

Specifications

Material	Connector	PBT + GF
	Male Terminal	Copper Alloy (Sn/Au Plate)
	Female Terminal	Copper Alloy (Sn/Au Plate)
Operating Temperature Range		-40°C ~ 100°C (120°C max temp.) (USCAR Class II)
Current Capacity		(See Chart)
Voltage Drop		20mΩ Max (Term./Term.) (Crimp-To-Crimp)
Isolation Resistance		500VDC, 20MΩ Min
Dielectric Resistance		1000VAC (1 min.)
Applicable Wire Size		22AWG ~ 18AWG (0.22mm ² ~ 0.76mm ²)
Terminal Pitch		Horizontal: 2.54mm; Vertical: 2.54mm
Terminal-to-Connector Retention Force		75N Min
Connector-to-Connector Retention Force		110N Min

Current Rating Curve (Reference Only)

This data is based on single circuit/connector evaluation. Data should be used as reference only. Appropriate derating should be considered based upon specific application requirements.

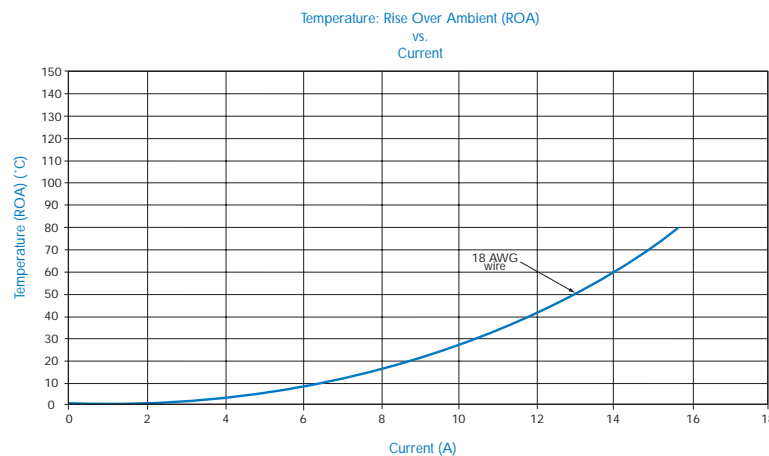

unsealed connection system

0.64 x 0.8

Terminal

UNIT: mm

Male Terminal

Material: Copper Alloy Thickness: $t=0.3$

Female Terminal

Material: Copper Alloy Thickness: $t=0.25$

Description	Part Number	Plating	Applicable Wire Size		
			Europe (mm ²)	U.S.A. (AWG)	Japan (mm ²)
Male Terminal	7114-4720-02	Sn	0.35	22	0.3
	7114-4721-02	Sn	0.35	22	0.3
	7114-3286-08	Au	0.35	22	0.3
	7114-3287-08	Au	0.5 ~ 0.75	20 ~ 18	0.5 ~ 0.85
Female Terminal	7116-4720-02	Sn	0.35	22	0.3
	7116-4721-02	Sn	0.5 ~ 0.75	20 ~ 18	0.5 ~ 0.85
	7116-4720-08	Au	0.35	22	0.3
	7116-4721-08	Au	0.5 ~ 0.75	20 ~ 18	0.5 ~ 0.85

Retainer Clip/Bracket Dimensions

UNIT: mm

Part Number	Panel Hole Requirements
7047-9580 (Ref)	φ6.5mm

0.64 x 0.8

unsealed connection system

Part Number Summary Chart

Part Name	Male	Female
Terminal	7114-4720-02	7116-4720-02
	7114-4721-02	7116-4721-02
	7114-3286-08	7116-4720-08
	7114-3287-08	7116-4721-08
Applicable Clip	7047-9580 (Ref)	N/A

Pole	Polarity	Color	Male Part #	Female Part #	Female Part # (w/CPA)
4	A	Light Grey	7282-6560-40	7283-6386-40	7283-6560-40
6	A	Light Grey	7282-6561-40	7283-6387-40	7283-6561-40
8	A	Light Grey	7282-8870-40	7283-8873-40	7283-8872-40
12	A	Light Grey	7282-7696-40	7283-7696-40	7283-7697-40
20	A	Light Grey	7282-6568-40	7283-6388-40	7283-6568-40

*Applicable Terminal Removal Tool/Dimensions

Refer to Page 68 for YES Connector Terminal Removal Tool.
Order Number: 49YA000105.

unsealed connection system

0.64 x 0.8

Housing Material: PBT+GF

UNIT: mm

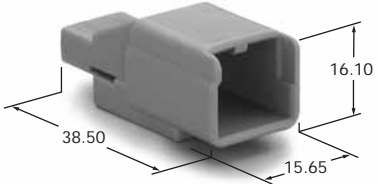
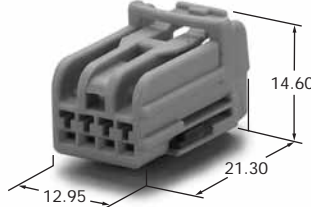
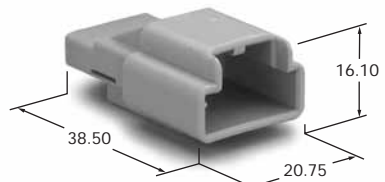
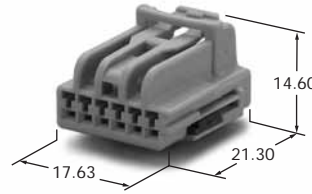
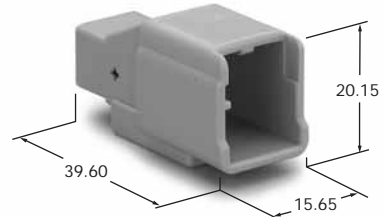
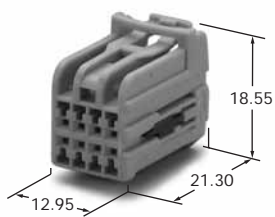
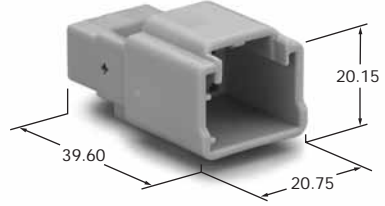
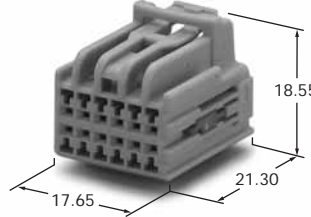
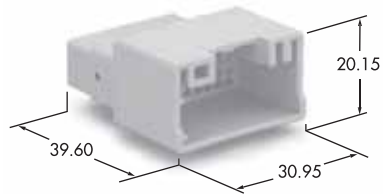
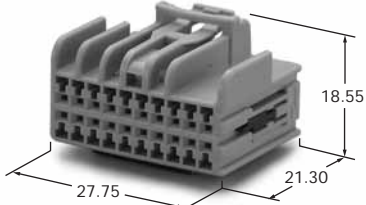
Poles	Male Housing	Female Housing
4	 <p>7282-6560-40</p>	 <p>7283-6386-40</p>
6	 <p>7282-6561-40</p>	 <p>7283-6387-40</p>
8	 <p>7282-8870-40</p>	 <p>7283-8873-40</p>
12	 <p>7282-7696-40</p>	 <p>7283-7696-40</p>
20	 <p>7282-6568-40</p>	 <p>7283-6388-40</p>

YESC

CONNECTORS

0.64

SERIES

SEALED

0.64 SERIES
SEALED

CLICK ON YOUR SELECTION:

- CONSTRUCTION
- SPECIFICATIONS
- CURRENT RATING CURVE
- TERMINAL
- RETAINER CLIP/BRACKET DIMENSIONS
- PART NUMBER SUMMARY CHART
- PHOTOS/DIMENSIONS
- NAVIGATION TIPS

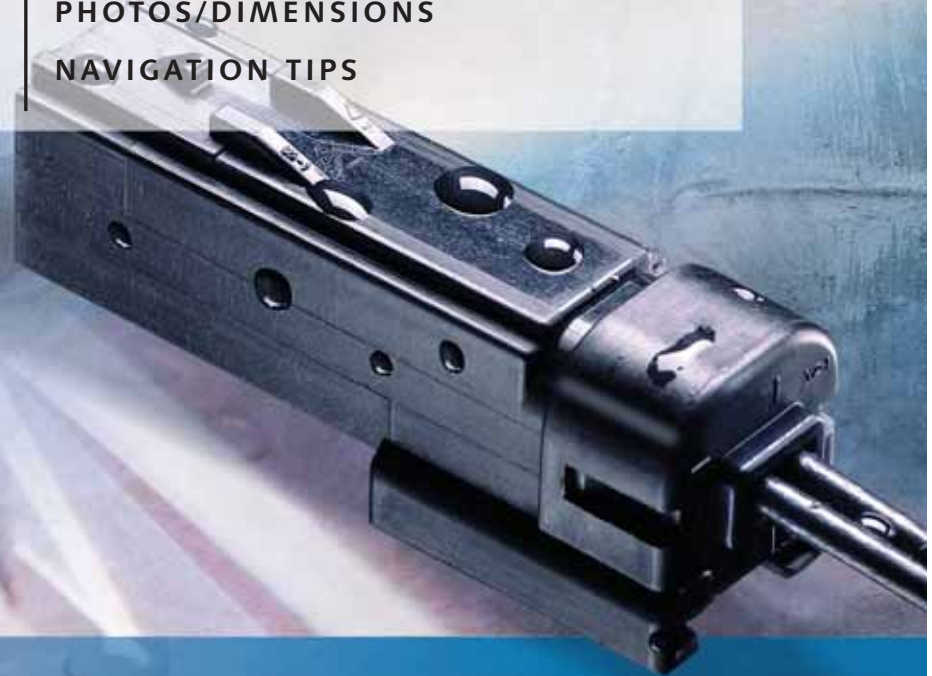

YAZAKI ENGINEERING STANDARD CONNECTORS

0.64 x 0.8

sealed connection system

Construction

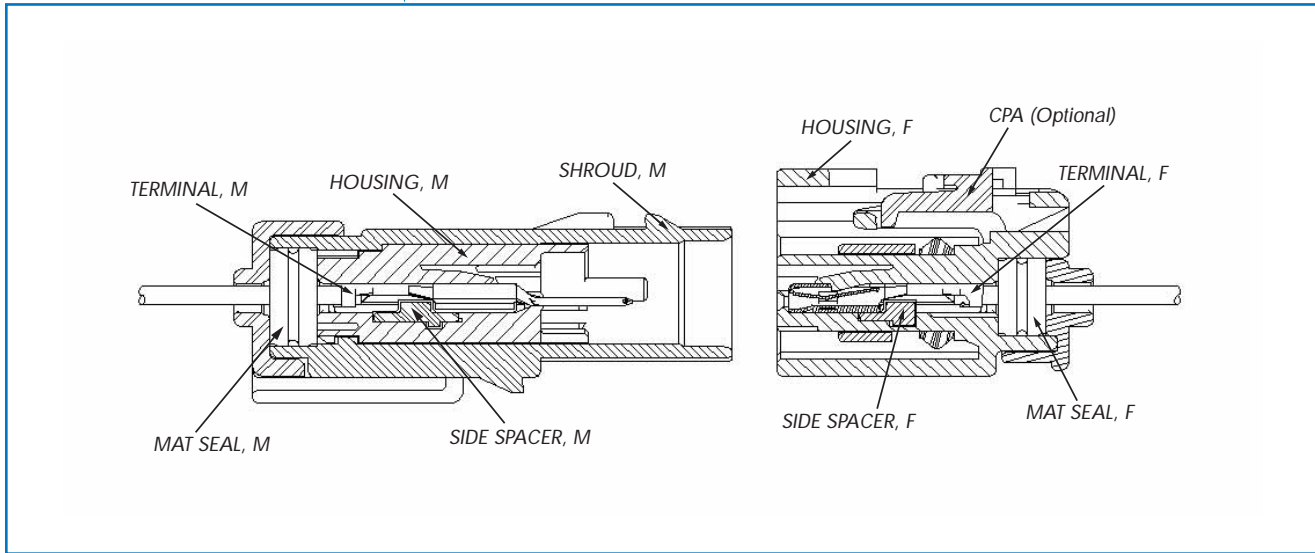

Specifications

Material	Connector	PBT + GF
	Male Terminal	Copper Alloy (Sn/Au Plate)
	Female Terminal	Copper Alloy (Sn/Au Plate)
Operating Temperature Range		-40°C ~125°C (145°C max temp.) (USCAR Class III)
Current Capacity		(See Chart)
Voltage Drop		20mΩ Max (Term./Term.) (Crimp-To-Crimp)
Isolation Resistance		500VDC, 20MΩ Min
Dielectric Resistance		1000VAC (1 min.)
Applicable Wire Size		22AWG ~ 18AWG (0.22mm ² ~ 0.76mm ²)
Terminal Pitch		Horizontal: 2.54mm; Vertical: 2.54mm
Sealing Performance (Air Leak Pressure)		48kPa Min (Pre-Heat Soak); 28kPa (Post-Heat Soak)
Terminal-to-Connector Retention Force		75N Min
Connector-to-Connector Retention Force		110N Min

Current Rating Curve (Reference Only)

This data is based on single circuit/connector evaluation. Data should be used as reference only. Appropriate derating should be considered based upon specific application requirements.

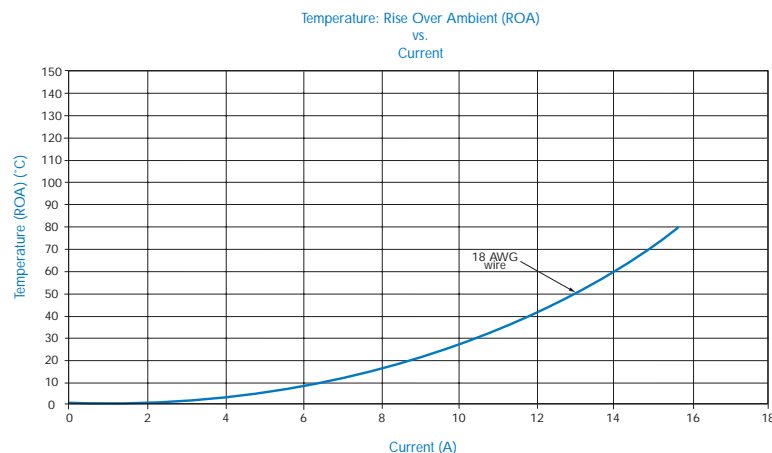

sealed connection system

0.64 x 0.8

Terminal

UNIT: mm

Male Terminal

Material: Copper Alloy Thickness: t=0.3

Female Terminal

Material: Copper Alloy Thickness: t=0.25

Description	Part Number	Plating	Applicable Wire Size		
			Europe (mm ²)	U.S.A. (AWG)	Japan (mm ²)
Male Terminal	7114-4720-02	Sn	0.35	22	0.3
	7114-4721-02	Sn	0.5 ~ 0.75	20 ~ 18	0.5 ~ 0.85
	7114-3286-08	Au	0.35	22	0.3
	7114-3287-08	Au	0.5 ~ 0.75	20 ~ 18	0.5 ~ 0.85
Female Terminal	7116-4720-02	Sn	0.35	22	0.3
	7116-4721-02	Sn	0.5 ~ 0.75	20 ~ 18	0.5 ~ 0.85
	7116-4720-08	Au	0.35	22	0.3
	7116-4721-08	Au	0.5 ~ 0.75	20 ~ 18	0.5 ~ 0.85

Retainer Clip/Bracket Dimensions

UNIT: mm

Part Number	Panel Hole Requirements
7047-9580 (Ref)	φ6.5mm

0.64 x 0.8

sealed connection system

Part Number Summary Chart

Part Name	Male	Female
<i>Terminal</i>	7114-4720-02	7116-4720-02
	7114-4721-02	7116-4721-02
	7114-3286-08	7116-4720-08
	7114-3287-08	7116-4721-08
<i>Applicable Clip</i>	7047-9580 (Ref)	N/A

Pole	Polarity	Color	Male Part #	Female Part #	Female Part # (w/CPA)
2	A	Black	7282-6075-30	7283-6078-30	7283-6076-30

Housing Material: PBT+GF

UNIT: mm

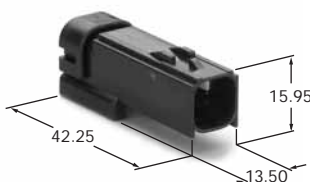
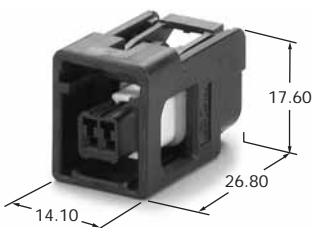
Poles	Male Housing	Female Housing
2	 <p>7282-6075-30</p>	 <p>7283-6078-30</p>

***Applicable Terminal Removal Tool/Dimensions**
 Refer to Page 68 for YES Connector Terminal Removal Tool.
 Order Number: 49YA000105.



CONNECTORS

1.5 SERIES UNSEALED

1.5 SERIES
UNSEALED

CLICK ON YOUR SELECTION:

- CONSTRUCTION
- SPECIFICATIONS
- CURRENT RATING CURVE
- TERMINAL
- RETAINER CLIP/BRACKET DIMENSIONS
- PART NUMBER SUMMARY CHART
- PHOTOS/DIMENSIONS
- NAVIGATION TIPS



1.5 x 0.8

unsealed connection system

Construction

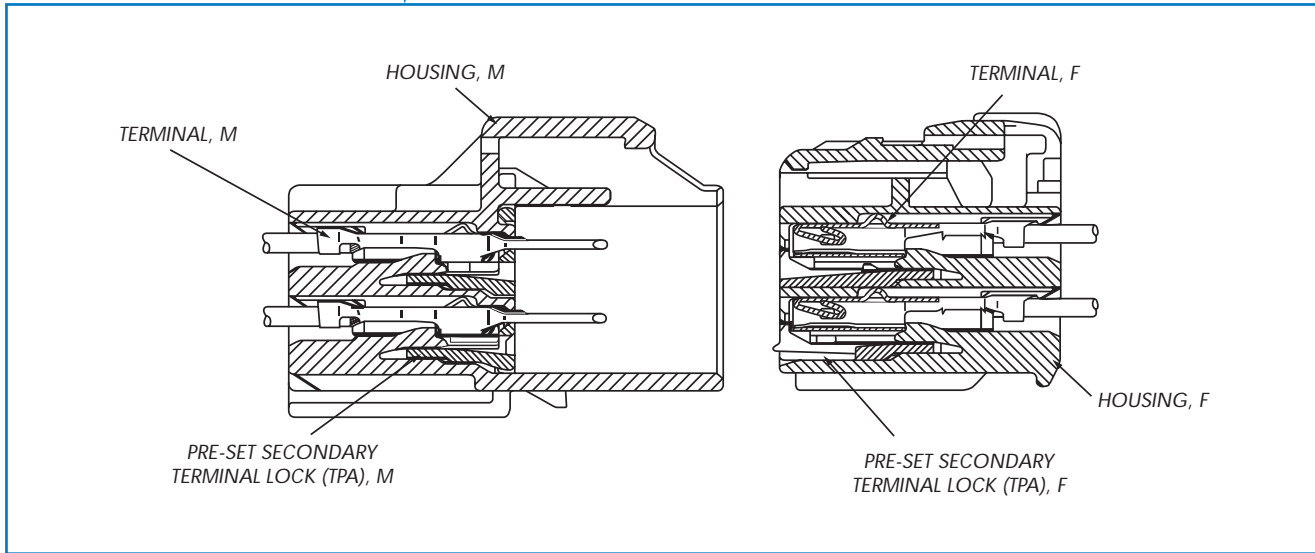

Specifications

Material	Connector	HPA
	Male Terminal	Copper Alloy (Sn/Au Plate)
	Female Terminal	Copper Alloy (Sn/Au Plate)
Operating Temperature Range		-40°C ~125°C (145°C max temp.) (USCAR Class III)
Current Capacity		(See Chart)
Voltage Drop		10mΩ Max (Term./Term.) (Crimp-To-Crimp)
Isolation Resistance		500VDC, 20MΩ Min
Dielectric Resistance		1000VAC (1 min.)
Applicable Wire Size		22AWG ~ 16AWG (0.35mm ² ~ 1.0mm ²)
Terminal Pitch		Horizontal: 3.50mm; Vertical: 6.50mm
Terminal-to-Connector Retention Force		90N Min
Connector-to-Connector Retention Force		110N Min

Current Rating Curve (Reference Only)

This data is based on single circuit/connector evaluation. Data should be used as reference only. Appropriate derating should be considered based upon specific application requirements.

0.35mm² rating curve not shown. Current capability of terminal exceeds capacity of wire.

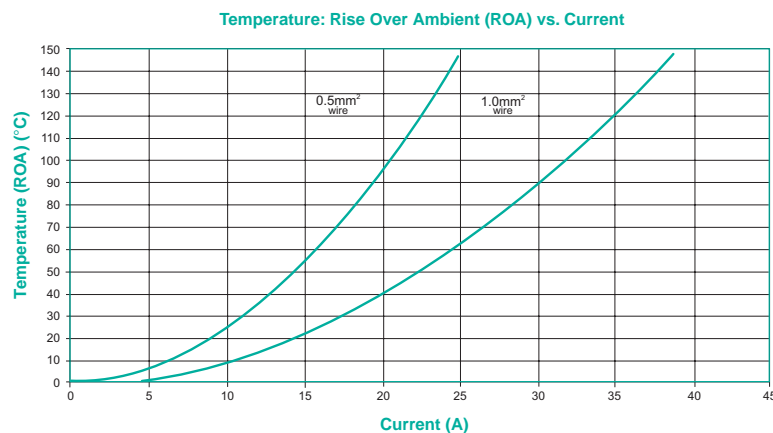

unsealed connection system

1.5 x 0.8

Terminal

UNIT: mm

Male Terminal

Material: Copper Alloy Thickness: $t=0.3$

Female Terminal

Material: Copper Alloy Thickness: $t=0.25$

Description	Part Number	Plating	Applicable Wire Size		
			Europe (mm ²)	U.S.A. (AWG)	Japan (mm ²)
Male Terminal	7114-4100-02	Sn	0.35 ~ 0.5	22 ~ 20	0.3 ~ 0.5
	7114-4101-02	Sn	0.75 ~ 1.0	18 ~ 16	0.85 ~ 1.25
	7114-4100-08	Au	0.35 ~ 0.5	22 ~ 20	0.3 ~ 0.5
	7114-4101-08	Au	0.75 ~ 1.0	18 ~ 16	0.85 ~ 1.25
Female Terminal	7116-4100-02	Sn	0.35 ~ 0.5	22 ~ 20	0.3 ~ 0.5
	7116-4101-02	Sn	0.75 ~ 1.0	18 ~ 16	0.85 ~ 1.25
	7116-4100-08	Au	0.35 ~ 0.5	22 ~ 20	0.3 ~ 0.5
	7116-4101-08	Au	0.75 ~ 1.0	18 ~ 16	0.85 ~ 1.25

Retainer Clip/Bracket Dimensions

UNIT: mm

Part Number	Panel Hole Requirements
7047-9580 (Ref)	φ6.5mm

1.5 x 0.8

unsealed connection system

Part Number Summary Chart

Part Name	Male	Female
Terminal	7114-4100-02	7116-4100-02
	7114-4101-02	7116-4101-02
	7114-4100-08	7116-4100-08
	7114-4101-08	7116-4101-08
Applicable Clip	7047-9580 (Ref)	N/A

Pole	Polarity	Color	Male Part #	Female Part #	Female Part # (w/CPA)	Delete Cap
2	A	Light Grey			7283-5904-40	7282-5555-40
3	A	Light Grey			7283-5905-40	
4	A	Light Grey			7283-5906-40	
4	B	Green			7283-6475-60	
6	A	Light Grey			7283-5907-40	7282-5944-40
8	A	Light Grey			7283-5908-40	
10	A	Light Grey			7283-5909-40	
10	B	Green	7282-5683-60			
12	A	Light Grey			7283-5940-40	
16	A	Green			7283-5941-60	7282-5690-60
16	C	Light Grey	7282-5536-40			

Housing Material: HPA

UNIT: mm

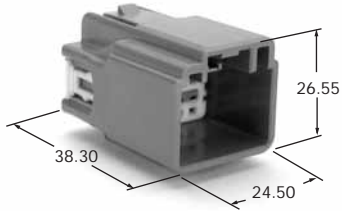
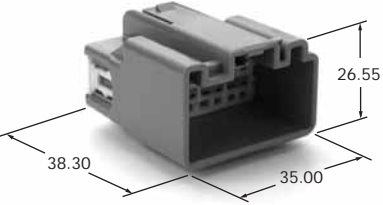
Poles	Male Housing	Female Housing
10	 <p>7282-5683-60 Please check YESC KAIZEN Catalog for new part.</p>	N/A
16	 <p>7282-5536-40 Please check YESC KAIZEN Catalog for new part.</p>	N/A

*Applicable Terminal Removal Tool/Dimensions

Refer to Page 68 for YES Connector Terminal Removal Tool. Order Number: X39899-J374.

Please check the YESC KAIZEN catalog for additional parts.



[BACK TO YESC CONTENTS MENU](#)

CONNECTORS

1.5 SERIES SEALED

1.5 SERIES
SEALED

CLICK ON YOUR SELECTION:

- CONSTRUCTION
- SPECIFICATIONS
- CURRENT RATING CURVE
- TERMINAL
- CABLE SEAL
- RETAINER CLIP/BRACKET DIMENSIONS
- PART NUMBER SUMMARY CHART
- PHOTOS/DIMENSIONS
- NAVIGATION TIPS



YAZAKI ENGINEERING STANDARD CONNECTORS

1.5 x 0.8

sealed connection system

Construction

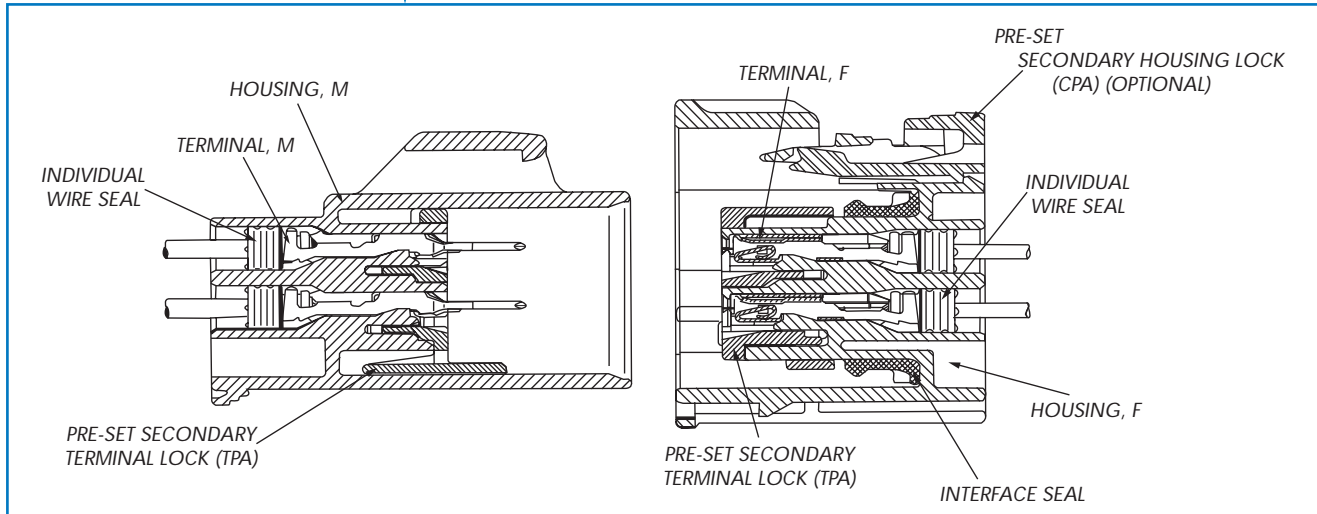

Specifications

Material	Connector	HPA
	Male Terminal	Copper Alloy (Sn/Au Plate)
	Female Terminal	Copper Alloy (Sn/Au Plate)
Operating Temperature Range		-40°C ~ 125°C (145°C max temp.) (USCAR Class III)
Current Capacity		(See Chart)
Voltage Drop		10mΩ Max (Term./Term.) (Crimp-To-Crimp)
Isolation Resistance		500VDC, 20MΩ Min
Dielectric Resistance		1000VAC (1 min.)
Applicable Wire Size		22AWG ~ 16AWG (0.35mm ² ~ 1.0mm ²)
Terminal Pitch		Horizontal: 5.50mm; Vertical: 6.50mm
Sealing Performance (Air Leak Pressure)		48kPa Min (Pre-Heat Soak); 28kPa (Post-Heat Soak)
Terminal-to-Connector Retention Force		90N Min
Connector-to-Connector Retention Force		110N Min

Current Rating Curve (Reference Only)

This data is based on single circuit/connector evaluation. Data should be used as reference only. Appropriate derating should be considered based upon specific application requirements.

0.35mm² rating curve not shown. Current capability of terminal exceeds capacity of wire.

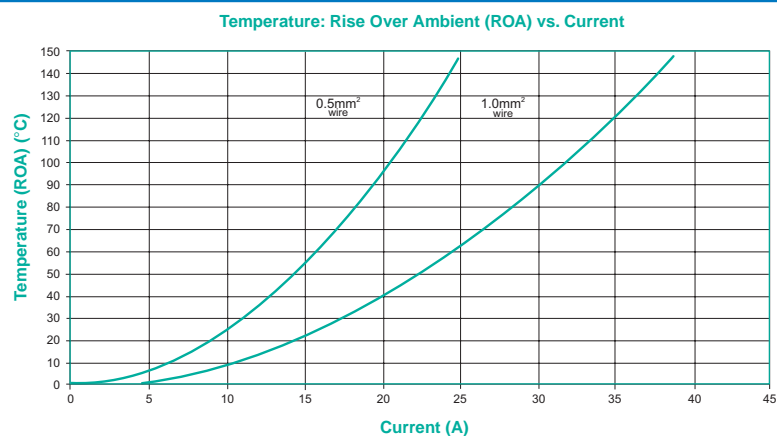

sealed connection system

1.5 x 0.8

Terminal

UNIT: mm

Male Terminal

Material: Copper Alloy Thickness: $t=0.3$

Female Terminal

Material: Copper Alloy Thickness: $t=0.25$

Description	Part Number	Plating	Applicable Wire Size		
			Europe (mm ²)	U.S.A. (AWG)	Japan (mm ²)
Male Terminal	7114-4102-02	Sn	0.35 ~ 0.5	22 ~ 20	0.3 ~ 0.5
	7114-4103-02	Sn	0.75 ~ 1.0	18 ~ 16	0.85 ~ 1.25
	7114-4102-08	Au	0.35 ~ 0.5	22 ~ 20	0.3 ~ 0.5
	7114-4103-08	Au	0.75 ~ 1.0	18 ~ 16	0.85 ~ 1.25
Female Terminal	7116-4102-02	Sn	0.35 ~ 0.5	22 ~ 20	0.3 ~ 0.5
	7116-4103-02	Sn	0.75 ~ 1.0	18 ~ 16	0.85 ~ 1.25
	7116-4102-08	Au	0.35 ~ 0.5	22 ~ 20	0.3 ~ 0.5
	7116-4103-08	Au	0.75 ~ 1.0	18 ~ 16	0.85 ~ 1.25

Cable Seal

UNIT: mm

Description	Part Number	Color	Material	Wire O.D. Range
Cable Seal	7158-3030-50	Red	Silicone	1.19 ~ 1.70
	7158-3031-90	Blue	Silicone	1.60 ~ 2.34
Unused Cavity Plug	7158-3032-60	Green	Silicone	N/A

Retainer Clip/Bracket Dimensions

UNIT: mm

Part Number	Panel Hole Requirements
7047-9580 (Ref.)	$\phi 6.5\text{mm}$

1.5 x 0.8

sealed connection system

Part Number Summary Chart

Part Name	Male	Female
<i>Terminal</i>	7114-4102-02	7116-4102-02
	7114-4103-02	7116-4103-02
	7114-4102-08	7116-4102-08
	7114-4103-08	7116-4103-08
<i>Cable Seal</i>	7158-3030-50	
	7158-3031-90	
<i>Unused Cavity Plug</i>	7158-3032-60	
<i>Applicable Clip</i>	N/A	7047-9580 (Ref)

Pole	Polarity	Color Description	Male Part #	Female Part #	Female Part # (w/CPA)	Delete Cap
2	A	Black	7282-5548-30	7283-5548-30	7283-5549-30	
2	B	Dark Grey	7282-5558-10			
2		Black/Direct only		7283-5689-30		
2		Dark Grey/Direct only			7283-6432-10	
2		Natural/Direct only			7283-6433	
2		Light Grey/Direct only			7283-6434-40	
3	A	Black	7282-5541-30			
3	B	Dark Grey	7282-5691-10	7283-5691-10	7283-5880-10	
3		Black/Direct only		7283-5537-30		
4	2-Row A	Dark Grey	7282-5543-10	7283-5543-10	7283-5544-10	
4	2-Row B	Black	7282-5889-30	7283-5889-30		
4	2-Row B	Blue	7282-5889-90	7283-5889-90		
5	A	Black		7283-5547-30	7283-5550-30	
6	A	Dark Grey	7282-5553-10	7283-5553-10	7283-5554-10	
6	A	Black	7282-5553-30	7283-5553-30	7283-5554-30	
8	A	Dark Grey	7282-5684-10			
8	A	Black	7282-5684-30			
10	2-Row A	Black	7282-5946-30	7283-5946-30	7283-5947-30	
10	2-Row B	Dark Grey, #1 Pin Neg.			7283-5694-10	
10	2-Row B	Light Grey, #1 Pin Neg.		7283-5948-40	7283-5694-40	
10	2-Row B	Black, #5 & #9 Pin Neg.			7283-5695-30	
10	2-Row B	Black, #1 & #5 Pin Neg.		7283-6472-30	7283-6473-30	
10	5-Row A	Black/ PBT Material		7283-6478-30	7283-6479-30	
12	A	Dark Grey	7283-5545-10	7283-5546-10	7282-5545-10	
12	A	Black	7282-5545-30	7283-5545-30	7283-5546-30	
18	A	Black	7282-6493-30	7283-6493-30		

*** Applicable Terminal Removal Tool/Dimensions**





Refer to Page 68 for YES Connector Terminal Removal Tool.
Order Number: X39899-J374.

sealed connection system

1.5 x 0.8

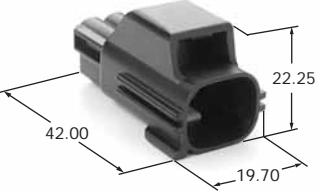
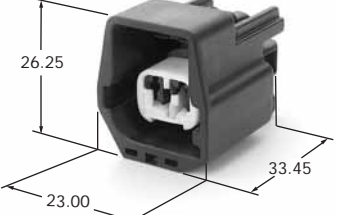
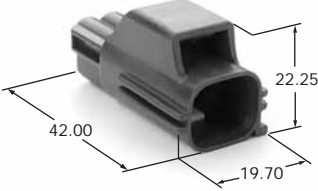
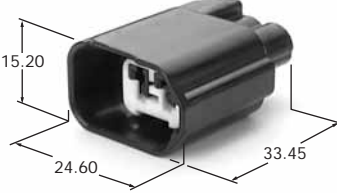
Housing Material: HPA

UNIT: mm





Poles	Male Housing	Female Housing
2	 <p>7282-5548-30</p>	 <p>7283-5548-30</p>
2	 <p>7282-5558-10</p>	<p>N/A Please check YESC KAIZEN Catalog for the mate.</p>
2	<p>N/A</p>	 <p>7283-5689-30</p>
2	<p>N/A</p>	 <p>7283-6432-10</p>
2	<p>N/A</p>	 <p>7283-6433</p>
2	<p>N/A</p>	 <p>7283-6434-40</p>

1.5 x 0.8

sealed connection system

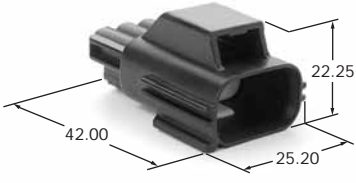
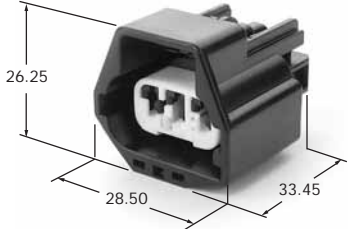
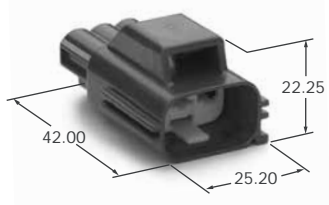
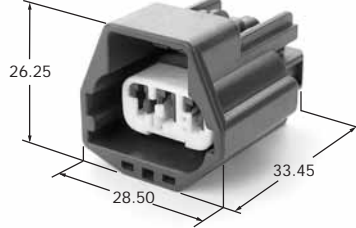
Housing Material: HPA

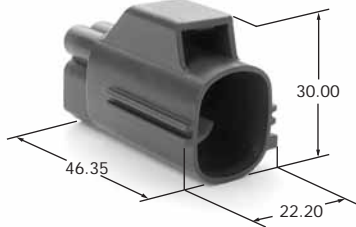
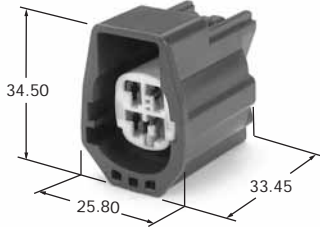
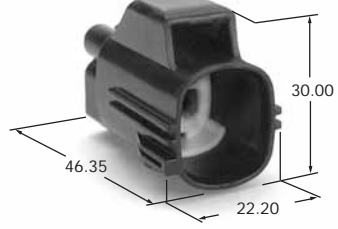
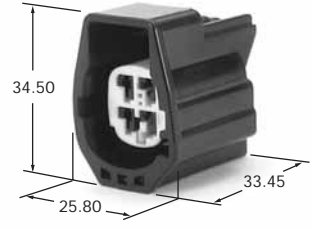
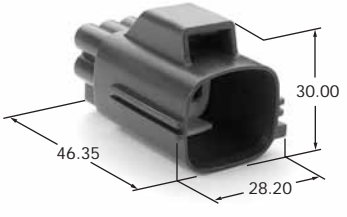
UNIT: mm





Poles	Male Housing	Female Housing
3	 <p>7282-5541-30</p>	 <p>7283-5541-30</p>
3	 <p>7282-5691-10</p>	 <p>7283-5691-10</p>
3	N/A	 <p>7283-5537-30</p>
4	 <p>7282-5543-10</p>	 <p>7283-5543-10</p>
4	 <p>7282-5889-30</p>	 <p>7283-5889-30</p>
6	 <p>7282-5553-10</p>	 <p>7283-5553-10</p>

sealed connection system

1.5 x 0.8

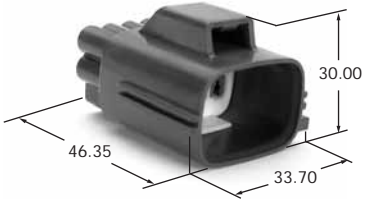
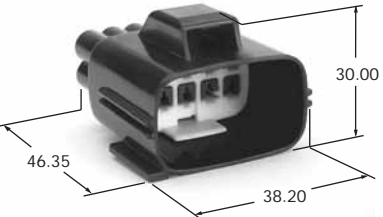
Housing Material: HPA

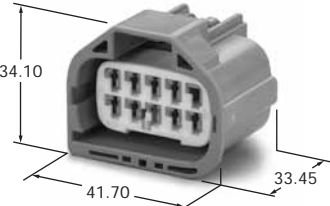
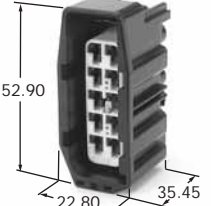
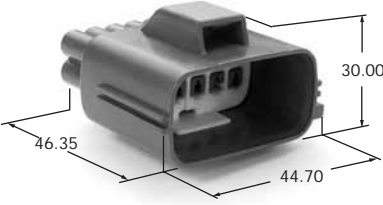
UNIT: mm

8	 <p>7282-5684-10</p>	<p>N/A Please check YESC KAIZEN Catalog for the mate.</p>
10	 <p>7282-5946-30</p>	 <p>7283-5946-30</p>
10	<p>N/A</p>	 <p>7283-5948-40</p>
10	<p>N/A</p>	 <p>7283-6478-30</p>
12	 <p>7282-5545-10</p>	 <p>7283-5545-10</p>

YESC

CONNECTORS

2.8

SERIES

UNSEALED

CLICK ON YOUR SELECTION:

- CONSTRUCTION
- SPECIFICATIONS
- CURRENT RATING CURVE
- TERMINAL
- RETAINER CLIP/BRACKET DIMENSIONS
- PART NUMBER SUMMARY CHART
- PHOTOS/DIMENSIONS
- NAVIGATION TIPS

2.8 SERIES
UNSEALED



YAZAKI ENGINEERING STANDARD CONNECTORS

2.8 x 0.8

unsealed connection system

Construction

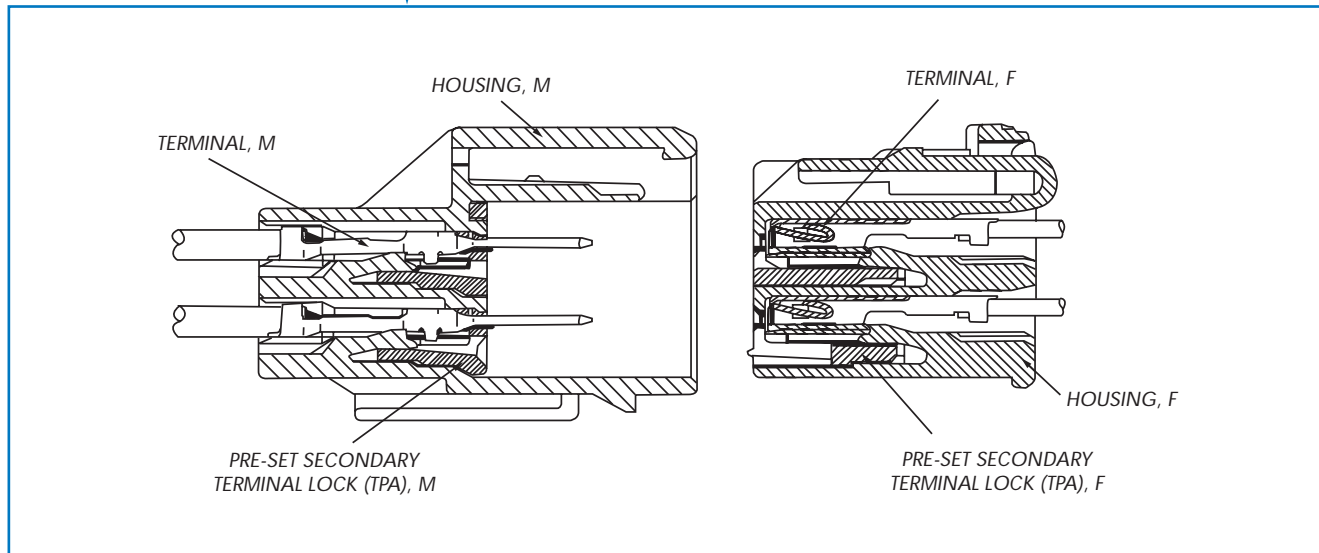

Specifications

Material	Connector	HPA
	Male Terminal	Copper Alloy (Sn Plate)
	Female Terminal	Copper Alloy (Sn Plate)
Operating Temperature Range		-40°C ~ 125°C (145°C max temp.) (USCAR Class III)
Current Capacity		(See Chart)
Voltage Drop		10mΩ Max (Term./Term.) (Crimp-To-Crimp)
Isolation Resistance		500VDC, 20MΩ Min
Dielectric Resistance		1000VAC (1 min.)
Applicable Wire Size		22AWG ~ 14AWG (0.35mm ² ~ 2.5mm ²)
Terminal Pitch		Horizontal: 5.00mm; Vertical: 6.80mm
Terminal-to-Connector Retention Force		90N Min
Connector-to-Connector Retention Force		110N Min

Current Rating Curve (Reference Only)

This data is based on single circuit/connector evaluation. Data should be used as reference only. Appropriate derating should be considered based upon specific application requirements.

0.35mm² rating curve not shown. Current capability of terminal exceeds capacity of wire.

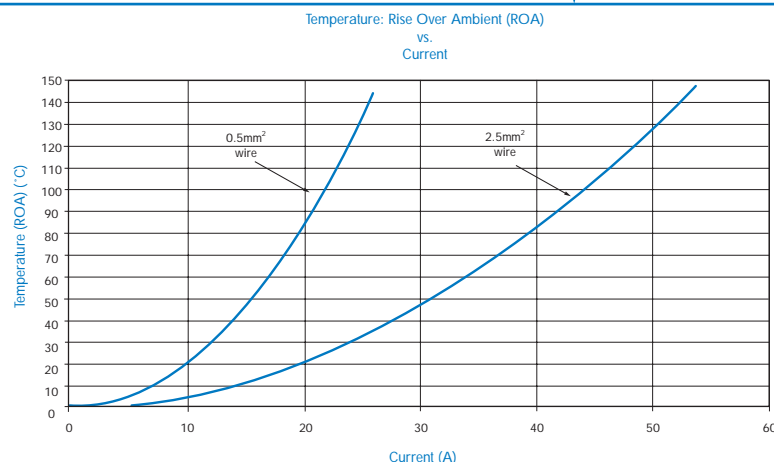

unsealed connection system

2.8 x 0.8

Terminal

UNIT: mm

Male Terminal

Material: Copper Alloy Thickness: $t=0.3$

Female Terminal

Material: Copper Alloy Thickness: $t=0.3$

Description	Part Number	Plating	Applicable Wire Size		
			Europe (mm ²)	U.S.A. (AWG)	Japan (mm ²)
Male Terminal	7114-4110-02	Sn	0.35 ~ 0.5	22 ~ 20	0.3 ~ 0.5
	7114-4111-02	Sn	0.75 ~ 1.0	18 ~ 16	0.85 ~ 1.25
	7114-4112-02	Sn	1.5 ~ 2.5	14	2.0
Female Terminal	7116-4110-02	Sn	0.35 ~ 0.5	22 ~ 20	0.3 ~ 0.5
	7116-4111-02	Sn	0.75 ~ 1.0	18 ~ 16	0.85 ~ 1.25
	7116-4112-02	Sn	1.5 ~ 2.5	14	2.0

Retainer Clip/Bracket Dimensions

UNIT: mm

Part Number	Panel Hole Requirements
7047-9580 (Ref)	φ6.5mm

2.8 x 0.8

unsealed connection system

Part Number Summary Chart

Part Name	Male	Female
<i>Terminal</i>	7114-4110-02	7116-4110-02
	7114-4111-02	7116-4111-02
	7114-4112-02	7116-4112-02
<i>Applicable Clip</i>	7047-9580 (Ref)	N/A

Pole	Polarity	Color	Male Part #	Female Part #	Female Part # (w/CPA)	Delete Cap
2	A	Light Grey			7283-5910-40	
3	A	Light Grey	7282-5563-40	7283-5563-40	7283-5911-40	
4	A	Light Grey			7283-5912-40	
4	B	Green	7282-5566-60	7283-5566-60		
6	A	Light Grey			7283-5913-40	
7	A	Light Grey	7282-5580-40	7283-5580-40		
8		Green/Direct only		7283-6382-60		
8		Dark Grey/Direct only		7283-6384-10	7283-6383-10	
10	A	Light Grey		7283-5564-40	7283-5915-40	
12	A	Light Grey			7283-5916-40	

*Applicable Terminal Removal Tool/Dimensions

Refer to Page 68 for YES Connector Terminal Removal Tool.
Order Number: X39899-J374.

unsealed connection system

2.8 x 0.8

Housing Material: HPA

UNIT: mm

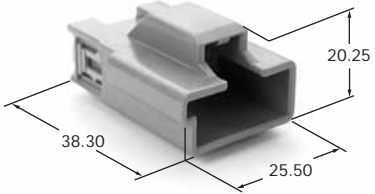
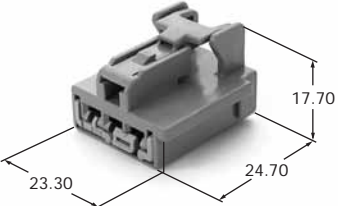
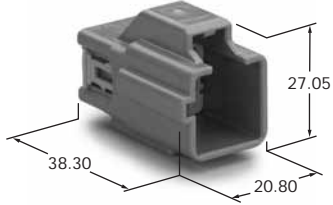
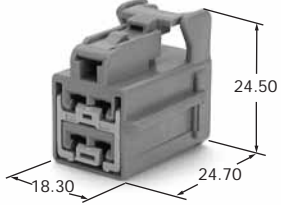
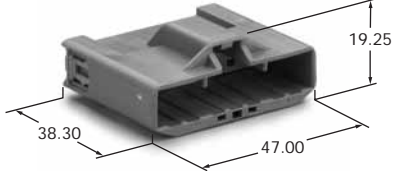
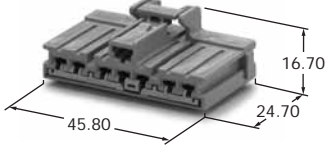
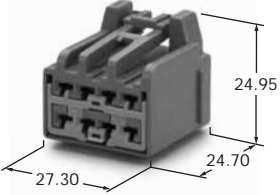
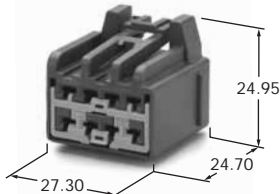
Poles	Male Housing	Female Housing
3	 <p>7282-5563-40</p>	 <p>7283-5563-40</p>
4	 <p>7282-5566-60</p>	 <p>7283-5566-60</p>
7	 <p>7282-5580-40</p>	 <p>7283-5580-40</p>
8	N/A	 <p>7283-6382-60</p>
8	N/A	 <p>7283-6384-10</p>



[BACK TO YESC CONTENTS MENU](#)

CONNECTORS

2.8 SERIES SEALED

CLICK ON YOUR SELECTION:

- CONSTRUCTION
- SPECIFICATIONS
- CURRENT RATING CURVE
- TERMINAL
- CABLE SEAL
- RETAINER CLIP/BRACKET DIMENSIONS
- PART NUMBER SUMMARY CHART
- PHOTOS/DIMENSIONS
- NAVIGATION TIPS

**2.8 SERIES
SEALED**



2.8 x 0.8

sealed connection system

Construction

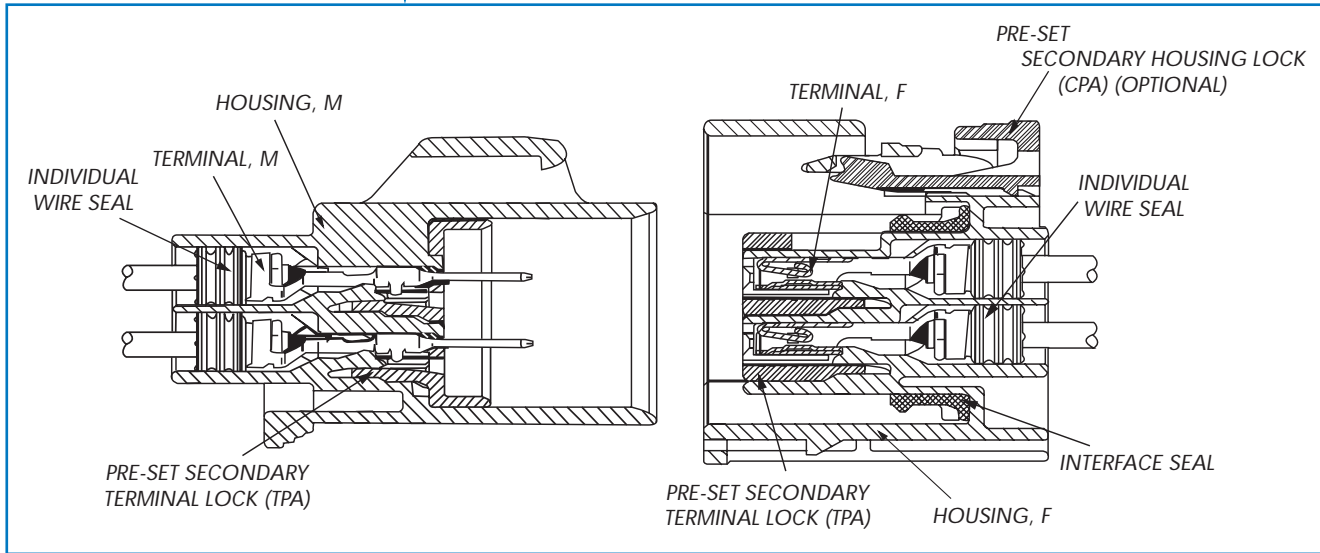

Specifications

Material	Connector	HPA
	Male Terminal	Copper Alloy (Sn Plate)
	Female Terminal	Copper Alloy (Sn Plate)
Operating Temperature Range		-40°C ~125°C (145°C max temp.) (USCAR Class III)
Current Capacity		(See Chart)
Voltage Drop		10mΩ Max (Term./Term.) (Crimp-To-Crimp)
Isolation Resistance		500VDC, 20MΩ Min
Dielectric Resistance		1000VAC (1 min.)
Applicable Wire Size		22AWG ~ 14AWG (0.35mm ² ~ 2.5mm ²)
Terminal Pitch		Horizontal: 6.80mm; Vertical: 6.80mm
Sealing Performance (Air Leak Pressure)		48kPa Min (Pre-Heat Soak); 28kPa (Post-Heat Soak)
Terminal-to-Connector Retention Force		90N Min
Connector-to-Connector Retention Force		110N Min

Current Rating Curve (Reference Only)

This data is based on single circuit/connector evaluation. Data should be used as reference only. Appropriate derating should be considered based upon specific application requirements.

0.35mm² rating curve not shown. Current capability of terminal exceeds capacity of wire.

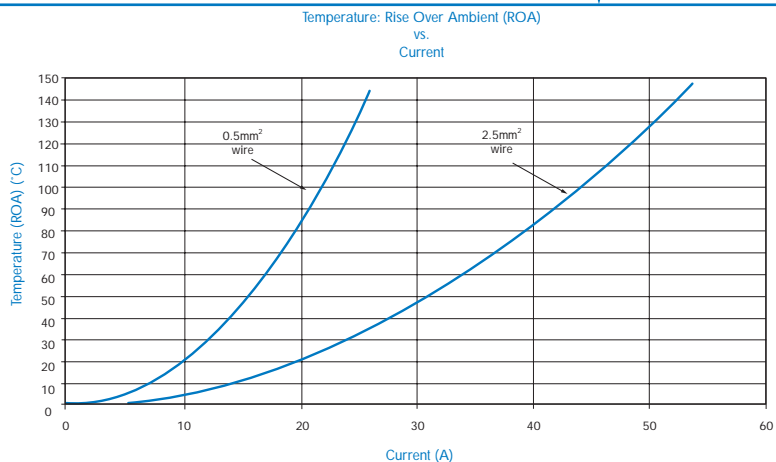

sealed connection system

2.8 x 0.8

Terminal

UNIT: mm

Male Terminal

Material: Copper Alloy Thickness: $t=0.3$

Female Terminal

Material: Copper Alloy Thickness: $t=0.3$

Description	Part Number	Plating	Applicable Wire Size		
			Europe (mm ²)	U.S.A. (AWG)	Japan (mm ²)
Male Terminal	7114-4150-02	Sn	0.35 ~ 0.5	22 ~ 20	0.3 ~ 0.5
	7114-4151-02	Sn	0.75 ~ 1.0	18 ~ 16	0.85 ~ 1.25
	7114-4152-02	Sn	1.5 ~ 2.5	14	2.0
Female Terminal	7116-4150-02	Sn	0.35 ~ 0.5	22 ~ 20	0.3 ~ 0.5
	7116-4151-02	Sn	0.75 ~ 1.0	18 ~ 16	0.85 ~ 1.25
	7116-4152-02	Sn	1.5 ~ 2.5	14	2.0

Cable Seal

UNIT: mm

ϕ 6.90 9.05

ϕ 7.10 12.00

Description	Part Number	Color	Material	Wire O.D. Range
Cable Seal	7158-3110-40	Light Grey	Silicone	3.10 ~ 3.3
	7158-3111-60	Green	Silicone	1.19 ~ 1.9
	7158-3112-70	Yellow	Silicone	1.88 ~ 2.1
	7158-3113-40	White	Silicone	2.18 ~ 3.0
	7158-3115-80	Brown	Silicone	1.19 ~ 1.9
	7158-3116-50	Red	Silicone	1.88 ~ 2.4
Unused Cavity Plug	7158-3114-90	Blue	Silicone	N/A

2.8 x 0.8

sealed connection system

Retainer Clip/Bracket Dimensions

UNIT: mm

Technical drawings of the Retainer Clip/Bracket showing top, side, and perspective views with dimensions. The top view shows a rectangular shape with a total length of 10.005 mm, a width of 5.85 mm, and a notch width of 2.55 mm. The side view shows a height of 10.05 mm and a radius of R0.80. The perspective view shows a depth of 0.90 mm and a height of 2.40 mm. A table below the drawings provides part number and panel hole requirements.

Part Number	Panel Hole Requirements
7047-9580 (Ref.)	φ6.5mm

Part Number Summary Chart

Part Name	Male	Female
Terminal	7114-4150-02	7116-4150-02
	7114-4151-02	7116-4151-02
	7114-4152-02	7116-4152-02
Cable Seal	7158-3110-40	
	7158-3111-60	
	7158-3112-70	
	7158-3113-40	
	7158-3115-80	
	7158-3116-50	
Unused Cavity Plug	7158-3114-90	
Applicable Clip	N/A	7047-9580 (Ref)

Pole	Polarity	Color Description	Male Part #	Female Part #	Female Part # (w/CPA)
2	A	Dark Grey	7282-5575-10	7283-5575-10	7283-5922-10
3	A	Dark Grey	7282-5576-10	7283-5576-10	7283-5923-10
4	A	Dark Grey	7282-5570-10	7283-5570-10	7283-5924-10
4	B	Black	7282-5571-30	7283-5571-30	7283-5925-30
5	A	Black/Direct Only		7283-5918-30	
6	A	Dark Grey	7282-5577-10	7283-5577-10	7283-5926-10
8	A	Dark Grey	7282-5574-10	7283-5574-10	7283-5927-10

*Applicable Terminal Removal Tool/Dimensions









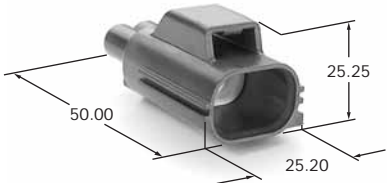

Refer to Page 68 for YES Connector Terminal Removal Tool.
Order Number: X39899-J374.

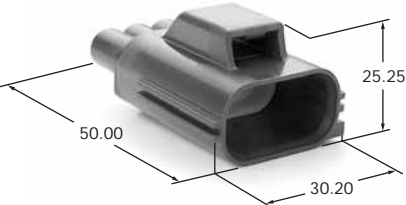
sealed connection system

2.8 x 0.8

Housing Material: HPA

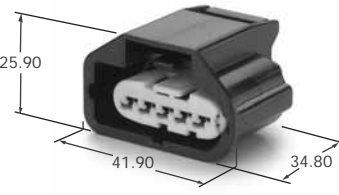
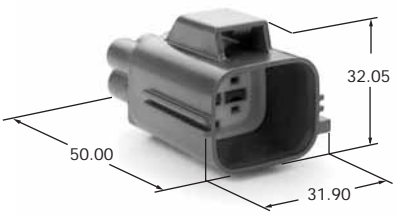
UNIT: mm



Poles	Male Housing	Female Housing
2	 <p>7282-5575-10</p>	 <p>7283-5575-10</p>
3	 <p>7282-5576-10</p>	 <p>7283-5576-10</p>
4	 <p>7282-5570-10</p>	 <p>7283-5570-10</p>
4	 <p>7282-5571-30</p>	 <p>7283-5571-30</p>
5	N/A	 <p>7283-5918-30</p>
6	 <p>7282-5577-10</p>	 <p>7283-5577-10</p>

2.8 x 0.8

sealed connection system

Housing Material: HPA

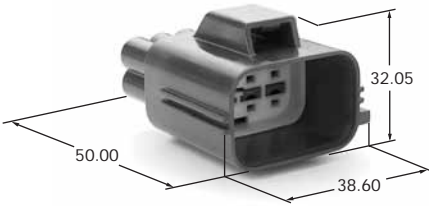
UNIT: mm

Poles	Male Housing	Female Housing
8	 <p data-bbox="600 646 764 680">7282-5574-10</p>	 <p data-bbox="1192 646 1355 680">7283-5574-10</p>

YESC

CONNECTORS

6.3 SERIES UNSEALED

CLICK ON YOUR SELECTION:

- CONSTRUCTION
- SPECIFICATIONS
- CURRENT RATING CURVE
- TERMINAL
- RETAINER CLIP/BRACKET DIMENSIONS
- PART NUMBER SUMMARY CHART
- PHOTOS/DIMENSIONS
- NAVIGATION TIPS

6.3 SERIES
UNSEALED

YAZAKI ENGINEERING STANDARD CONNECTORS

6.3 x 0.8

unsealed connection system

Construction

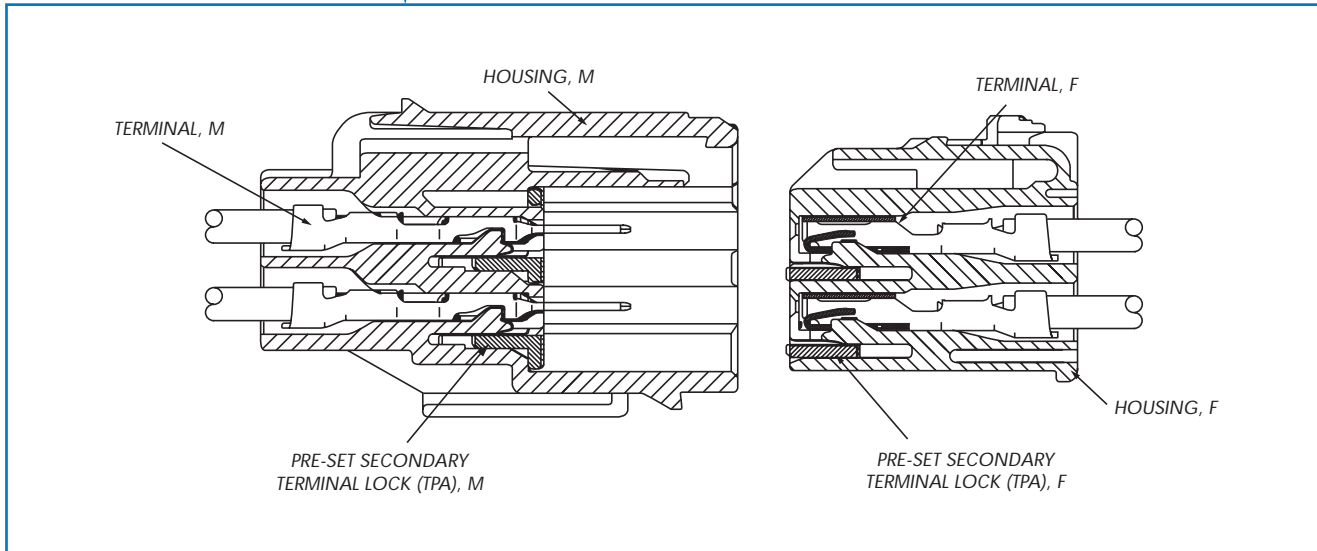

Specifications

Material	Connector	HPA
	Male Terminal	Copper Alloy (Sn Plate)
	Female Terminal	Copper Alloy (Sn Plate)
Operating Temperature Range		-40°C ~ 125°C (145°C max temp.) (USCAR Class III)
Current Capacity		(See Chart)
Voltage Drop		10mΩ Max (Term./Term.) (Crimp-To-Crimp)
Isolation Resistance		500VDC, 20MΩ Min
Dielectric Resistance		1000VAC (1 min.)
Applicable Wire Size		20AWG ~ 12AWG (0.50mm ² ~ 4.0mm ²)
Terminal Pitch		Horizontal: 8.50mm; Vertical: 7.30mm
Terminal-to-Connector Retention Force		90N Min
Connector-to-Connector Retention Force		110N Min

Current Rating Curve (Reference Only)

This data is based on single circuit/connector evaluation. Data should be used as reference only. Appropriate derating should be considered based upon specific application requirements.

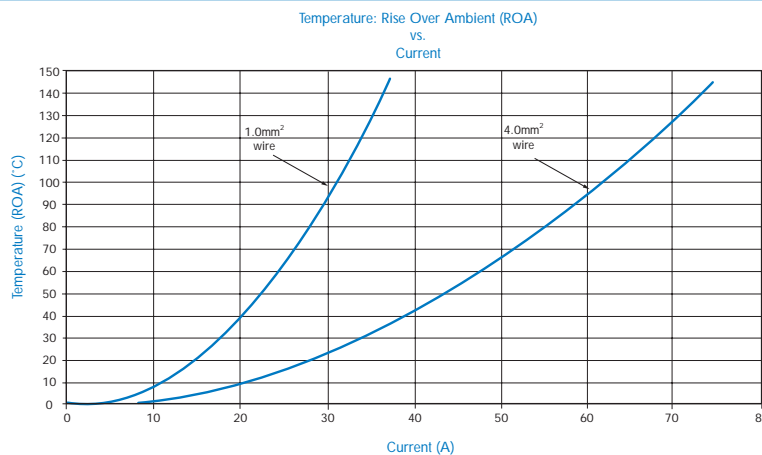

unsealed connection system

6.3 x 0.8

Terminal

UNIT: mm

Male Terminal

Material: Copper Alloy Thickness: t=0.4

Female Terminal

Material: Copper Alloy Thickness: t=0.4

Description	Part Number	Plating	Applicable Wire Size		
			Europe (mm ²)	U.S.A. (AWG)	Japan (mm ²)
Male Terminal	7114-4120-02	Sn	0.5 ~ 1.0	20 ~ 16	0.5 ~ 1.25
	7114-4121-02	Sn	1.5 ~ 2.5	14	2.0
	7114-4122-02	Sn	4.0	12	3.0
Female Terminal	7116-4120-02	Sn	0.5 ~ 1.0	20 ~ 16	0.5 ~ 1.25
	7116-4121-02	Sn	1.5 ~ 2.5	14	2.0
	7116-4122-02	Sn	4.0	12	3.0

Retainer Clip/Bracket Dimensions

UNIT: mm

Part Number	Panel Hole Requirements
7047-9580 (Ref.)	φ6.5mm

Part Number Summary Chart

Part Name	Male	Female	Pole	Polarity	Color	Male Part #	Female Part #	Female Part # (w/CPA)
Terminal	7114-4120-02	7116-4120-02	6	A	Light Grey	7282-5604-40	N/A	7283-5603-40
	7114-4121-02	7116-4121-02						
	7114-4122-02	7116-4122-02						
Applicable Clip	7047-9580 (Ref)	N/A						

*Applicable Terminal Removal Tool/Dimensions

Refer to Page 68 for YES Connector Terminal Removal Tool.
Order Number: G0406 (PA Type).

6.3 x 0.8

unsealed connection system

Housing Material: HPA

UNIT: mm

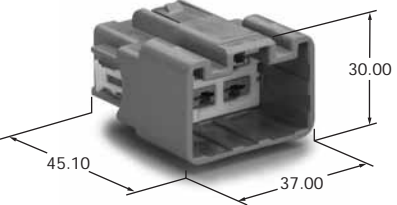
<i>Poles</i>	<i>Male Housing</i>	<i>Female Housing</i>
6	 <p>7282-5604-40</p>	<p>N/A Please check YESC KAIZEN Catalog for the mate.</p>

YESC

CONNECTORS

6.3

SERIES

SEALED

CLICK ON YOUR SELECTION:

- CONSTRUCTION
- SPECIFICATIONS
- CURRENT RATING CURVE
- TERMINAL
- CABLE SEAL
- RETAINER CLIP/BRACKET DIMENSIONS
- PART NUMBER SUMMARY CHART
- PHOTOS/DIMENSIONS
- NAVIGATION TIPS

6.3 SERIES
SEALED

6.3 x 0.8

sealed connection system

Construction

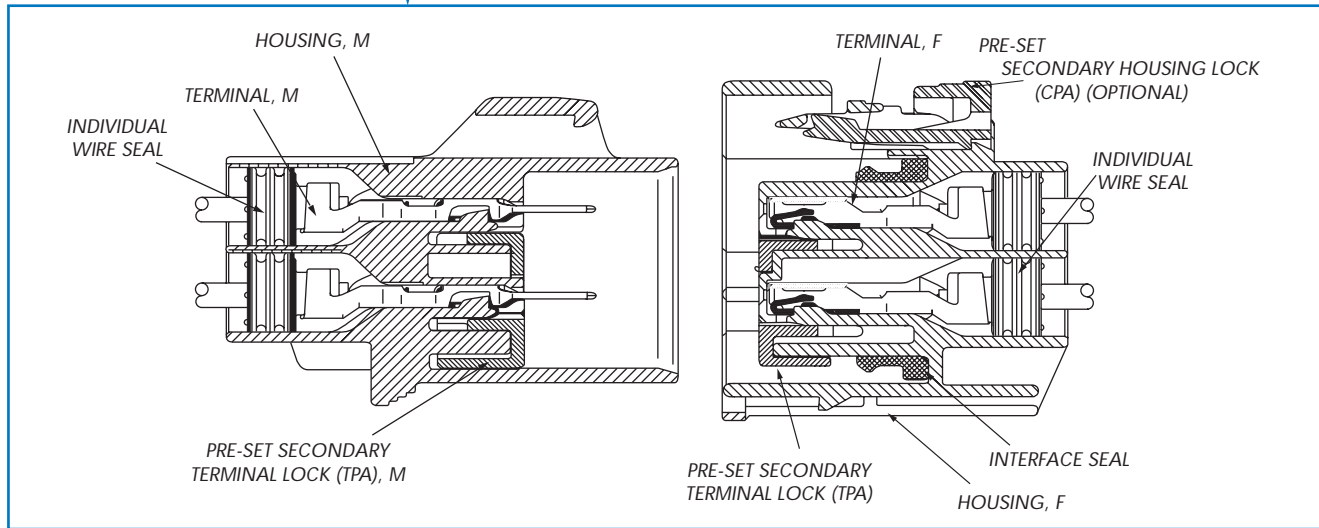

Specifications

Material	Connector	HPA
	Male Terminal	Copper Alloy (Sn Plate)
	Female Terminal	Copper Alloy (Sn Plate)
Operating Temperature Range		-40°C ~125°C (145°C max temp.) (USCAR Class III)
Current Capacity		(See Chart)
Voltage Drop		10mΩ Max (Term./Term.) (Crimp-To-Crimp)
Isolation Resistance		500VDC, 20MΩ Min
Dielectric Resistance		1000VAC (1 min.)
Applicable Wire Size		20AWG ~ 12AWG (0.50mm ² ~ 4.0mm ²)
Terminal Pitch		Horizontal: 9.80mm; Vertical: 9.80mm
Sealing Performance (Air Leak Pressure)		48kPa Min (Pre-Heat Soak); 28kPa (Post-Heat Soak)
Terminal-to-Connector Retention Force		90N Min
Connector-to-Connector Retention Force		110N Min

Current Rating Curve (Reference Only)

This data is based on single circuit/connector evaluation. Data should be used as reference only. Appropriate derating should be considered based upon specific application requirements.

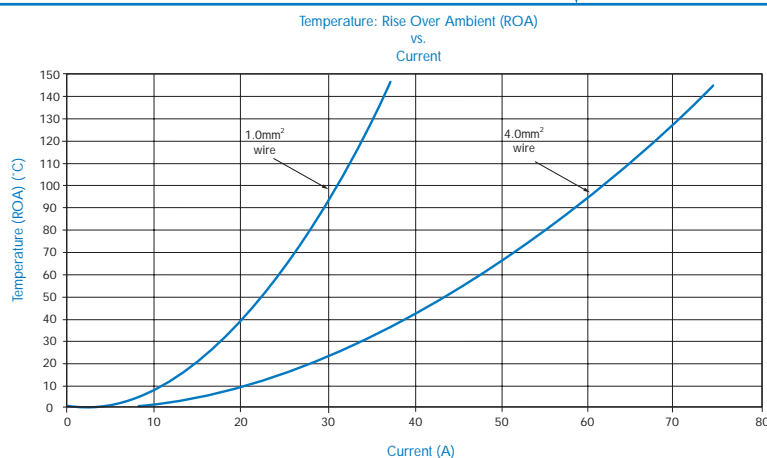

sealed connection system

6.3 x 0.8

Terminal

UNIT: mm

Male Terminal

Material: Copper Alloy Thickness: t=0.4

Female Terminal

Material: Copper Alloy Thickness: t=0.4

Description	Part Number	Plating	Applicable Wire Size		
			Europe (mm ²)	U.S.A. (AWG)	Japan (mm ²)
Male Terminal	7114-4140-02	Sn	0.5 ~ 1.0	20 ~ 16	0.5 ~ 1.25
	7114-4141-02	Sn	1.5 ~ 2.5	14	2.0
	7114-4142-02	Sn	4.0	12	3.0
Female Terminal	7116-4140-02	Sn	0.5 ~ 1.0	20 ~ 16	0.5 ~ 1.25
	7116-4141-02	Sn	1.5 ~ 2.5	14	2.0
	7116-4142-02	Sn	4.0	12	3.0

Cable Seal

UNIT: mm

Description	Part Number	Color	Material	Wire O.D. Range
Cable Seal	7158-3081-50	Red	Silicone	1.4 ~ 2.1
	7158-3082-90	Blue	Silicone	2.18 ~ 3.0
	7158-3083	Black	Silicone	3.1 ~ 3.7
Unused Cavity Plug	7158-3080-60	Green	Silicone	N/A

Retainer Clip/Bracket Dimensions

UNIT: mm

Part Number	Panel Hole Requirements
7047-9580 (Ref.)	φ6.5mm

6.3 x 0.8

sealed connection system



Part Number Summary Chart

Part Name	Male	Female
Terminal	7114-4140-02	7116-4140-02
	7114-4141-02	7116-4141-02
	7114-4142-02	7116-4142-02
Cable Seal	7158-3081-50	
	7158-3082-90	
	7158-3083	
Unused Cavity Plug	7158-3080-60	
Applicable Clip	N/A	7047-9580 (Ref)

Pole	Polarity	Color Description	Male Part #	Female Part #	Female Part # (w/CPA)	Delete Cap
2	A	Dark Grey	7282-5596-10	7283-5596-10	7283-5928-10	
4	A	Dark Grey	7282-5595-10		7283-5929-10	

Housing Material: HPA

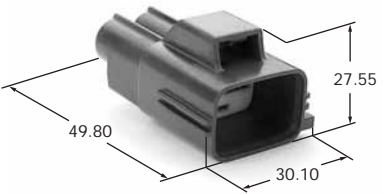
UNIT: mm

Poles	Male Housing	Female Housing
2	 <p>7282-5596-10</p>	 <p>7283-5596-10</p>
4	 <p>7282-5595-10</p>	<p>N/A</p> <p>Please check YESC KAIZEN Catalog for the mate.</p>

*Applicable Terminal Removal Tool/Dimensions

Refer to Page 81 for YES Connector Terminal Removal Tool.
Order Number: G0406 (PA Type).

YESC

CONNECTORS

Hybrid SERIES

CLICK ON YOUR SELECTION:

SPECIFICATIONS

TERMINAL

RETAINER CLIP/BRACKET DIMENSIONS

PART NUMBER SUMMARY CHART

PHOTOS/DIMENSIONS

NAVIGATION TIPS

HYBRID
SERIES

YAZAKI ENGINEERING STANDARD CONNECTORS

HYBRID

connection system

Specifications

Material	Connector	HPA
	Male Terminal	Copper Alloy (Sn/Au Plate)
	Female Terminal	Copper Alloy (Sn/Au Plate)
Operating Temperature Range		-40°C ~100°C (120°C max temp.) (USCAR Class II)
Operating Temperature Range		-40°C ~125°C (145°C max temp.) (USCAR Class III)
Current Capacity		(See Chart)
Voltage Drop		10mΩ Max (Term./Term.) (Crimp-To-Crimp)
Isolation Resistance		500VDC, 20MΩ Min
Dielectric Resistance		1000VAC (1 min.)
Applicable Wire Size		See Specific Connector Section
Terminal-to-Connector Retention Force		See Specific Connector Section
Connector-to-Connector Retention Force		See Specific Connector Section

Terminal

Description	Part Number	Plating	Applicable Wire Size			
			Europe (mm ²)	U.S.A. (AWG)	Japan (mm ²)	
Male Terminal	0.64mm	7114-4720-02/-08	0.35	22	0.3	
		7114-4721-02/-08	0.5 ~ 0.75	20 ~ 18	0.5 ~ 0.8	
	1.5mm	7114-4100-02/-08	0.35 ~ 0.5	22 ~ 20	0.3 ~ 0.5	
		7114-4101-02/-08	0.75 ~ 1.0	18 ~ 16	0.85 ~ 1.25	
	2.8mm	7114-4110-02	Sn	0.35 ~ 0.5	22 ~ 20	0.3 ~ 0.5
		7114-4111-02	Sn	0.75 ~ 1.0	18 ~ 16	0.85 ~ 1.25
		7114-4112-02	Sn	1.5 ~ 2.5	14	2.0
	6.3mm	7114-4120-02	Sn	0.5 ~ 1.0	20 ~ 16	0.5 ~ 1.25
		7114-4121-02	Sn	1.5 ~ 2.5	14	2.0
		7114-4122-02	Sn	4.0	12	3.0
	Female Terminal	0.64mm	7116-4720-02/-08	0.35	22	0.3
			7116-4721-02/-08	0.5 ~ 0.75	20 ~ 18	0.5 ~ 0.8
1.5mm		7116-4100-02/-08	Sn/Au	0.35 ~ 0.5	22 ~ 20	0.3 ~ 0.5
		7116-4101-02/-08	Sn/Au	0.75 ~ 1.0	18 ~ 16	0.85 ~ 1.25
2.8mm		7116-4110-02	Sn	0.35 ~ 0.5	22 ~ 20	0.3 ~ 0.5
		7116-4111-02	Sn	0.75 ~ 1.0	18 ~ 16	0.85 ~ 1.25
		7116-4112-02	Sn	1.5 ~ 2.5	14	2.0
6.3mm		7116-4120-02	Sn	0.5 ~ 1.0	20 ~ 16	0.5 ~ 1.25
		7116-4121-02	Sn	1.5 ~ 2.5	14	2.0
		7116-4122-02	Sn	4.0	12	3.0

connection system

HYBRID

Retainer Clip/Bracket Dimensions

UNIT: mm

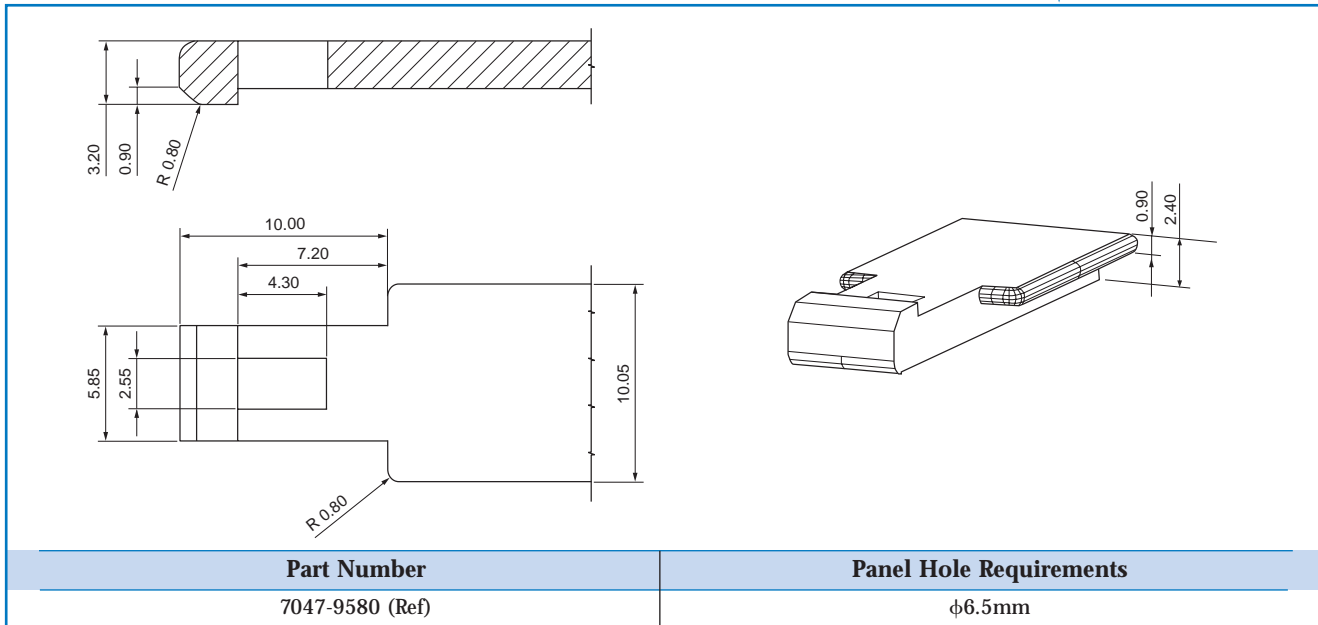

Part Number Summary Chart

Part Name	Male	Female	
Terminal	0.64mm	7114-4720-02	7116-4720-02
		7114-4721-02	7116-4721-02
		7114-3286-08	7116-4721-08
		7114-3287-08	7116-4721-08
	1.5mm	7114-4100-02/-08	7116-4100-02/-08
		7114-4101-02/-08	7116-4101-02/-08
	2.8mm	7114-4110-02	7116-4110-02
		7114-4111-02	7116-4111-02
		7114-4112-02	7116-4112-02
	6.3mm	7114-4120-02	7116-4120-02
		7114-4121-02	7116-4121-02
		7114-4122-02	7116-4122-02
Applicable Clip	7047-9580 (Ref)	N/A	

HYBRID

connection system

Part Number
Summary Chart (cont.)

Pole	Polarity	Color/Description	Male Part #	Female Part #	Female Part # w/(CPA)
3	A	Light Grey 1x1.5, 2x6.3	7282-5628-40	7283-5628-40	
10	A	Light Grey 6x1.5, 4x2.8			7283-5637-40
13	A	Light Grey 11x2.8, 2x6.3	7282-5625-40	7283-5625-40	7283-5643-40
14	A	Light Grey 10x1.5, 4x2.8			7283-5639-40
14	B	Green 10x1.5, 4x2.8	7282-5623-60	7283-5623-60	
14	B	Black 10x1.5, 4x2.8	7282-5623-30	7283-5623-30	
14	C	Blue 10x1.5, 4x2.8	7282-5624-90	7283-5624-90	
14	C	Brown 10x1.5, 4x2.8	7282-5624-80	7283-5624-80	

Housing Material: HPA

UNIT: mm

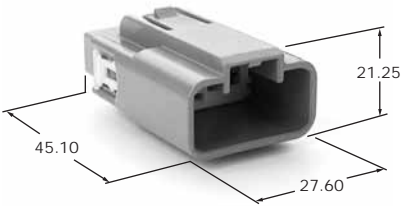
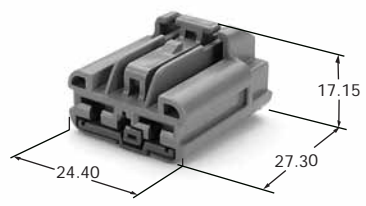
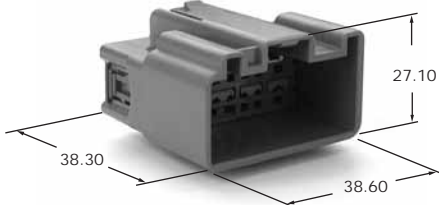
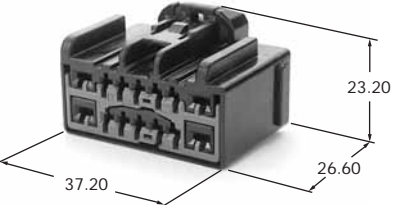
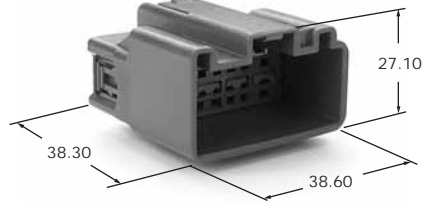
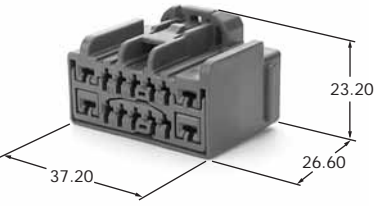
Poles	Male Housing	Female Housing
3	 <p>7282-5628-40</p>	 <p>7283-5628-40</p>
14	 <p>7282-5623-60</p>	 <p>7283-5623-60</p>
14	 <p>7282-5624-90</p>	 <p>7283-5624-90</p>

*Applicable Terminal Removal Tool/Dimensions

Refer to Page 68 for YES Connector Terminal Removal Tool. Order Number: 49YA00105 (for 0.64 terminal), X39899-J374 (for 1.5 and 2.8 terminal) and G0406 (PA Type) (for 6.3 terminal).

YESC

CONNECTORS

Header SERIES

CLICK ON YOUR SELECTION:

CONSTRUCTION
SPECIFICATIONS
CURRENT RATING CURVE
TERMINAL
PART NUMBER SUMMARY CHART
PHOTOS/DIMENSIONS
NAVIGATION TIPS

HEADER
SERIES

YAZAKI ENGINEERING STANDARD CONNECTORS

HEADER

connection system

Construction

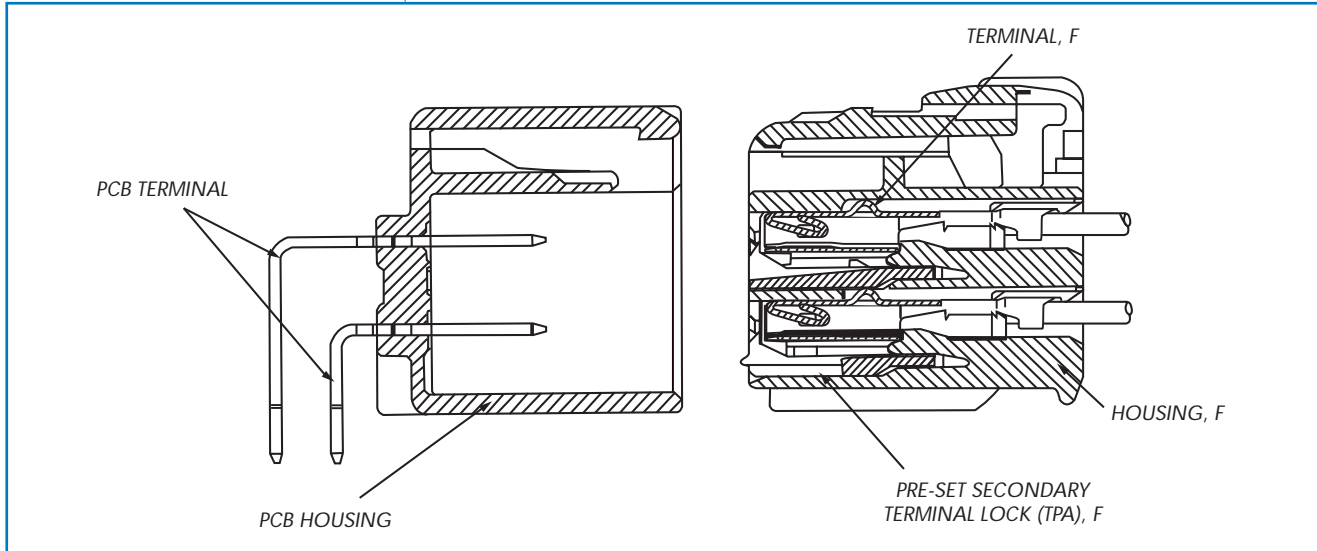

Specifications

Material	Connector	See Section
	Male Terminal	Brass
	Female Terminal	Copper Alloy (Sn/Au Plate)
Operating Temperature Range		-40°C ~100°C (125°C max temp.) (USCAR Class II)
Current Capacity		(See Chart)
Voltage Drop		10mΩ Max (Term./Term.)
Isolation Resistance		500VDC, 20MΩ Min
Dielectric Resistance		1000VAC (1 min.)
Terminal-to-Connector Retention Force		90N Min
Connector-to-Connector Retention Force		110N Min

Current Rating Curve

SEE APPLICABLE BLADE SIZE SECTION

connection system

HEADER

Terminal

UNIT: mm

<i>Male PCB Terminal</i>			<i>Female Terminal</i>			
PURCHASED IN ASSEMBLY			SEE APPLICABLE BLADE SIZE SECTION			
<i>Material: Brass</i>			<i>Material: Copper Alloy</i>		<i>Thickness: t=0.3</i>	
Description	Part Number	Plating	Applicable Wire Size			
			Europe (mm ²)	U.S.A. (AWG)	Japan (mm ²)	
<i>Male Terminal</i>	N/A					
<i>Female Terminal</i>	1.5mm	7116-4100-02	Sn	0.35 ~ 0.5	22 ~ 20	0.3 ~ 0.5
		7116-4101-02	Sn	0.75 ~ 1.0	18 ~ 16	0.85 ~ 1.25
		7116-4100-08	Au	0.35 ~ 0.5	22 ~ 20	0.3 ~ 0.5
		7116-4101-08	Au	0.75 ~ 1.0	18 ~ 16	0.85 ~ 1.25
	2.8mm	7116-4110-02	Sn	0.35 ~ 0.5	22 ~ 20	0.3 ~ 0.5
		7116-4111-02	Sn	0.75 ~ 1.0	18 ~ 16	0.85 ~ 1.25
		7116-4112-02	Sn	1.5 ~ 2.5	14	2.0
	6.3mm	7116-4120-02	Sn	0.5 ~ 1.0	20 ~ 16	0.5 ~ 1.25
		7116-4121-02	Sn	1.5 ~ 2.5	14	2.0
	7116-4122-02	Sn	4.0	12	3.0	

HEADER

connection system

Part Number Summary Chart

Part Name		Male	Female
Terminal	1.5mm	N/A	7116-4100-02
		N/A	7116-4101-02
		N/A	7116-4100-08
		N/A	7116-4101-08
	2.8mm	N/A	7116-4110-02
		N/A	7116-4111-02
		N/A	7116-4112-02
	6.3mm	N/A	7116-4120-02
		N/A	7116-4121-02
		N/A	7116-4122-02

Pole	Polarity	Color/Description	Male Part #	YESC KAIZEN Female Part #	Female Part # w/(CPA)
2	A	Light Grey 6.3mm Header	7382-5597-40	7283-6458-40	7283-5601-40
2	A	Black 6.3mm Header	7382-5608-30	7283-6458-40	7283-5601-40
10	A	Light Grey 1.5mm Header	7382-5884-40	7283-6455-40	7283-5909-40
10	B	Black 1.5mm Header	7382-6379-30	7283-6455-40	7283-5909-40
12	A	Light Grey 2.8mm H-Header	7382-5568-40	7283-6467-40	7283-5916-40
12	A	Black 1.5mm Header	7382-5957-30	7382-5957-30	7283-5940-40
14	A	Light Grey Hybrid 10x1.5, 4x2.8	7382-5627-40	7283-6447-40	7283-5639-40
16	A	Green/Config 1 1.5mm Header	7382-5551-60	7283-6453-60	7283-5941-60
16	A	Green/Config 2 1.5mm Header	7382-5681-60	7283-6453-60	
16	A	Green/Config 3 1.5mm Header	7382-5682-60	7283-6453-60	
32	A	Black 1.5mm Header	7382-5552-30	7283-6456-90	
				7283-3585-40	
32	B	Light Grey 1.5mm Header	7382-5881-40	7283-6456-90	
				7283-3585-40	

*Applicable Terminal Removal Tool/Dimensions

Refer to Page 68 for YES Connector Terminal Removal Tool.

Order Number: X39899-J374 (for 1.5 and 2.8 terminal) and G0406 (PA Type) (for 6.3 terminal).



connection system

HEADER

Housing Material: PPA-GF16

Material: HPA

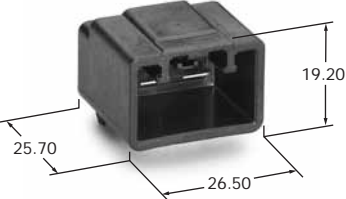
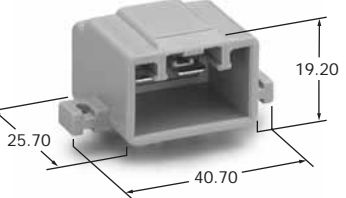
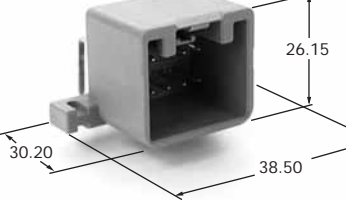
UNIT: mm

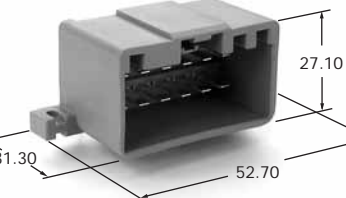
Poles	Male Housing	Female Housing
2	 <p>7382-5608-30</p>	SEE YESC KAIZEN CATALOG FOR MATES
2	 <p>7382-5597-40</p>	SEE YESC KAIZEN CATALOG FOR MATES
10	 <p>7382-5884-40</p>	SEE YESC KAIZEN CATALOG FOR MATES
10	 <p>7382-6379-30</p>	SEE YESC KAIZEN CATALOG FOR MATES
12	 <p>7382-5957-30</p>	SEE YESC KAIZEN CATALOG FOR MATES
12	 <p>7382-5568-40</p>	SEE YESC KAIZEN CATALOG FOR MATES

HEADER

connection system

Housing Material: PPA-GF16

Material: HPA

UNIT: mm

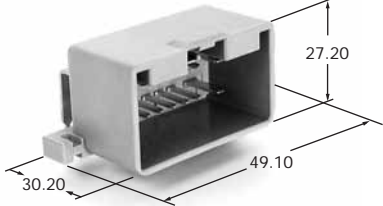
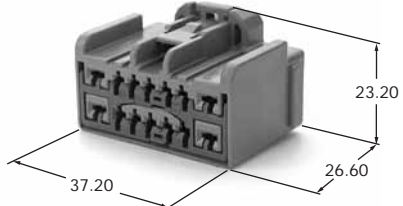
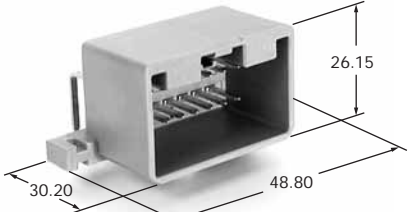
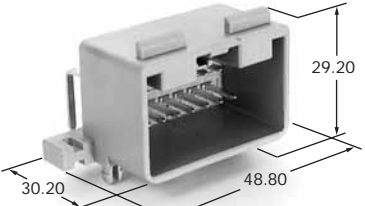
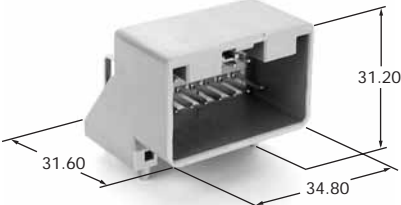
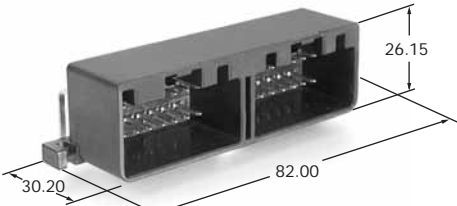
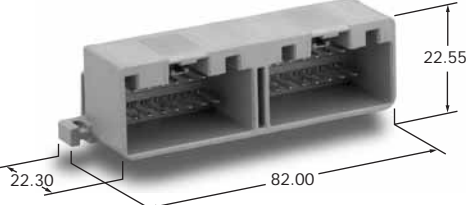
Poles	Male Housing	Female Housing
14	 <p>7382-5627-40</p>	 <p>7283-5622-40</p>
16	 <p>7382-5551-60</p>	SEE YESC KAIZEN CATALOG FOR MATES
16	 <p>7382-5681-60</p>	SEE YESC KAIZEN CATALOG FOR MATES
16	 <p>7382-5682-60</p>	SEE YESC KAIZEN CATALOG FOR MATES
32	 <p>7382-5552-30</p>	SEE YESC KAIZEN CATALOG FOR MATES
32	 <p>7382-5881-40</p>	SEE YESC KAIZEN CATALOG FOR MATES

YESC

CONNECTORS

Specialty

SERIES

UNSEALED

CLICK ON YOUR SELECTION:

SPECIFICATIONS

TERMINAL

PART NUMBER SUMMARY CHART

PHOTOS/DIMENSIONS

NAVIGATION TIPS



SPECIALTY
SERIES
UNSEALED

YAZAKI ENGINEERING STANDARD CONNECTORS

SPECIALTY SERIES unsealed connection system

Specifications

Material	Connector	HPA
	Male Terminal	Copper Alloy (Sn/Au Plate)
	Female Terminal	Copper Alloy (Sn/Au Plate)
Operating Temperature Range		-40°C ~100°C (120°C max temp.) (USCAR Class II)
Operating Temperature Range		-40°C ~125°C (145°C max temp.) (USCAR Class III)
Current Capacity		(See Chart)
Voltage Drop		10mΩ Max (Term./Term.) (Crimp-To-Crimp)
Isolation Resistance		500VDC, 20MΩ Min
Dielectric Resistance		1000VAC (1 min.)
Applicable Wire Size		See Specific Connector Section
Terminal-to-Connector Retention Force		See Specific Connector Section
Connector-to-Connector Retention Force		See Specific Connector Section

Terminal

Description	Part Number	Plating	Applicable Wire Size			
			Europe (mm ²)	U.S.A. (AWG)	Japan (mm ²)	
Male Terminal	0.64mm	7114-4720-02	Sn	0.35	22	0.3
		7114-4721-02	Sn	0.5 ~ 0.75	20 ~ 18	0.5 ~ 0.8
		7114-3286-08	Au	0.35	22	0.3
		7114-3287-08	Au	0.5 ~ 0.75	20 ~ 18	0.5 ~ 0.8
	1.5mm	7114-4100-02/-08	Sn/Au	0.35 ~ 0.5	22 ~ 20	0.3 ~ 0.5
		7114-4101-02/-08	Sn/Au	0.75 ~ 1.0	18 ~ 16	0.85 ~ 1.25
	2.8mm	7114-4110-02	Sn	0.35 ~ 0.5	22 ~ 20	0.3 ~ 0.5
		7114-4111-02	Sn	0.75 ~ 1.0	18 ~ 16	0.85 ~ 1.25
		7114-4112-02	Sn	1.5 ~ 2.5	14	2.0
	6.3mm	7114-4120-02	Sn	0.5 ~ 1.0	20 ~ 16	0.5 ~ 1.25
		7114-4121-02	Sn	1.5 ~ 2.5	14	2.0
		7114-4122-02	Sn	4.0	12	3.0
Female Terminal	0.64mm	7116-4720-02/-08	Sn/Au	0.35	22	0.3
		7116-4721-02/-08	Sn/Au	0.5 ~ 0.75	20 ~ 18	0.5 ~ 0.8
	1.5mm	7116-4100-02/-08	Sn/Au	0.35 ~ 0.5	22 ~ 20	0.3 ~ 0.5
		7116-4101-02/-08	Sn/Au	0.75 ~ 1.0	18 ~ 16	0.85 ~ 1.25
	2.8mm	7116-4110-02	Sn	0.35 ~ 0.5	22 ~ 20	0.3 ~ 0.5
		7116-4111-02	Sn	0.75 ~ 1.0	18 ~ 16	0.85 ~ 1.25
		7116-4112-02	Sn	1.5 ~ 2.5	14	2.0
	6.3mm	7116-4120-02	Sn	0.5 ~ 1.0	20 ~ 16	0.5 ~ 1.25
		7116-4121-02	Sn	1.5 ~ 2.5	14	2.0
		7116-4122-02	Sn	4.0	12	3.0

unsealed connection system **SPECIALTY SERIES**

Part Number Summary Chart

Part Name	Male	Female	
Terminal	0.64mm	7114-4720-02	7116-4720-02
		7114-4721-02	7116-4721-02
		7114-3286-08	7116-4720-08
		7114-3287-08	7116-4721-08
	1.5mm	7114-4100-02/-08	7116-4100-02/-08
		7114-4101-02/-08	7116-4101-02/-08
	2.8mm	7114-4110-02	7116-4110-02
		7114-4111-02	7116-4111-02
		7114-4112-02	7116-4112-02
	6.3mm	7114-4120-02	7116-4120-02
		7114-4121-02	7116-4121-02
		7114-4122-02	7116-4122-02
Applicable Clip	7047-9580 (Ref)	N/A	

Specialty	Pole	Polarity	Color/Description	Male Part #	Female Part #	Wire Shield
Axial Adjustable	12	A	Black 12x1.5	7282-4848-30	7283-4848-30	
Bolt Assist	26	A	Black 20x2.8, 6x6.3/HPA		7283-5631-30	
	26	B	Light Grey 20x2.8, 6x6.3/HPA		7283-5632-40	
	36	A	Black 20x1.5, 12x2.8, 4x6.3/PBT		7283-4846-30	7134-4691
	68	A	Black 56x1.5, 8x2.8, 4x6.3/PBT		7283-4847-30	7134-4692
LIF	15	A	Black 9x2.8, 6x6.3	N/A	7283-6372-30	
	15	B	Natural 9x2.8, 6x6.3	N/A	7283-6373	
	26	A	Light Grey 22x1.5, 2x2.8, 2x6.3	N/A	7283-6436-40	
	26	B	Blue 22x1.5, 2x2.8, 2x6.3	N/A	7283-6437-90	
	26	C	Green 22x1.5, 2x2.8, 2x6.3	N/A	7283-6438-60	
	26	A	Black 22x1.5, 2x2.8, 2x6.3	7282-6376-30	7283-6376-30	
	26	A	Black 22x1.5, 2x2.8, 2x6.3	7282-6537-30	7283-6537-30	
	26	B	Natural 22x1.5, 2x2.8, 2x6.3	7282-8390	7283-8390	
	26	C	Light Grey 22x1.5, 2x2.8, 2x6.3	7282-8391-40	7283-8391-40	
	26	D	Green 22x1.5, 2x2.8, 2x6.3	7282-8392-60	7283-8392-60	
	26	E	Brown 22x1.5, 2x2.8, 2x6.3	7282-8393-80	7283-8393-80	

***Applicable Terminal Removal Tool/Dimensions**



Refer to Page 70-71 for YES Connector Terminal Removal Tool.

Order Number: 49YA00105 (for 0.64 terminal), X39899-J374 (for 1.5 and 2.8 terminal) and G0406 (PA Type) (for 6.3 terminal).

SPECIALTY SERIES unsealed connection system

Axial Adjustable Housing Material: PBT

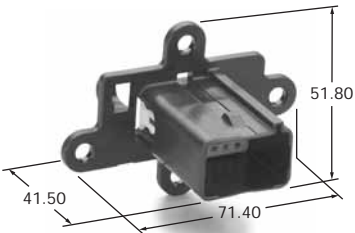
UNIT: mm

Poles	Male Housing	Female Housing
12	 <p>7282-4848-30</p>	 <p>7283-4848-30</p>

Bolt Assist Housing Material: HPA/PBT

UNIT: mm

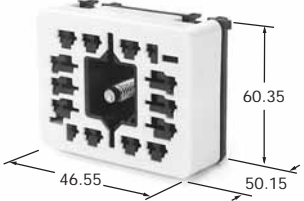
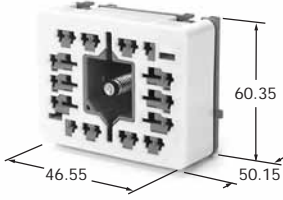
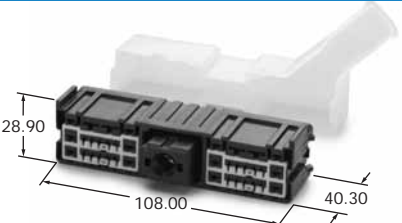
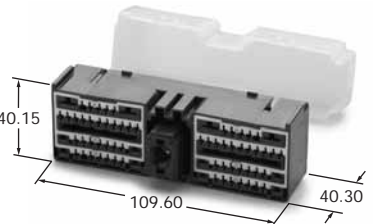
Poles	Male Housing	Female Housing
26	N/A	 <p>7283-5631-30</p>
26	N/A	 <p>7283-5632-40</p>
36	N/A	 <p>7283-4846-30</p>
68	N/A	 <p>7283-4847-30</p>

unsealed connection system **SPECIALTY SERIES**

LIF
Housing Material: PBT

UNIT: mm

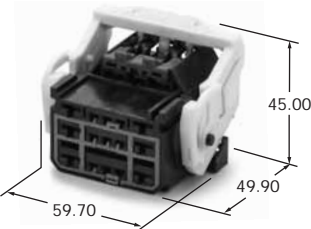
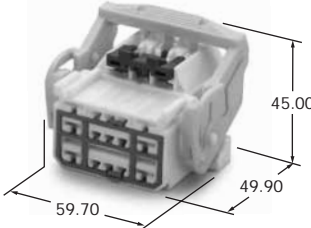
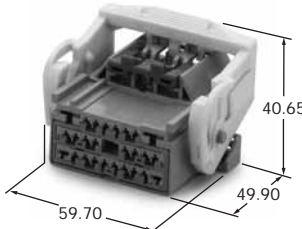
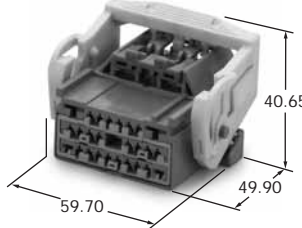
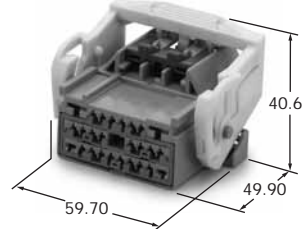
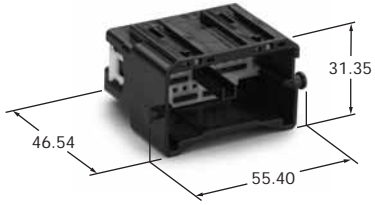
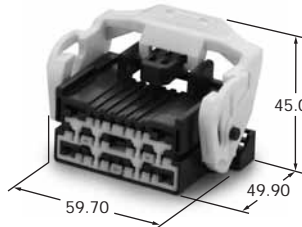
Poles	Male Housing	Female Housing
15	N/A	 <p>7283-6372-30</p>
15	N/A	 <p>7283-6373</p>
26	N/A	 <p>7283-6436-40</p>
26	N/A	 <p>7283-6437-90</p>
26	N/A	 <p>7283-6438-60</p>
26	 <p>7282-6376-30</p>	 <p>7283-6376-30</p>

YESC

CONNECTORS

Specialty

SERIES

SEALED

CLICK ON YOUR SELECTION:

SPECIFICATIONS

TERMINAL

CABLE SEAL

PART NUMBER SUMMARY CHART

PHOTOS/DIMENSIONS

NAVIGATION TIPS

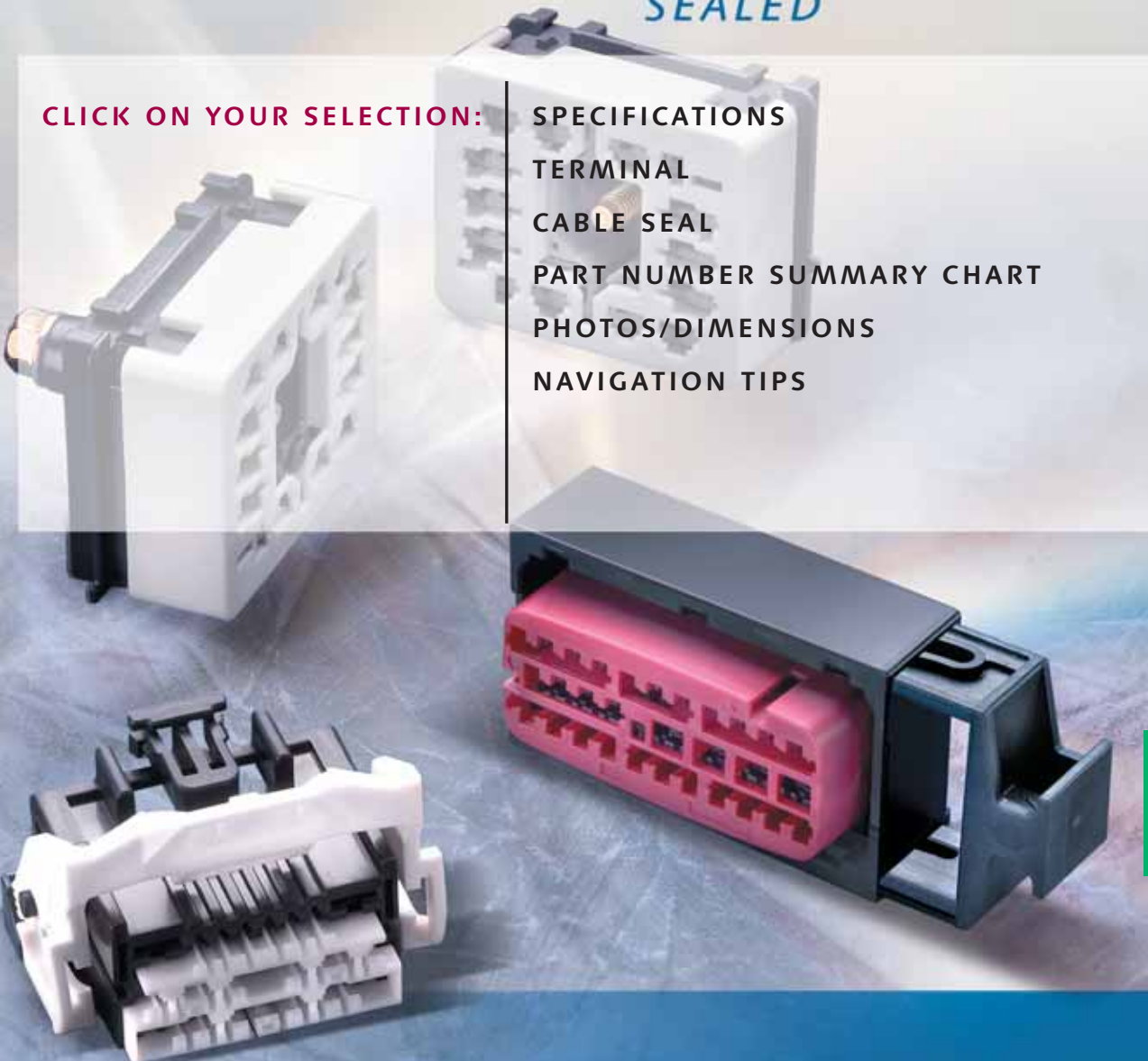

SPECIALTY
SERIES
SEALED

YAZAKI ENGINEERING STANDARD CONNECTORS

SPECIALTY SERIES

sealed connection system

Specifications

Material	Connector	See Section
	Male Terminal	Copper Alloy (Sn Plate)
	Female Terminal	Copper Alloy (Sn Plate)
Operating Temperature Range		-40°C ~125°C (145°C max temp.) (USCAR Class III)
Isolation Resistance		500VDC, 20MΩ Min
Dielectric Resistance		1000VAC (1 min.)
Applicable Wire Size		22AWG ~ 16AWG (0.35mm ² ~ 1.0mm ²)
Terminal Pitch		Horizontal: 5.50mm; Vertical: N/A
Sealing Performance (Air Leak Pressure)		48kPa Min (Pre-Heat Soak); 28kPa (Post-Heat Soak)
Terminal-to-Connector Retention Force		90N Min
Connector-to-Connector Retention Force		110N Min

Terminal

Description	Part Number	Plating	Applicable Wire Size			
			Europe (mm ²)	U.S.A. (AWG)	Japan (mm ²)	
Male Terminal	0.64mm	7114-4720-02	Sn	0.35	22	0.3
		7114-4721-02	Sn	0.5 ~ 0.75	20 ~ 18	0.5 ~ 0.8
		7114-3286-08	Au	0.35	22	0.3
		7114-3287-08	Au	0.5 ~ 0.75	20 ~ 18	0.5 ~ 0.8
	1.5mm	7114-4102-02/-08	Sn/Au	0.35 ~ 0.5	22 ~ 20	0.3 ~ 0.5
		7114-4103-02/-08	Sn/Au	0.75 ~ 1.0	18 ~ 16	0.85 ~ 1.25
	2.8mm	7114-4150-02	Sn	0.35 ~ 0.5	22 ~ 20	0.3 ~ 0.5
		7114-4151-02	Sn	0.75 ~ 1.0	18 ~ 16	0.85 ~ 1.25
		7114-4152-02	Sn	1.5 ~ 2.5	14	2
	6.3mm	7114-4140-02	Sn	0.5 ~ 1.0	20 ~ 16	0.5 ~ 1.25
		7114-4141-02	Sn	1.5 ~ 2.5	14	2.0
		7114-4142-02	Sn	4.0	12	3.0
Female Terminal	0.64mm	7116-4720-02/-08	Sn/Au	0.35	22	0.3
		7116-4721-02/-08	Sn/Au	0.5 ~ 0.75	20 ~ 18	0.5 ~ 0.85
	1.5mm	7116-4102-02/-08	Sn/Au	0.35 ~ 0.5	22 ~ 20	0.3 ~ 0.5
		7116-4103-02/-08	Sn/Au	0.75 ~ 1.0	18 ~ 16	0.85 ~ 1.25
	2.8mm	7116-4150-02	Sn	0.35 ~ 0.5	22 ~ 20	0.3 ~ 0.5
		7116-4151-02	Sn	0.75 ~ 1.0	18 ~ 16	0.85 ~ 1.25
		7116-4152-02	Sn	1.5 ~ 2.5	14	2.0
	6.3mm	7116-4140-02	Sn	0.5 ~ 1.0	20 ~ 16	0.5 ~ 1.25
		7116-4141-02	Sn	1.5 ~ 2.5	14	2.0
		7116-4142-02	Sn	4.0	12	3.0

sealed connection system

SPECIALTY SERIES

Lamp Socket Cable Seal

UNIT: mm

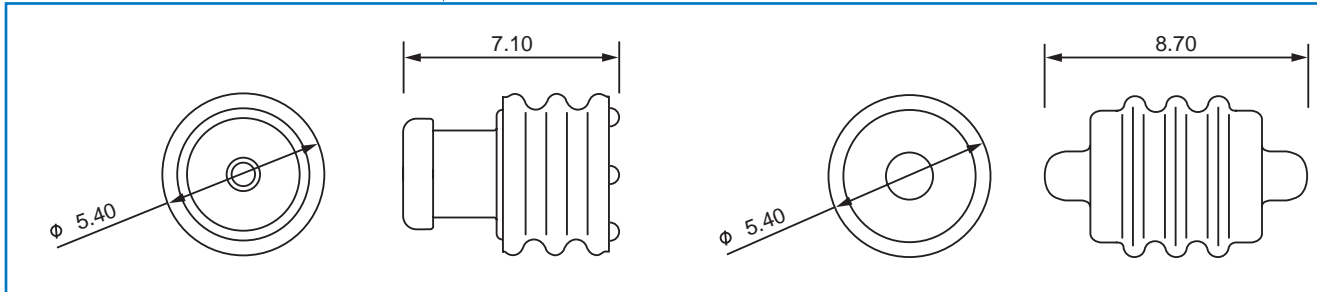

Description	Part Number	Color	Material	Wire O.D. Range
Cable Seal (Female Only)	7158-3030-50	Red	Silicone	1.19 ~ 1.70
	7158-3031-90	Blue	Silicone	1.60 ~ 2.34
Unused Cavity Plug	7158-3032-60	Green	Silicone	N/A

SPECIALTY SERIES

sealed connection system

Part Number Summary Chart

Part Name		Male	Female
Terminal	0.64mm	7114-4720-02	7116-4720-02
		7114-4721-02	7116-4721-02
		7114-3286-08	7116-4720-08
		7114-3287-08	7116-4721-08
	1.5mm	7114-4102-02/-08	7116-4102-02/-08
		7114-4103-02/-08	7116-4103-02/-08
	2.8mm	7114-4150-02	7116-4150-02
		7114-4151-02	7116-4151-02
		7114-4152-02	7116-4152-02
	6.3mm	7114-4140-02	7116-4140-02
7114-4141-02		7116-4141-02	
	7114-4142-02	7116-4142-02	
Cable Seal	Lamp Socket	7158-3030-50	
		7158-3031-90	
Unused Cavity Plug	Lamp Socket	7158-3032-60	

Specialty	Pole	Polarity	Color/Description	Male Part #	Female Part #
CAM Lever	30		Black #7, #9-11, #17-19 & #26-28 Pin Neg.	N/A	7283-5635-30
	30		Black	N/A	7283-5810-30
	30		Black	N/A	7283-5875-30
Lamp Socket	2	A	Axial 1.5mm	7341-5270-40	7283-5689-30
	2	A	Right Angle 1.5mm	7341-5271-40	7283-5689-30
	2	A	Axial 1.5mm	7341-5272-40	7283-5689-30
Fuel Injector	2		Black 1.5mm/PBT	N/A	N/A
	2		Black 1.5mm/HPA	N/A	7283-6430-30
	2		Black 1.5mm/HPA	N/A	7283-6647-30
	2		Black 1.5mm/PBT	N/A	7283-8492-30

***Applicable Terminal Removal Tool/Dimensions**

Refer to Page 70-71 for YES Connector Terminal Removal Tool.
 Order Number: 49YA00105 (for 0.64 terminal), X39899-J374 (for 1.5 and 2.8 terminal) and G0406 (PA Type) (for 6.3 terminal).

sealed connection system

SPECIALTY SERIES

CAM Lever
Housing Material: HPA

UNIT: mm

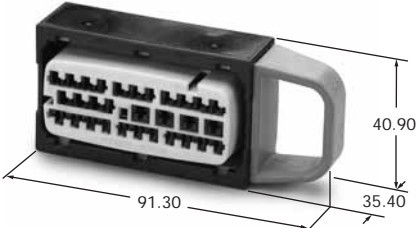
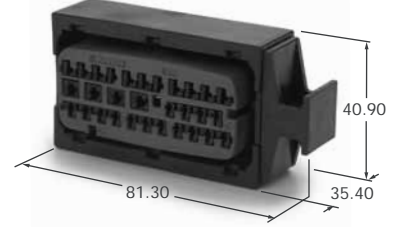
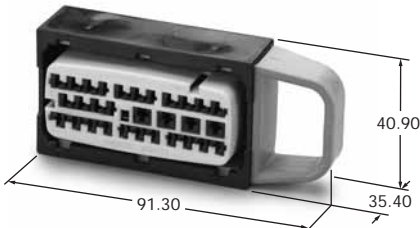
Poles	Male Housing	Female Housing
30	N/A	 <p>7283-5635-30</p>
30	N/A	 <p>7283-5810-30</p>
30	N/A	 <p>7283-5875-30</p>

SPECIALTY SERIES

sealed connection system

Lamp Socket Nylon
Housing Material: PA66

Material: HPA

UNIT: mm

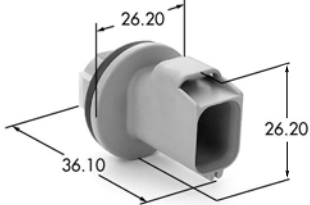
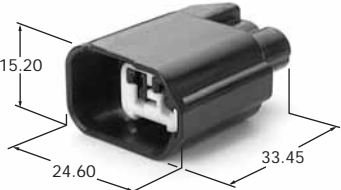
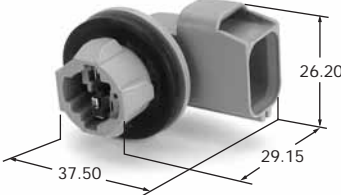
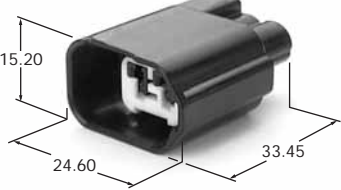
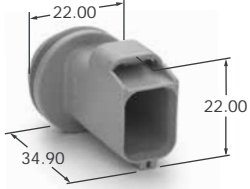
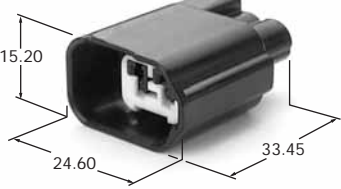

Poles	Male Housing	Female Housing
2	 <p>7341-5270-40</p>	 <p>7283-5689-30</p>
2	 <p>7341-5271-40</p>	 <p>7283-5689-30</p>
2	 <p>7341-5272-40</p>	 <p>7283-5689-30</p>

sealed connection system

SPECIALTY SERIES

Fuel Injector Housing Material: PBT/HPA

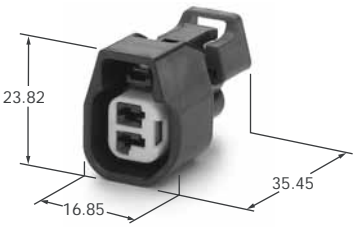
UNIT: mm

Poles	Male Housing	Female Housing
2	N/A	 <p>7283-6430-30</p>
2	N/A	 <p>7283-6647-30</p>
2		 <p>7283-8492-30</p>



BACK TO YESC
CONTENTS MENU

CONNECTORS

Terminal REMOVAL

CLICK ON YOUR SELECTION:

TOOL FOR 0.64 SERIES

TOOL FOR 1.5 AND 2.8 SERIES

TOOL FOR 6.3 AND 9.5 SERIES

NAVIGATION TIPS



TERMINAL
REMOVAL

YAZAKI ENGINEERING STANDARD CONNECTORS

TERMINAL REMOVAL

Applicable Terminal Removal Tool/Dimensions

UNIT: mm

Description	Order Number
YES Connector Terminal Removal Tool for 0.64 series.	49YA000105

UNIT: mm

Description	Order Number
YES Connector Terminal Removal Tool for 1.5 and 2.8 series.	X39899-J374

UNIT: mm

Description	Order Number
YES Connector Terminal Removal Tool for 6.3 series.	G0406 (PA Type)

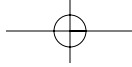

[BACK TO MAIN MENU](#)

YESC KAIZEN

CONNECTORS

CONTENTS

CLICK ON YOUR SELECTION:

[OVERVIEW](#)

[SYSTEM FEATURES](#)

[0.64 x 0.64 UNSEALED](#)

[0.64 x 0.64 SEALED](#)

[0.64 SERIES](#)

[1.5 x 0.8 UNSEALED](#)

[1.5 SERIES](#)

[2.8 x 0.8 UNSEALED](#)

[2.8 SERIES](#)

[6.3 x 0.8 UNSEALED](#)

[6.3 SERIES](#)

[9.5 x 1.2 SEALED](#)

[9.5 SERIES](#)

[HYBRID](#)

[HYBRID
SERIES](#)

[HEADER](#)

[HEADER
SERIES](#)

[TERMINAL REMOVAL](#)

[TERMINAL
REMOVAL](#)

[PART NUMBERING METHODOLOGY](#)

[YAZAKI LOCATIONS](#)

[DISCLAIMER](#)

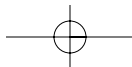

THE YESC KAIZEN CONNECTION

YESC KAIZEN stands for continuous improvement – the heart of a tradition that's helped make Yazaki the world's largest supplier of vehicle power and data networks, and related components. Now we've extended that tradition, combining Yazaki quality standards with highly cost-efficient engineering, to create the new YESC KAIZEN connector series. The latest addition to the Yazaki Engineering Standard Connectors (YESC) line, YESC KAIZEN connectors help engineers meet the aggressive performance, cost, and serviceability requirements of today's more capable, feature-rich vehicles. When it comes to continuous improvement in connectors, look to YESC KAIZEN from Yazaki.



YESC KAIZEN CONNECTORS

BACK TO YESC KAIZEN
CONTENTS MENU

SYSTEM FEATURES

- Popular-Size Sealed and Unsealed Connectors Available Immediately**
 The YESC KAIZEN connector series includes a full range of sealed and unsealed connector styles in stock, available for immediate delivery worldwide – for virtually any vehicle application.
- USCAR / ISO Standard Compliant**
 Terminal blade sizes meet USCAR and ISO standards (0.64 x 0.64, 1.5 x 0.8, 2.8 x 0.8, 6.3 x 0.8).
- Terminal Position Assurance Device**
 Yazaki's Terminal Position Assurance Device is available front-loaded and preset to the connector housing.
- Wire Gauges for Every Application**
 The YESC KAIZEN connector series is compatible with a wide range of both US (AWG) and metric (mm²) wire sizes.
- Interchangeable With YESC**
 All YESC KAIZEN connectors (except for the 0.64 series) have the same footprint as, and are fully interchangeable with, equivalent standard YESC.
- Designed to Perform**
 All YESC KAIZEN connectors are designed to meet USCAR performance specifications.

SEALED

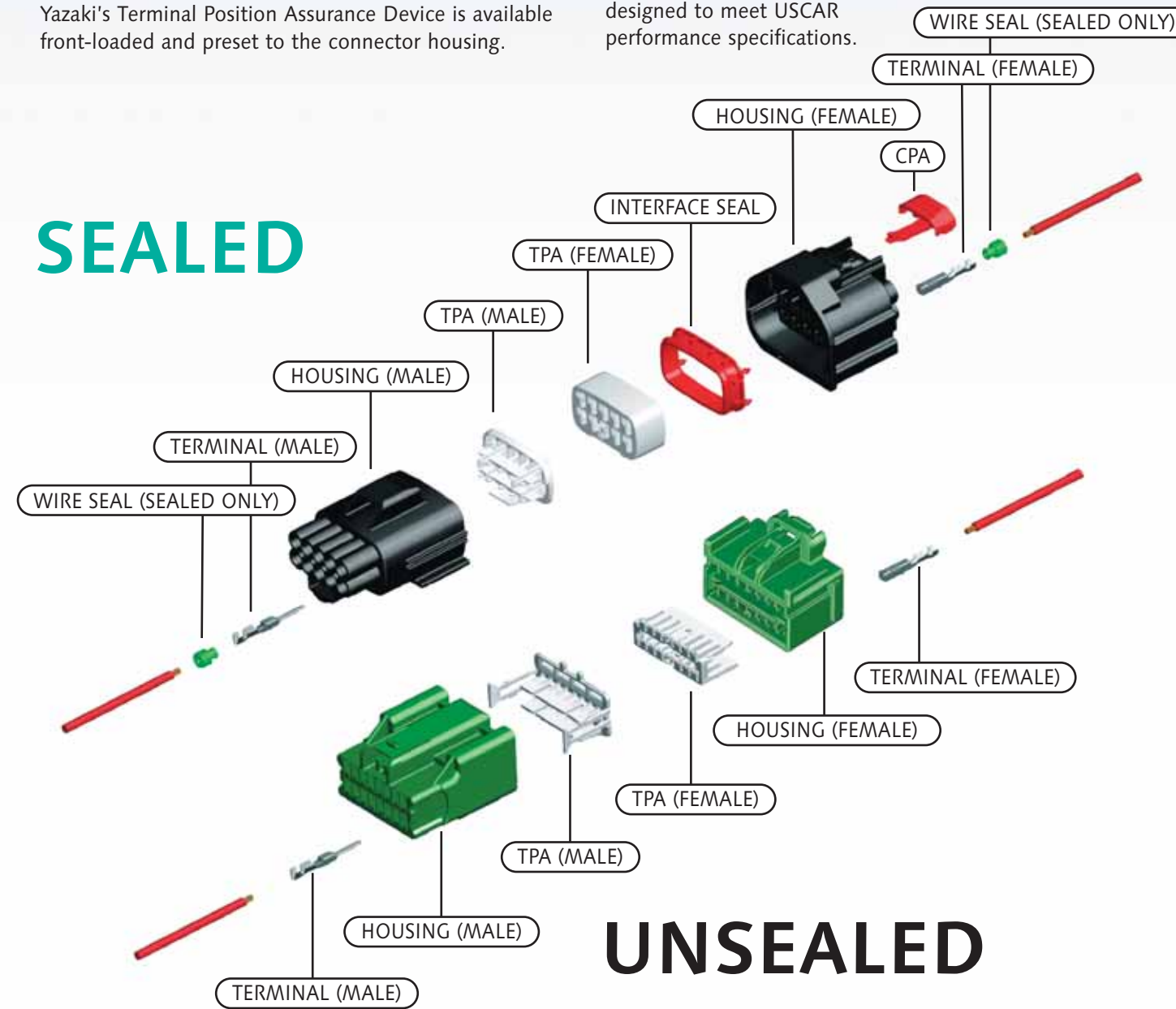

UNSEALED

BACK TO YESC KAIZEN
CONTENTS MENU

YESC KAIZEN

CONNECTORS

0.64

SERIES

UNSEALED

0.64 SERIES
UNSEALED

CLICK ON YOUR SELECTION:



- CONSTRUCTION
- SPECIFICATIONS
- CURRENT RATING CURVE
- TERMINAL
- RETAINER CLIP/BRACKET DIMENSIONS
- PART NUMBER SUMMARY CHART
- PHOTOS/DIMENSIONS
- NAVIGATION TIPS

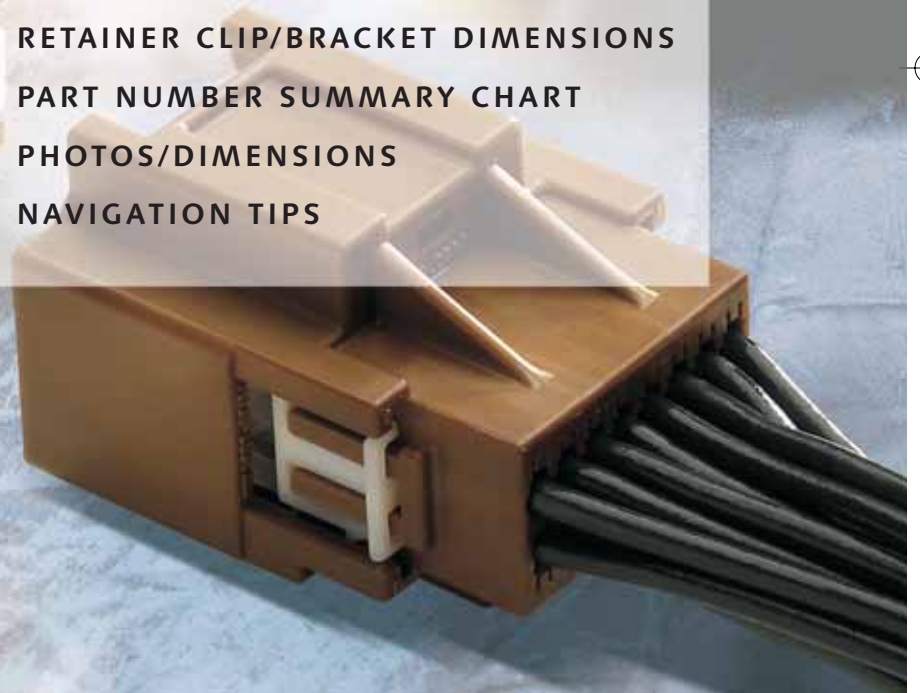

SUPPLEMENT TO YESC CATALOG

0.64 x 0.64

unsealed connection system

Construction

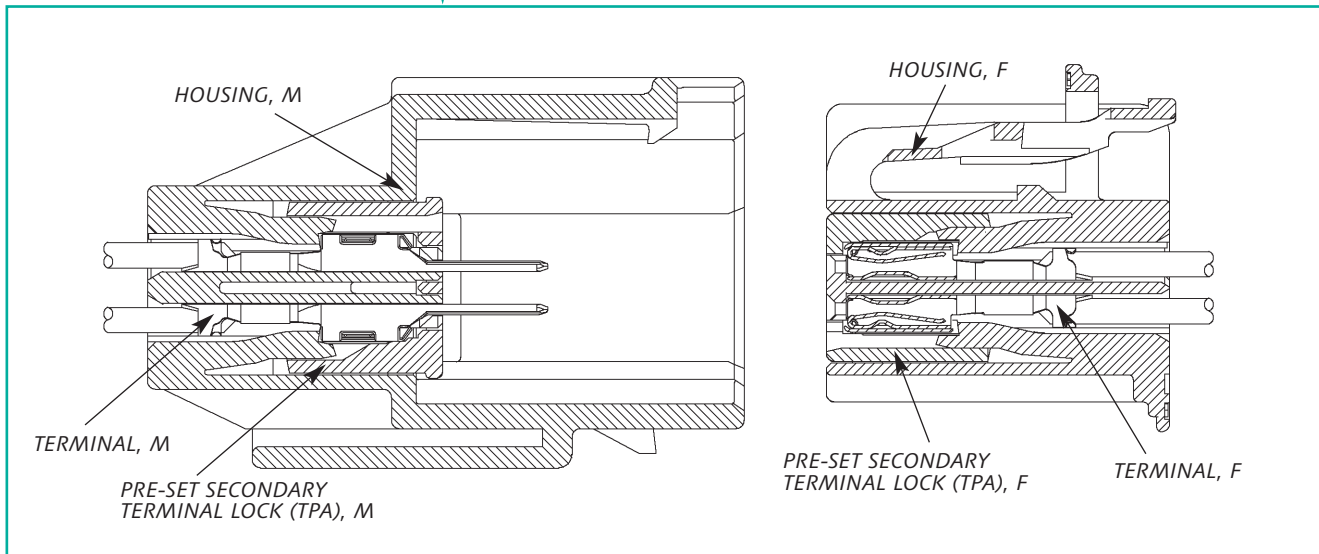

Specifications

Material	Connector	PBT+GF
	Male Terminal	Copper Alloy (Sn/Au Plate)
	Female Terminal	Copper Alloy (Sn/Au Plate)
Operating Temperature Range		-40°C ~ 100°C (120°C max temp.) (USCAR Class II)
Current Capacity		(See Chart)
Voltage Drop		20mΩ max (Term./Term.) (Crimp-to-Crimp)
Isolation Resistance		500VDC, 20MΩ min
Dielectric Resistance		1000VAC (1 minute)
Applicable Wire Size		22AWG ~ 18AWG (0.30mm ² ~ 0.85mm ²) 1.90mm max Wire O.D.
Terminal Pitch		Horizontal: 2.54mm; Vertical: 2.54mm
Terminal-to-Connector Retention Force		75N min
Connector-to-Connector Retention Force		110N min

Current Rating Curve (Reference Only)

This data is based on single circuit/connector evaluation. Data should be used as reference only. Appropriate derating should be considered based upon specific application requirements.

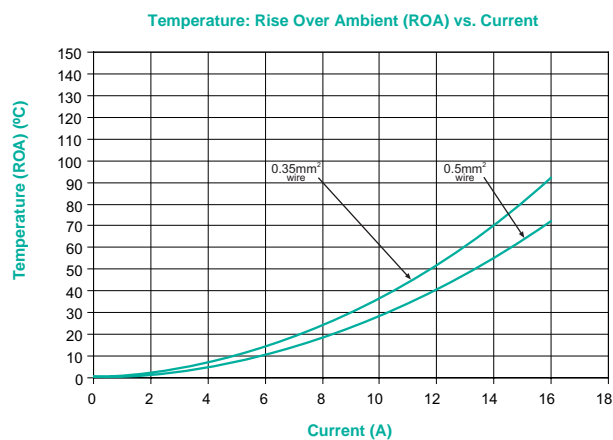

unsealed connection system

0.64 x 0.64

Terminal

UNIT: mm

Male Terminal

Material: Copper Alloy Thickness: $t=0.2$

This terminal system mates to either a 0.64mm or 0.8mm wide terminal blade.

Female Terminal

Material: Copper Alloy Thickness: $t=0.2$

Description	Part Number	Plating	Applicable Wire Size		
			Europe (mm ²)	U.S.A. (AWG)	Japan (mm ²)
Male Terminal	7114-4618-02	Sn	0.35 ~ 0.5	22 ~ 20	0.3 ~ 0.5
	7114-4619-02	Sn	0.75	18	0.85
	7114-4618-08	Au	0.35 ~ 0.5	22 ~ 20	0.3 ~ 0.5
	7114-4619-08	Au	0.75	18	0.85
Female Terminal	7116-4618-02	Sn	0.35 ~ 0.5	22 ~ 20	0.3 ~ 0.5
	7116-4619-02	Sn	0.75	18	0.85
	7116-4618-08	Au	0.35 ~ 0.5	22 ~ 20	0.3 ~ 0.5
	7116-4619-08	Au	0.75	18	0.85

Retainer Clip/Bracket Dimensions

UNIT: mm

Part Number	Panel Hole Requirements
7047-9580 (Ref)	φ6.5mm

0.64 x 0.64

unsealed connection system

Part Number Summary Chart

Part Name	Male	Female
Terminal	7114-4618-02	7116-4618-02
	7114-4619-02	7116-4619-02
	7114-4618-08	7116-4618-08
	7114-4619-08	7116-4619-08
Applicable Clip	7047-9580 (Ref)	—

Pole	Polarity	Color/Description	Male Part Number	Female Part Number	Delete Caps
4	A	Black	—	7283-9016-30	—
8	A	Black	7282-9022-30	7283-9028-30	—
8	B	Light Grey	—	7283-9029-40	—
10	A	Black	—	7283-9040-30	—
10	D	Green	—	7283-9043-60	—
10	F	Natural	—	7283-9045	—
10	A	Black	7282-9082-30	7283-9088-30	—
14	B	Light Grey	—	7283-9065-40	—
14	E	Blue	—	7283-9068-90	—
16	A	Black	—	7283-9076-30	—
16	C	Brown	7282-9072-80	7283-9078-80	—
16	D	Green	—	7283-9079-60	—
16	E	Blue	—	7283-9080-90	—
16	F	Natural	—	7283-9081	—
16	A	Black	—	7283-9282-30	—
16	B	Light Grey	—	7283-9283-40	—
16	C	Brown	—	7283-9284-80	—
18	A	Black	—	7283-4544-30	—
18	D	Green	—	7283-4548-60	—
18	A	Black	—	7283-9110-30	—
20	B	Light Grey	—	7283-9111-40	—
20	C	Brown	—	7283-9112-80	—

Applicable Terminal Removal Tool/Dimensions

Refer to Page 120 for YESC KAIZEN Connector Terminal Removal Tool.
Order Number: 49YA000263.

unsealed connection system

0.64 x 0.64

Housing Material: PBT+GF

UNIT: mm

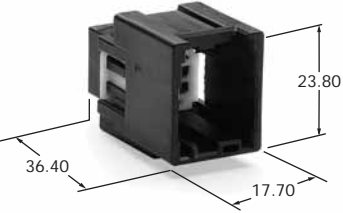
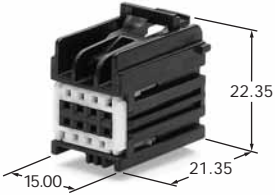
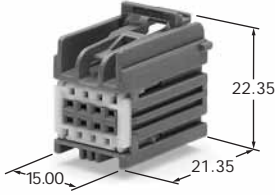
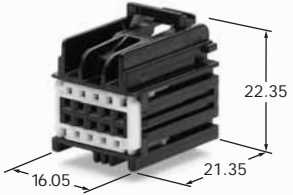
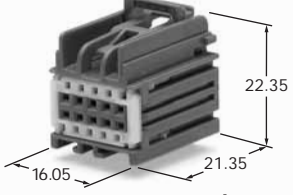
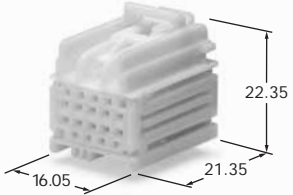
Poles	Male Housing	Female Housing
4	N/A	 <p>7283-9016-30*</p>
8	 <p>7282-9022-30</p>	 <p>7283-9028-30*</p>
8	N/A	 <p>7283-9029-40*</p>
10	N/A	 <p>7283-9040-30*</p>
10	N/A	 <p>7283-9043-60*</p>
10	N/A	 <p>7283-9045*</p>

GO TO PAGE 2 OF 4

*Part meets USCAR interface standard at time of printing.

0.64 x 0.64

unsealed connection system

Housing Material: PBT+GF

UNIT: mm

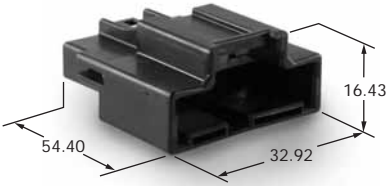
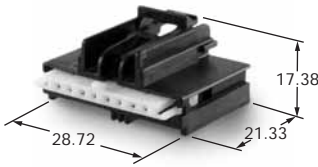
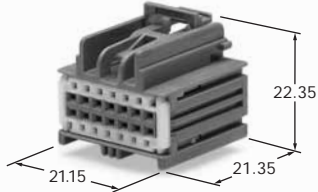
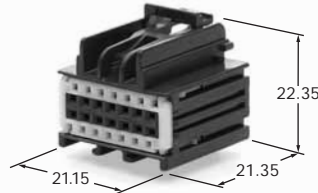
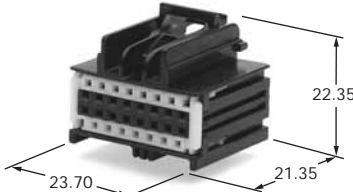
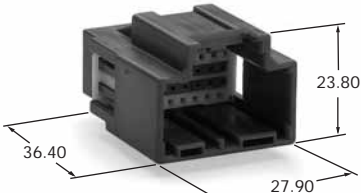
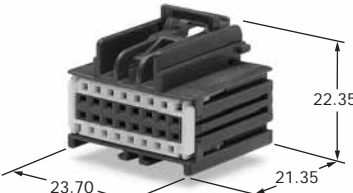
Poles	Male Housing	Female Housing
10	 <p>7282-9082-30</p>	 <p>7283-9088-30</p>
14	N/A	 <p>7283-9065-40*</p>
14	N/A	 <p>7283-9068-90*</p>
16	N/A	 <p>7283-9076-30*</p>
16	 <p>7282-9072-80</p>	 <p>7283-9078-80*</p>

* Part meets USCAR interface standard at time of printing.

unsealed connection system

0.64 x 0.64

Housing Material: PBT+GF

UNIT: mm

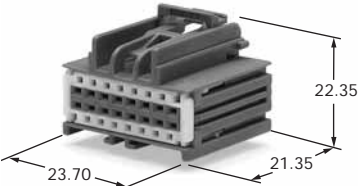
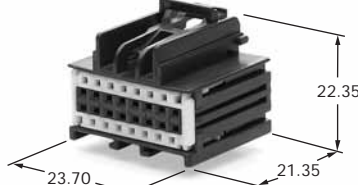
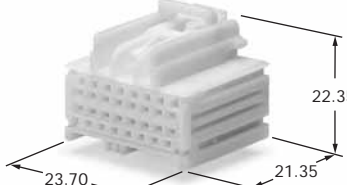
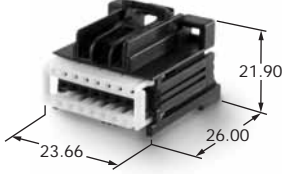
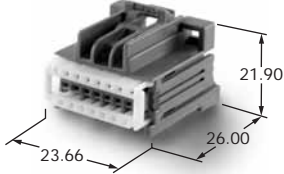
Poles	Male Housing	Female Housing
16	N/A	 <p>7283-9079-60*</p>
16	N/A	 <p>7283-9080-90*</p>
16	N/A	 <p>7283-9081*</p>
16	N/A	 <p>7283-9282-30</p>
16	N/A	 <p>7283-9283-40</p>

* Part meets USCAR interface standard at time of printing.

0.64 x 0.64

unsealed connection system

Housing Material: PBT+GF

UNIT: mm

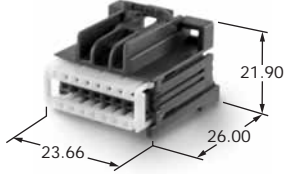
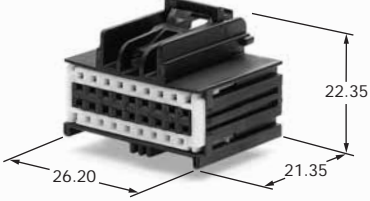
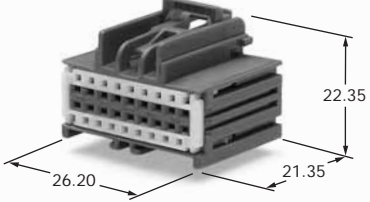
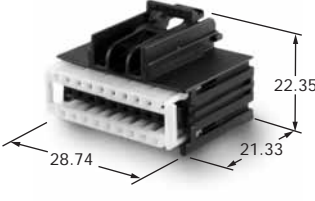
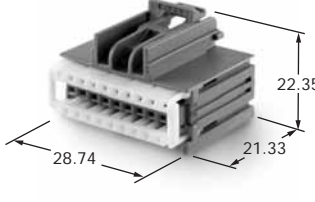
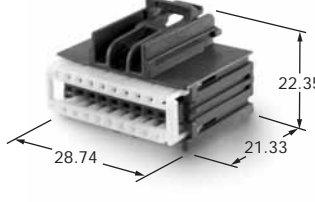
Poles	Male Housing	Female Housing
16	N/A	 <p data-bbox="1190 661 1357 691">7283-9284-80</p>
18	N/A	 <p data-bbox="1190 932 1357 962">7283-4544-30*</p>
18	N/A	 <p data-bbox="1190 1207 1357 1237">7283-4548-60*</p>
18	N/A	 <p data-bbox="1190 1483 1357 1513">7283-9110-30</p>
20	N/A	 <p data-bbox="1190 1758 1357 1788">7283-9111-40</p>
20	N/A	 <p data-bbox="1190 2025 1357 2054">7283-9112-80</p>

BACK TO YESC KAIZEN
CONTENTS MENU

YESC KAIZEN

CONNECTORS

0.64

SERIES

SEALED

0.64 SERIES
SEALED

CLICK ON YOUR SELECTION:

- CONSTRUCTION
- SPECIFICATIONS
- CURRENT RATING CURVE
- TERMINAL
- RETAINER CLIP/BRACKET DIMENSIONS
- PART NUMBER SUMMARY CHART
- PHOTOS/DIMENSIONS
- NAVIGATION TIPS

SUPPLEMENT TO YESC CATALOG

0.64 x 0.64

sealed connection system

Construction

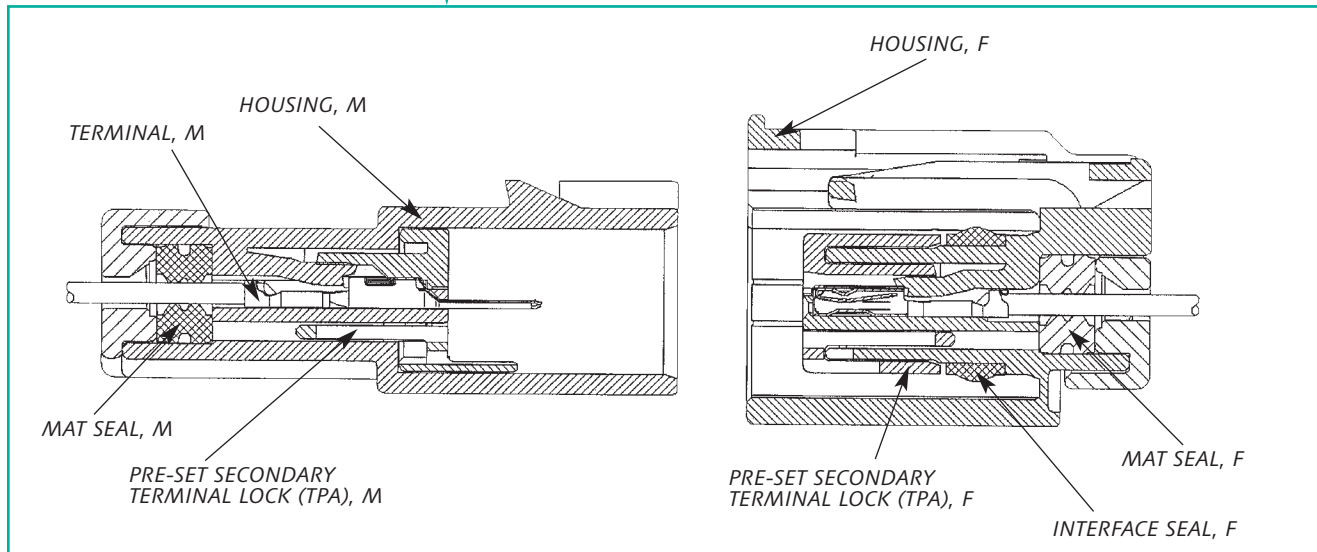

Specifications

Material	Connector	PBT+GF
	Male Terminal	Copper Alloy (Sn/Au Plate)
	Female Terminal	Copper Alloy (Sn/Au Plate)
Operating Temperature Range		-40°C ~ 125°C (145°C max temp.) (USCAR Class III)
Current Capacity		(See Chart)
Voltage Drop		20mΩ max (Term./Term.) (Crimp-to-Crimp)
Isolation Resistance		500VDC, 20MΩ min
Dielectric Resistance		1000VAC (1 minute)
Applicable Wire Size		22AWG ~ 18AWG (0.30mm ² ~ 0.85mm ²) 1.90mm max Wire O.D.
Terminal Pitch		Horizontal: 2.54mm; Vertical: 2.54mm
Sealing Performance (Air-Leak Pressure)		48KPa min (Pre-Heat Soak); 28KPa (Post-Heat Soak)
Terminal-to-Connector Retention Force		75N min
Connector-to-Connector Retention Force		110N min

Current Rating Curve (Reference Only)

This data is based on single circuit/connector evaluation. Data should be used as reference only. Appropriate derating should be considered based upon specific application requirements.

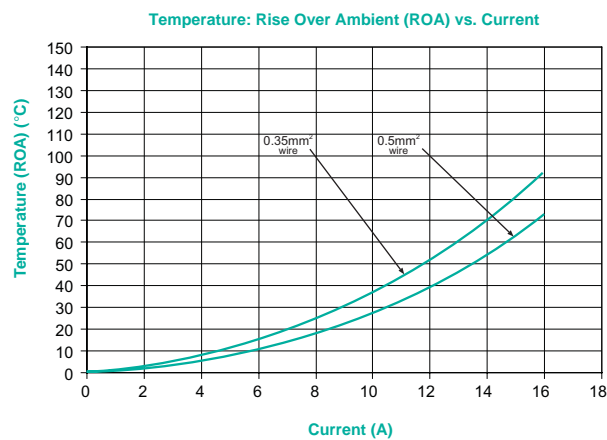

sealed connection system

0.64 x 0.64

Terminal

UNIT: mm

Male Terminal

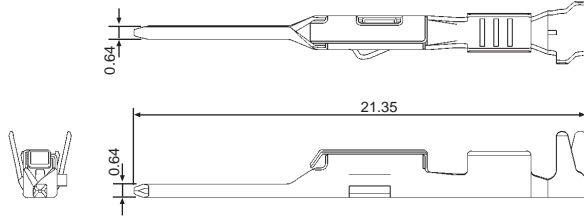

Material: Copper Alloy

Thickness: t=0.2

This terminal system mates to either a 0.64mm or 0.8mm wide terminal blade.

Female Terminal

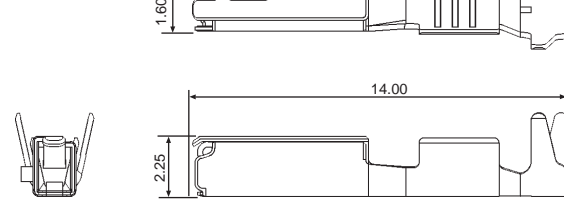

Material: Copper Alloy

Thickness: t=0.2

Description	Part Number	Plating	Applicable Wire Size		
			Europe (mm ²)	U.S.A. (AWG)	Japan (mm ²)
Male Terminal	7114-4618-02	Sn	0.35 ~ 0.5	22 ~ 20	0.3 ~ 0.5
	7114-4619-02	Sn	0.75	18	0.85
	7114-4618-08	Au	0.35 ~ 0.5	22 ~ 20	0.3 ~ 0.5
	7114-4619-08	Au	0.75	18	0.85
Female Terminal	7116-4618-02	Sn	0.35 ~ 0.5	22 ~ 20	0.3 ~ 0.5
	7116-4619-02	Sn	0.75	18	0.85
	7116-4618-08	Au	0.35 ~ 0.5	22 ~ 20	0.3 ~ 0.5
	7116-4619-08	Au	0.75	18	0.85

Retainer Clip/Bracket Dimensions

UNIT: mm

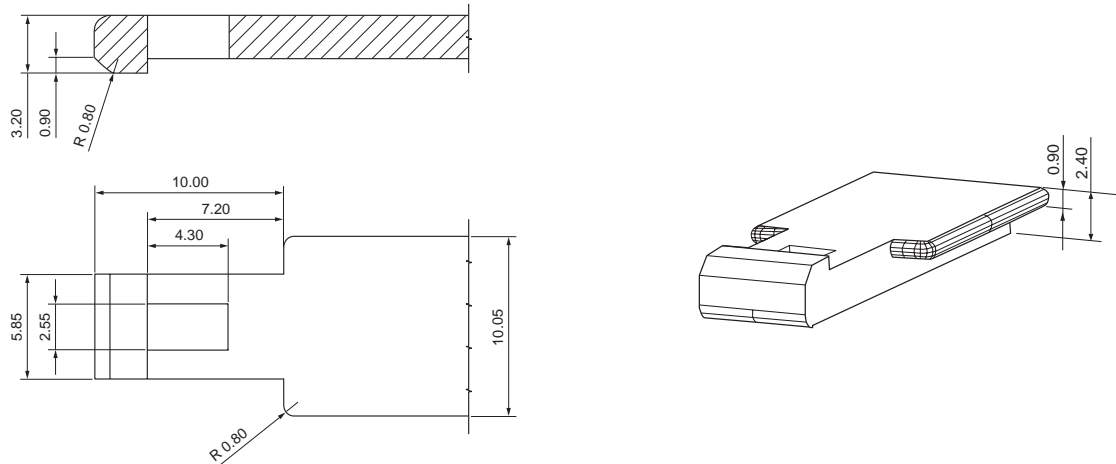

Part Number	Panel Hole Requirements
7047-9580 (Ref)	φ6.5mm

0.64 x 0.64

sealed connection system

Part Number Summary Chart

Part Name	Male	Female
<i>Terminal</i>	7114-4618-02	7116-4618-02
	7114-4619-02	7116-4619-02
	7114-4618-08	7116-4618-08
	7114-4619-08	7116-4619-08
<i>Applicable Clip</i>	7047-9580 (Ref)	—

Pole	Polarity	Color/Description	Male Part Number	Female Part Number	Delete Caps
5	A	Black	7282-2004-30	7283-2004-30	—
5	A	Black	7282-2005-30	7283-2005-30	—
5	A	Black	7282-2006-30	7283-2006-30	—

Housing Material: PBT+GF

UNIT: mm

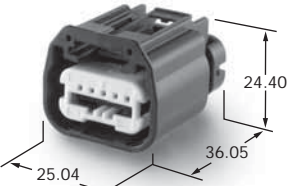
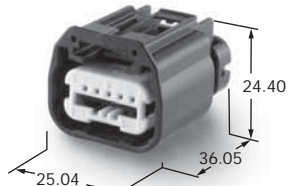
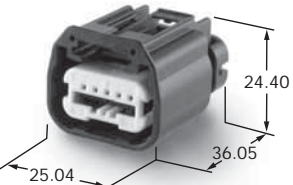
Poles	Male Housing	Female Housing
5	<p>PHOTO UNAVAILABLE</p> <p>7282-2004-30</p>	 <p>7283-2004-30</p>
5	<p>PHOTO UNAVAILABLE</p> <p>7282-2005-30</p>	 <p>7283-2005-30</p>
5	<p>PHOTO UNAVAILABLE</p> <p>7282-2006-30</p>	 <p>7283-2006-30</p>

Applicable Terminal Removal Tool/Dimensions

Refer to Page 120 for YESC KAIZEN Connector Terminal Removal Tool.

Order Number: 49YA000263.

BACK TO YESC KAIZEN
CONTENTS MENU

YESC KAIZEN

CONNECTORS

1.5

SERIES

UNSEALED

1.5 SERIES
UNSEALED

CLICK ON YOUR SELECTION:

- CONSTRUCTION
- SPECIFICATIONS
- CURRENT RATING CURVE
- TERMINAL
- RETAINER CLIP/BRACKET DIMENSIONS
- PART NUMBER SUMMARY CHART
- PHOTOS/DIMENSIONS
- NAVIGATION TIPS

SUPPLEMENT TO YESC CATALOG

1.5 x 0.8

unsealed connection system

Construction

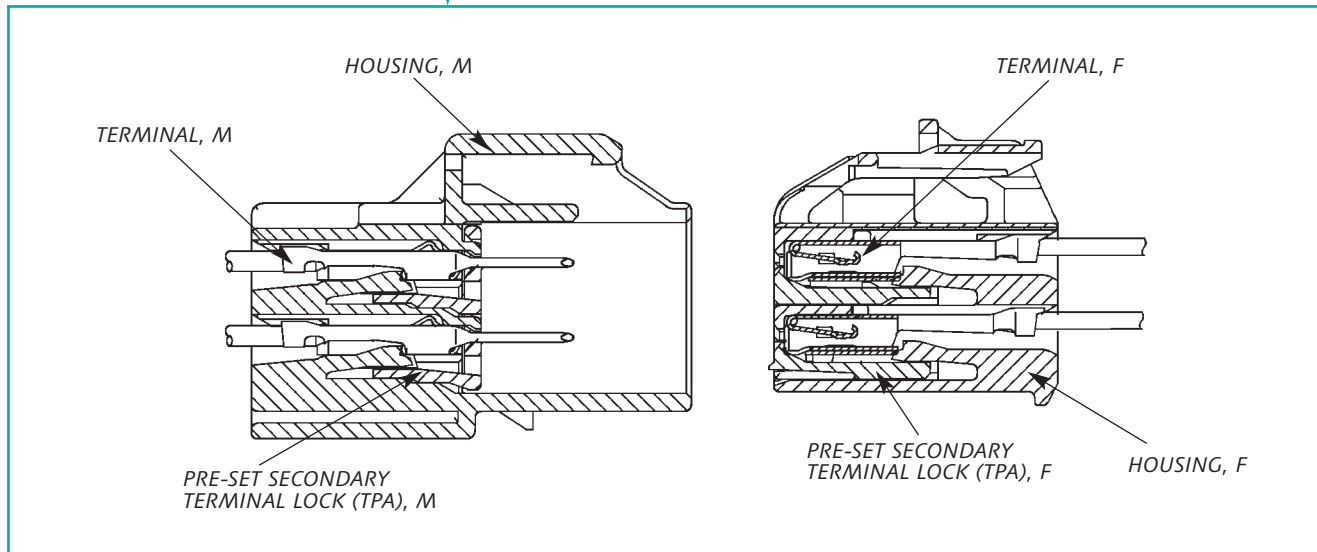

Specifications

Material	Connector	PBT+GF
	Male Terminal	Copper Alloy (Sn/Au Plate)
	Female Terminal	Copper Alloy (Sn/Au Plate)
Operating Temperature Range		-40°C ~125°C (145°C max temp.) (USCAR Class III)
Current Capacity		(See Chart)
Voltage Drop		10mΩ max (Term./Term.) (Crimp-to-Crimp)
Isolation Resistance		500VDC, 20MΩ min
Dielectric Resistance		1000VAC (1 minute)
Applicable Wire Size		22AWG ~ 16AWG (0.35mm ² ~ 1.0mm ²)
Terminal Pitch		Horizontal: 3.50mm; Vertical: 6.50mm
Terminal-to-Connector Retention Force		90N min
Connector-to-Connector Retention Force		110N min

Current Rating Curve (Reference Only)

This data is based on single circuit/connector evaluation. Data should be used as reference only. Appropriate derating should be considered based upon specific application requirements.

0.35mm² rating curve not shown.
Current capability of terminal exceeds capacity of wire.

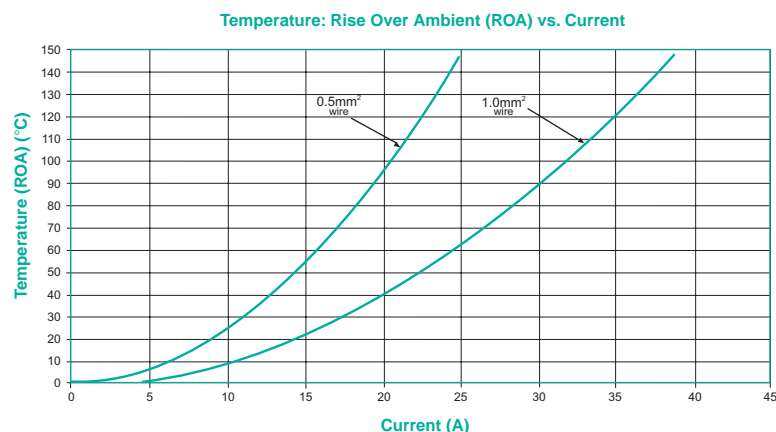

unsealed connection system

1.5 x 0.8

Terminal

UNIT: mm

Male Terminal

Material: Copper Alloy Thickness: $t=0.3$

Female Terminal

Material: Copper Alloy Thickness: $t=0.25$

Description	YESC Part Number	YESC KAIZEN Part Number	Plating	Applicable Wire Size		
				Europe (mm ²)	U.S.A. (AWG)	Japan (mm ²)
Male Terminal	7114-4100-02	—	Sn	0.35 ~ 0.5	22 ~ 20	0.3 ~ 0.5
	7114-4101-02	—	Sn	0.75 ~ 1.0	18 ~ 16	0.85 ~ 1.25
	7114-4100-08	—	Au	0.35 ~ 0.5	22 ~ 20	0.3 ~ 0.5
	7114-4101-08	—	Au	0.75 ~ 1.0	18 ~ 16	0.85 ~ 1.25
Female Terminal	7116-4100-02	7116-4780-02	Sn	0.35 ~ 0.5	22 ~ 20	0.3 ~ 0.5
	7116-4101-02	7116-4781-02	Sn	0.75 ~ 1.0	18 ~ 16	0.85 ~ 1.25
	7116-4100-08	—	Au	0.35 ~ 0.5	22 ~ 20	0.3 ~ 0.5
	7116-4101-08	—	Au	0.75 ~ 1.0	18 ~ 16	0.85 ~ 1.25

YESC KAIZEN is preferred (equal performance/lower insertion force)

Retainer Clip/Bracket Dimensions

UNIT: mm

Part Number	Panel Hole Requirements
7047-9580 (Ref)	φ6.5mm

1.5 x 0.8

unsealed connection system

Part Number Summary Chart

Part Name	YESC Male	YESC KAIZEN Male	YESC Female	YESC KAIZEN Female
Terminal	7114-4100-02	—	7116-4100-02	7116-4780-02
	7114-4101-02	—	7116-4101-02	7116-4781-02
	7114-4100-08	—	7116-4100-08	—
	7114-4101-08	—	7116-4101-08	—
Applicable Clip	—	7047-9580 (Ref)	—	—

Pole	Polarity	Color/Description	YESC Male Part Number	YESC KAIZEN Male Part Number	YESC Female Part Number	YESC KAIZEN Female Part Number	Delete Caps
2	A	Light Grey	—	7282-6443-40	—	7283-6443-40	—
2	A	Orange	—	7282-6443-50	—	7283-6443-50	—
2	B	Green	—	7282-6444-60	—	7283-6444-60	—
2	B	Yellow	—	7282-6444-70	—	7283-6444-70	—
3	A	Light Grey	—	7282-3440-40	—	7283-3440-40	—
4	A	Light Grey	—	7282-6449-40	—	7283-6449-40	—
4	A	Orange	—	—	—	7283-6449-50	—
4	A	Yellow	—	—	—	7283-6449-70	—
4	B	Green	—	7282-3443-60	—	7283-3443-60	—
6	A	Light Grey	—	7282-6454-40	—	7283-6454-40	—
6	B	Green	—	—	—	7283-4016-60	—
8	A	Light Grey	—	7282-3441-40	—	7283-3441-40	—
10	A	Light Grey	—	7282-6455-40	—	7283-6455-40	—
12	A	Light Grey	—	7282-3442-40	—	7283-3442-40	—
16	A	Green	—	7282-6453-60	—	7283-6453-60	7282-5690-60
16	B	Blue	—	7282-6456-90	—	7283-6456-90	—
16	C	Light Grey	7282-5536-40	—	—	7283-3585-40	—

Applicable Terminal Removal Tool/Dimensions

Refer to Page 120 for YESC KAIZEN Connector Terminal Removal Tool.







Order Number: X39899-J374.

unsealed connection system

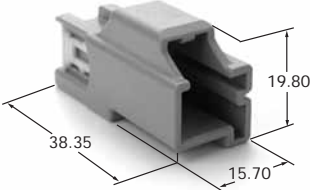
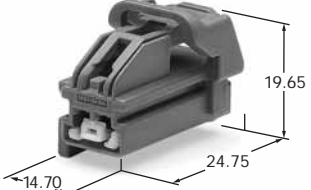
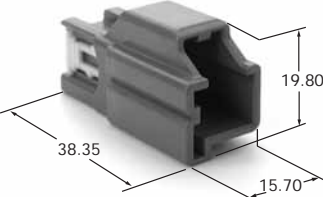
1.5 x 0.8

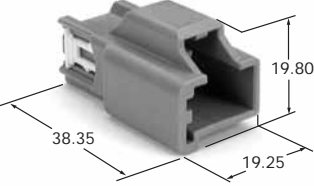
Housing Material: PBT+GF

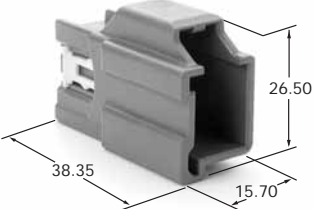
UNIT: mm

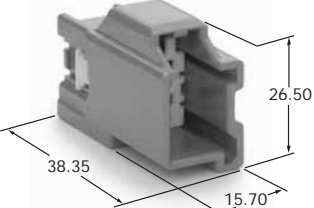
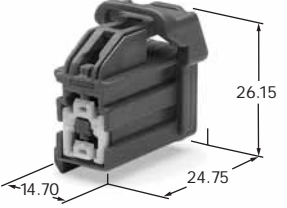
Poles	Male Housing	Female Housing
2	 <p>7282-6443-40</p>	 <p>7283-6443-40*</p>
2	 <p>7282-6444-60</p>	 <p>7283-6444-60*</p>
3	 <p>7282-3440-40</p>	 <p>7283-3440-40*</p>
4	 <p>7282-6449-40</p>	 <p>7283-6449-40*</p>
4	 <p>7282-3443-60</p>	 <p>7283-3443-60*</p>



* Part meets USCAR interface standard at time of printing.

1.5 x 0.8

unsealed connection system

Housing Material: PBT+GF

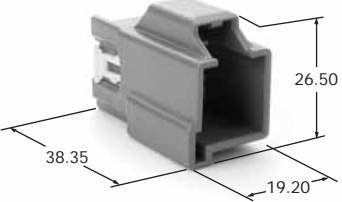
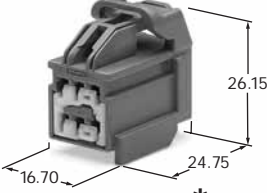
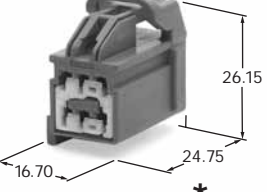
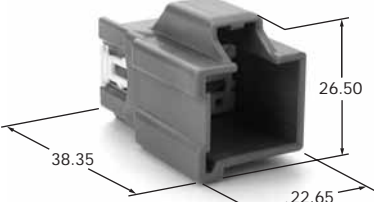
UNIT: mm

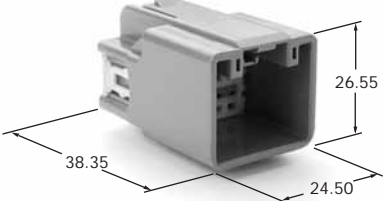
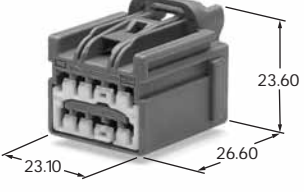
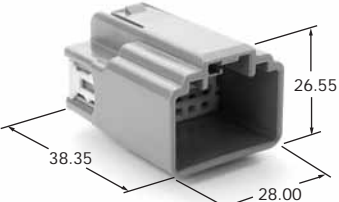
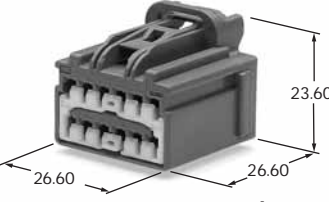
Poles	Male Housing	Female Housing
6	 <p>7282-6454-40</p>	 <p>7283-6454-40*</p>
6	N/A	 <p>7283-4016-60*</p>
8	 <p>7282-3441-40</p>	 <p>7283-3441-40*</p>
10	 <p>7282-6455-40</p>	 <p>7283-6455-40*</p>
12	 <p>7282-3442-40</p>	 <p>7283-3442-40*</p>

* Part meets USCAR interface standard at time of printing.

unsealed connection system

1.5 x 0.8

Housing Material: PBT+GF

UNIT: mm

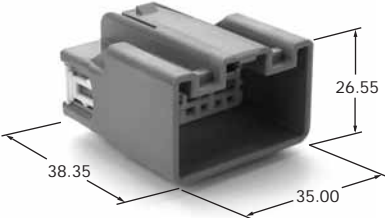
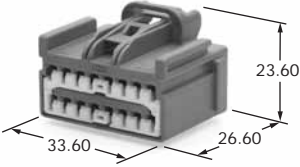
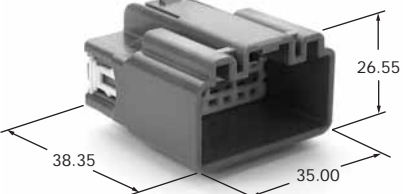
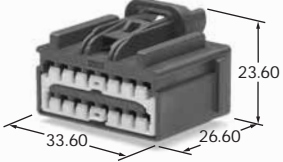
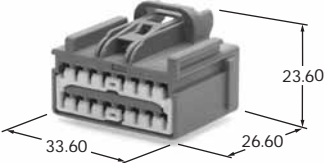
Poles	Male Housing	Female Housing
16	 <p>7282-6453-60</p>	 <p>7283-6453-60*</p>
16	 <p>7282-6456-90</p>	 <p>7283-6456-90*</p>
16	N/A	 <p>7283-3585-40*</p>

* Part meets USCAR interface standard at time of printing.

YESC KAIZEN

CONNECTORS

2.8

SERIES

UNSEALED

CLICK ON YOUR SELECTION:



- CONSTRUCTION
- SPECIFICATIONS
- CURRENT RATING CURVE
- TERMINAL
- RETAINER CLIP/BRACKET DIMENSIONS
- PART NUMBER SUMMARY CHART
- PHOTOS/DIMENSIONS
- NAVIGATION TIPS

2.8 SERIES
UNSEALED

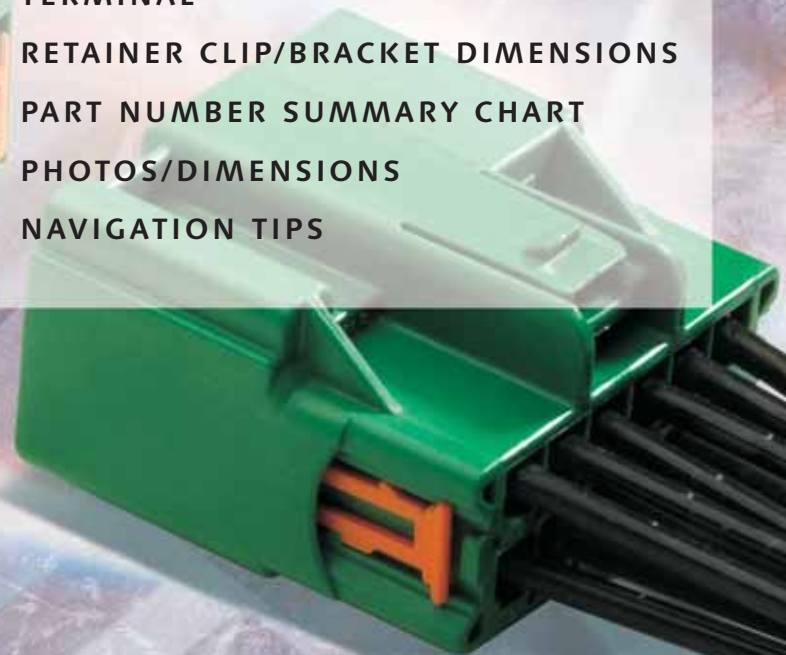

SUPPLEMENT TO YESC CATALOG

2.8 x 0.8

unsealed connection system

Construction

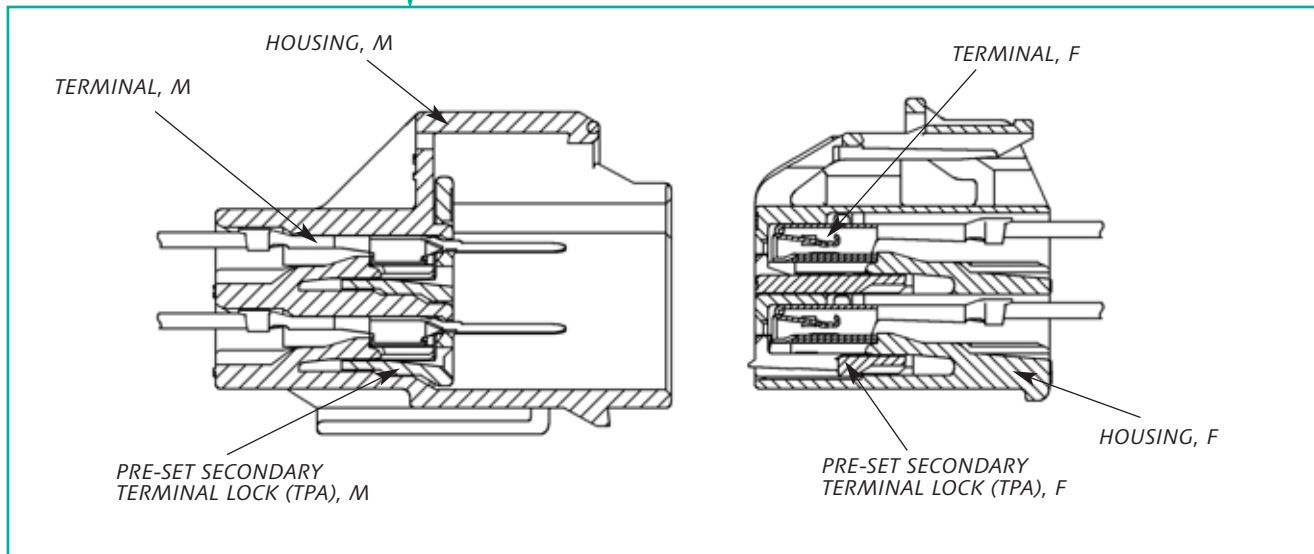

Specifications

Material	Connector	PBT + GF
	Male Terminal	Copper Alloy (Sn Plate)
	Female Terminal	Copper Alloy (Sn Plate)
Operating Temperature Range		-40°C ~ 125°C (145°C max temp.) (USCAR Class III)
Current Capacity		(See Chart)
Voltage Drop		10mΩ max (Term./Term.) (Crimp-to-Crimp)
Isolation Resistance		500VDC, 20MΩ min
Dielectric Resistance		1000VAC (1 minute)
Applicable Wire Size		22AWG ~ 14AWG (0.35mm ² ~ 2.5mm ²)
Terminal Pitch		Horizontal: 5.00mm; Vertical: 6.80mm
Terminal-to-Connector Retention Force		90N min
Connector-to-Connector Retention Force		110N min

Current Rating Curve (Reference Only)

This data is based on single circuit/connector evaluation. Data should be used as reference only. Appropriate derating should be considered based upon specific application requirements.

0.35mm² rating curve not shown.
Current capability of terminal exceeds capacity of wire.

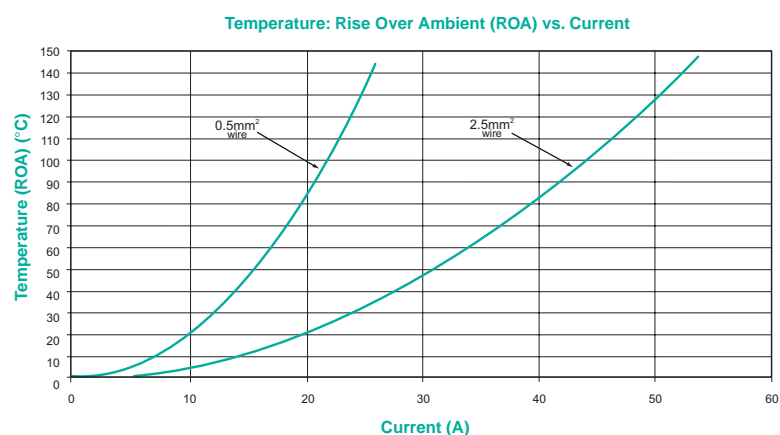

2.8 x 0.8

unsealed connection system

Terminal

UNIT: mm

Male Terminal

Material: Copper Alloy Thickness: t=0.3

Female Terminal

Material: Copper Alloy Thickness: t=0.3

Description	YESC Part Number	YESC KAIZEN Part Number	Plating	Applicable Wire Size		
				Europe (mm ²)	U.S.A. (AWG)	Japan (mm ²)
Male Terminal	7114-4110-02	—	Sn	0.35 ~ 0.5	22 ~ 20	0.3 ~ 0.5
	7114-4111-02	—	Sn	0.75 ~ 1.0	18 ~ 16	0.85 ~ 1.25
	7114-4112-02	—	Sn	1.5 ~ 2.5	14	2.0
Female Terminal	7116-4110-02	7116-4270-02	Sn	0.35 ~ 0.5	22 ~ 20	0.3 ~ 0.5
	7116-4111-02	7116-4271-02	Sn	0.75 ~ 1.0	18 ~ 16	0.85 ~ 1.25
	7116-4112-02	7116-4272-02	Sn	1.5 ~ 2.5	14	2.0

YESC KAIZEN is preferred (equal performance/lower insertion force)

Retainer Clip/Bracket Dimensions

UNIT: mm

Part Number	Panel Hole Requirements
7047-9580 (Ref)	φ6.5mm

2.8 x 0.8

unsealed connection system

Part Number Summary Chart

Part Name	YESC Male	YESC KAIZEN Male	YESC Female	YESC KAIZEN Female
Terminal	7114-4110-02	---	7116-4110-02	7116-4270-02
	7114-4111-02	---	7116-4111-02	7116-4271-02
	7114-4112-02	---	7116-4112-02	7116-4272-02
Applicable Clip	---	7047-9580 (Ref)	---	---

Pole	Polarity	Color/Description	YESC Male Part Number	YESC KAIZEN Male Part Number	YESC Female Part Number	YESC KAIZEN Female Part Number	Delete Caps
2	A	Light Grey	---	7282-6445-40	---	7283-6445-40	---
4	A	Light Grey	---	7282-6446-40	---	7283-6446-40	---
6	A	Light Grey	---	7282-6466-40	---	7283-6466-40	---
6	B	Green/ Direct only	---	---	---	7283-3242-60	---
8	A	Light Grey	---	7282-3243-40	---	7283-3243-40	---
8	B	Green/ Direct only	---	---	---	7283-3244-60	---
10	A	Light Grey	---	7282-6457-40	---	7283-6457-40	---
12	A	Light Grey	---	7282-6467-40	---	7283-6467-40	---
12	B	Green	---	7282-6468-60	---	7283-6468-60	---

Applicable Terminal Removal Tool/Dimensions







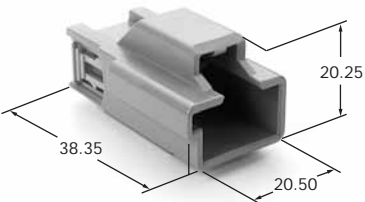
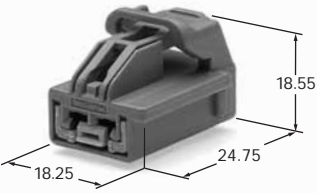

Refer to Page 120 for YESC KAIZEN Connector Terminal Removal Tool.
Order Number: X39899-J374.

unsealed connection system

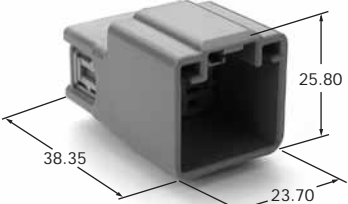
2.8 x 0.8

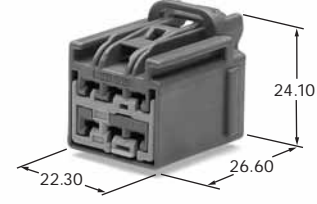
Housing Material: PBT+GF

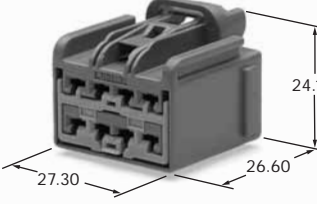
UNIT: mm

Poles	Male Housing	Female Housing
2	 <p>7282-6445-40</p>	 <p>7283-6445-40</p>
4	 <p>7282-6446-40</p>	 <p>7283-6446-40</p>
6	 <p>7282-6466-40</p>	 <p>7283-6466-40</p>
6	N/A	 <p>7283-3242-60</p>
8	 <p>7282-3243-40</p>	 <p>7283-3243-40</p>
8	N/A	 <p>7283-3244-60</p>

2.8 x 0.8

unsealed connection system

Housing Material: **PBT+GF**

UNIT: mm

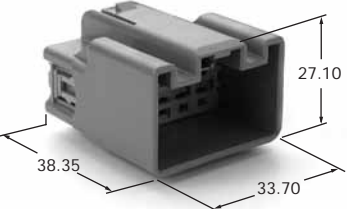
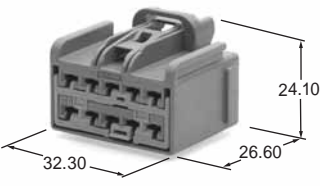
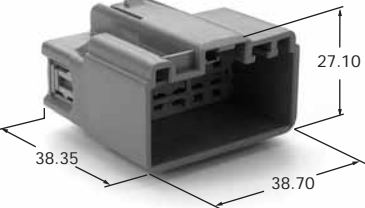
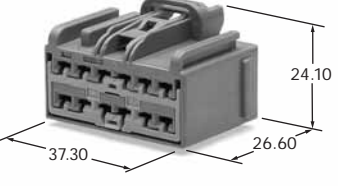
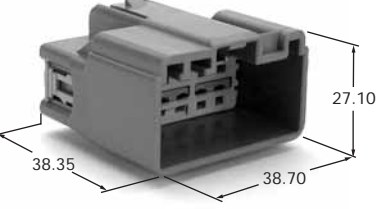
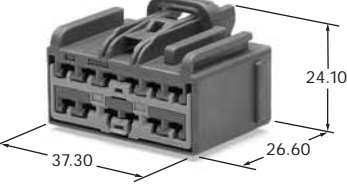
Poles	Male Housing	Female Housing
10	 <p>7282-6457-40</p>	 <p>7283-6457-40</p>
12	 <p>7282-6467-40</p>	 <p>7283-6467-40</p>
12	 <p>7282-6468-60</p>	 <p>7283-6468-60</p>

[BACK TO YESC CONTENTS MENU](#)

YESC KAIZEN

CONNECTORS

6.3

SERIES

UNSEALED

CLICK ON YOUR SELECTION:

- [CONSTRUCTION](#)
- [SPECIFICATIONS](#)
- [CURRENT RATING CURVE](#)
- [TERMINAL](#)
- [RETAINER CLIP/BRACKET DIMENSIONS](#)
- [PART NUMBER SUMMARY CHART](#)
- [PHOTOS/DIMENSIONS](#)
- [NAVIGATION TIPS](#)

**6.3 SERIES
UNSEALED**

SUPPLEMENT TO YESC CATALOG

6.3 x 0.8

unsealed connection system

Construction

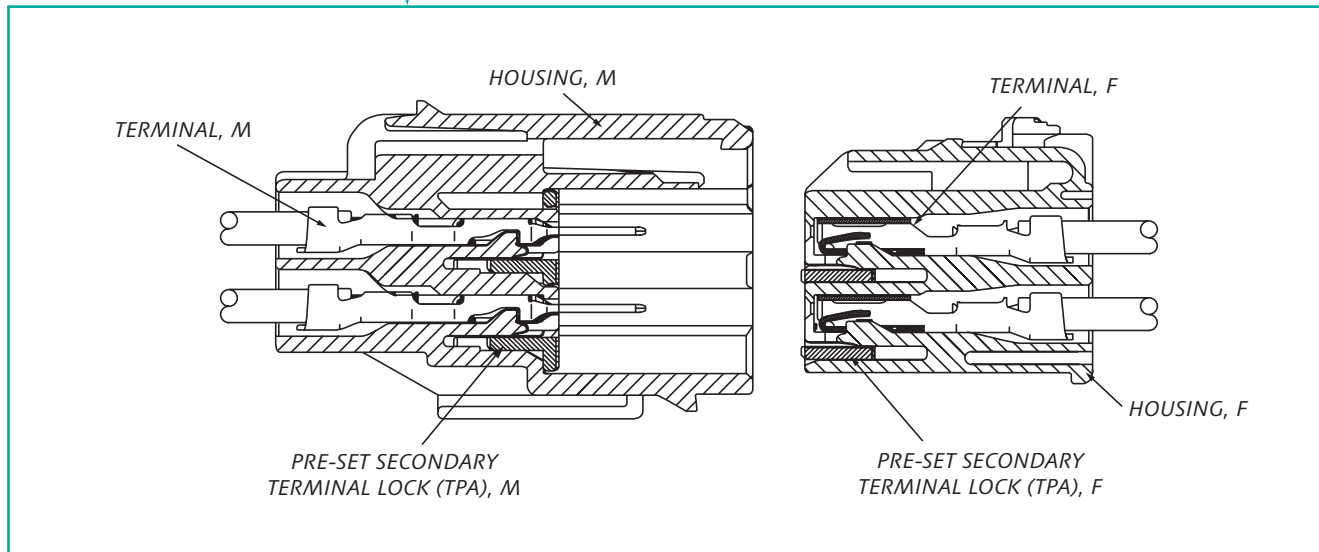

Specifications

Material	Connector	PBT+GF
	Male Terminal	Copper Alloy (Sn Plate)
	Female Terminal	Copper Alloy (Sn Plate)
Operating Temperature Range		-40°C ~ 125°C (145°C max temp.) (USCAR Class III)
Current Capacity		(See Chart)
Voltage Drop		10mΩ max (Term./Term.) (Crimp-To-Crimp)
Isolation Resistance		500VDC, 20MΩ min
Dielectric Resistance		1000VAC (1 minute)
Applicable Wire Size		20AWG ~ 12AWG (0.50mm ² ~ 4.0mm ²)
Terminal Pitch		Horizontal: 8.50mm; Vertical: 7.30mm
Terminal-to-Connector Retention Force		90N min
Connector-to-Connector Retention Force		110N min

Current Rating Curve (Reference Only)

This data is based on single circuit/connector evaluation. Data should be used as reference only. Appropriate derating should be considered based upon specific application requirements.

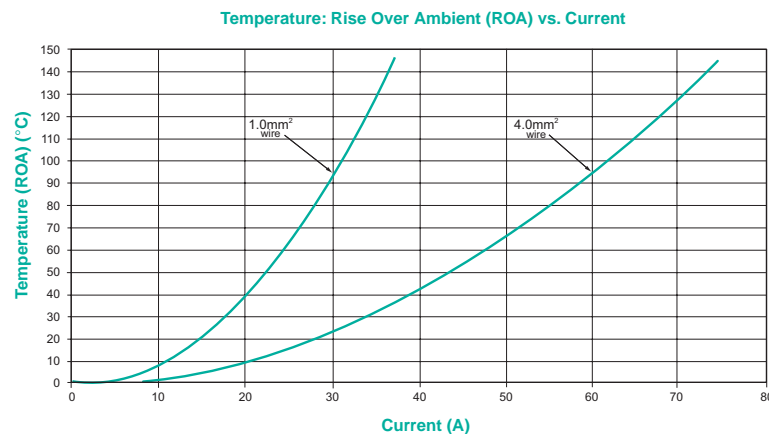

unsealed connection system

6.3 x 0.8

Terminal

UNIT: mm

Male Terminal

Material: Copper Alloy Thickness: t=0.4

Female Terminal

Material: Copper Alloy Thickness: t=0.4

Description	Part Number	Plating	Applicable Wire Size		
			Europe (mm ²)	U.S.A. (AWG)	Japan (mm ²)
Male Terminal	7114-4120-02	Sn	0.5 ~ 1.0	20 ~ 16	0.5 ~ 1.25
	7114-4121-02	Sn	1.5 ~ 2.5	14	2.0
	7114-4122-02	Sn	4.0	12	3.0
Female Terminal	7116-4120-02	Sn	0.5 ~ 1.0	20 ~ 16	0.5 ~ 1.25
	7116-4121-02	Sn	1.5 ~ 2.5	14	2.0
	7116-4122-02	Sn	4.0	12	3.0

Retainer Clip/Bracket Dimensions

UNIT: mm

Part Number	Panel Hole Requirements
7047-9580 (Ref)	φ6.5mm

Part Number Summary Chart

Part Name	Male	Female
Terminal	7114-4120-02	7116-4120-02
	7114-4121-02	7116-4121-02
	7114-4122-02	7116-4122-02
Applicable Clip	7047-9580 (Ref)	—

Pole	Polarity	Color/Description	YESC Male Part Number	YESC KAIZEN Male Part Number	YESC Female Part Number	YESC KAIZEN Female Part Number
2	A	Light Grey	—	7282-6458-40	—	7283-6458-40
4	A	Light Grey	—	7282-6469-40	—	7283-6469-40
6	A	Light Grey	7282-5604-40	—	—	7283-3740-40
6	B	Green	—	—	—	7283-3741-60

Applicable Terminal Removal Tool/Dimensions

Refer to Page 120 for YESC KAIZEN Connector Terminal Removal Tool. Order Number: G0406 (PA Type).

6.3 x 0.8

unsealed connection system

Housing Material: PBT+GF

UNIT: mm

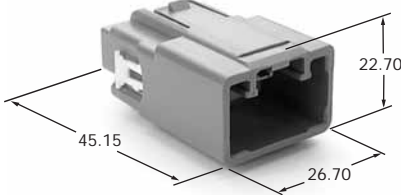
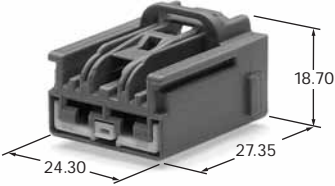
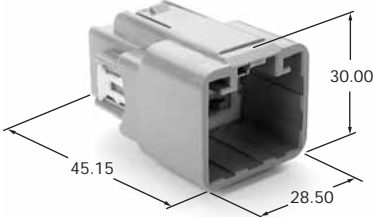
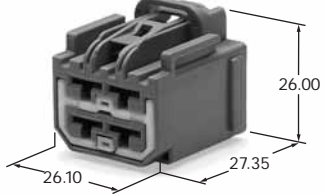
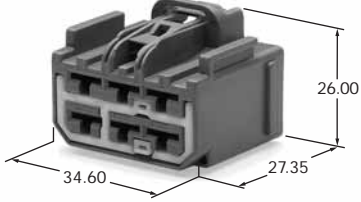
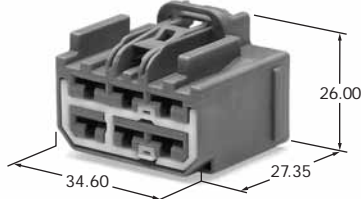
Poles	Male Housing	Female Housing
2	 <p>7282-6458-40</p>	 <p>7283-6458-40*</p>
4	 <p>7282-6469-40</p>	 <p>7283-6469-40</p>
6	N/A	 <p>7283-3740-40</p>
6	N/A	 <p>7283-3741-60</p>

* Part meets USCAR interface standard at time of printing.

YESC KAIZEN

CONNECTORS

9.5

SERIES

SEALED

CLICK ON YOUR SELECTION:

- CONSTRUCTION
- SPECIFICATIONS
- CURRENT RATING CURVE
- TERMINAL
- CABLE SEAL & CAVITY PLUG
- RETAINER CLIP/BRACKET DIMENSIONS
- PART NUMBER SUMMARY CHART
- PHOTOS/DIMENSIONS
- NAVIGATION TIPS

9.5 SERIES
SEALED

SUPPLEMENT TO YESC CATALOG

9.5 x 1.2

sealed connection system

Construction

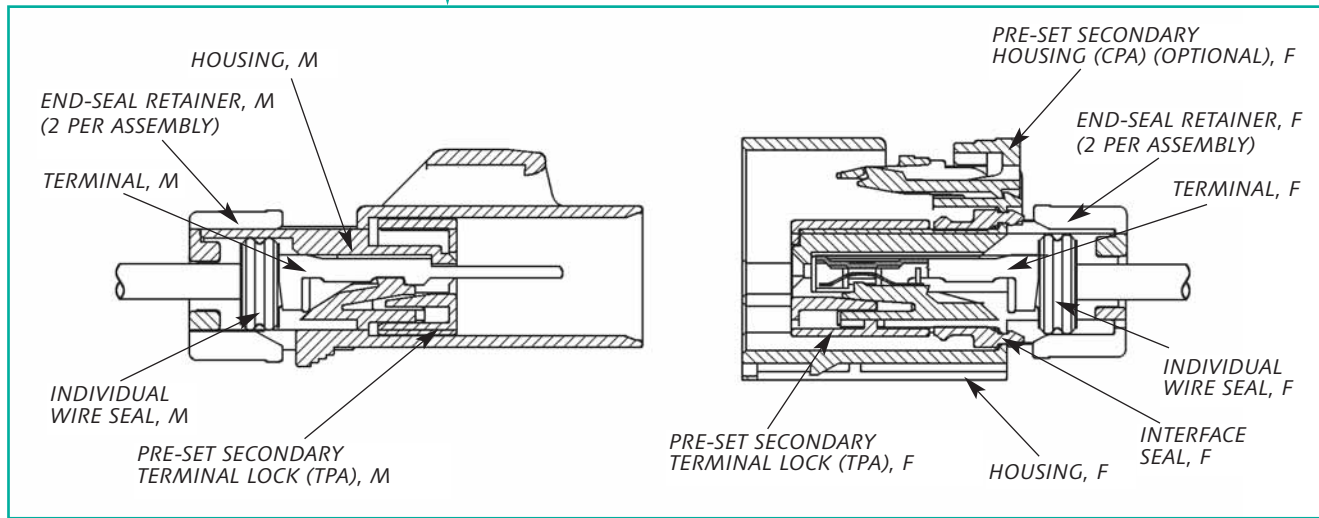

Specifications

Material	Connector	PBT+GF
	Male Terminal	Copper Alloy (Sn Plate)
	Female Terminal	Copper Alloy (Sn Plate)
Operating Temperature Range		-40°C ~ 125°C (145°C max temp.) (USCAR Class III)
Current Capacity		(See Chart)
Voltage Drop		10mΩ max (Term./Term.) (Crimp-to-Crimp)
Isolation Resistance		500VDC, 20MΩ min
Dielectric Resistance		1000VAC (1 minute)
Applicable Wire Size		12AWG ~ 8AWG (4mm ² ~ 8mm ²)
Terminal Pitch		Horizontal: 14.00 mm
Sealing Performance (Air-Leak Pressure)		48KPa min (Pre-Heat Soak); 28KPa (Post-Heat Soak)
Terminal-to-Connector Retention Force		90N min
Connector-to-Connector Retention Force		110N min

Current Rating Curve (Reference Only)

This data is based on single circuit/connector evaluation. Data should be used as reference only. Appropriate derating should be considered based upon specific application requirements.

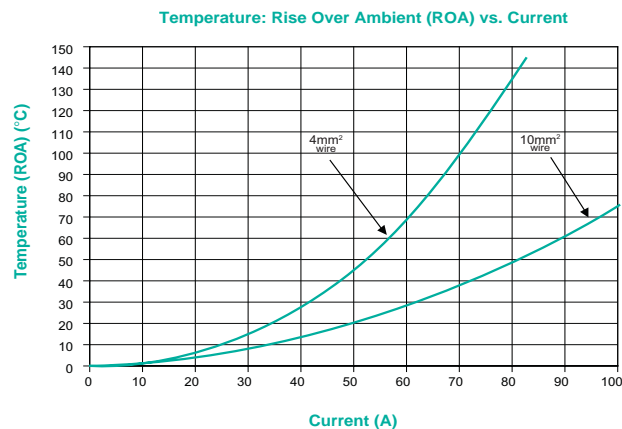

sealed connection system

9.5 x 1.2

Terminal

UNIT: mm

Male Terminal

Material: Copper Alloy Thickness: t=0.6

Female Terminal

Material: Copper Alloy Thickness: t=0.6

Description	Part Number	Plating	Applicable Wire Size		
			Europe (mm ²)	U.S.A. (AWG)	Japan (mm ²)
Male Terminal	7114-3273-02	Sn	10	8	10
	7114-3250	Sn	6	10	6
	7114-3251	Sn	4	12	4
Female Terminal	7116-3285-02	Sn	10	8	10
	7116-3250	Sn	6	10	6
	7116-3251	Sn	4	12	4

Cable Seal & Cavity Plug

UNIT: mm

Description	Part Number	Color	Material	Wire O.D. Range
Cable Seal	7157-3581-80	Orange	Silicone	4.3 ~ 5.8
	7157-3580-60	Green	Silicone	3.4 ~ 4.6
	7157-3582-90	Blue	Silicone	2.5 ~ 3.5
Unused Cavity Plug	7157-3583	Black	Silicone	—

Retainer Clip/Bracket Dimensions

UNIT: mm

Part Number	Panel Hole Requirements
7047-9580 (Ref)	φ6.5mm

Applicable Terminal Removal Tool/Dimensions

Refer to Page 120 for YESC KAIZEN Connector Terminal Removal Tool.
Order Number: G0406 (PA Type).

9.5 x 1.2

sealed connection system

Part Number Summary Chart

Part Name	Male	Female
<i>Terminal</i>	7114-3273-02	7116-3285-02
	7114-3250	7116-3250
	7114-3251	7116-3251
<i>Cable Seal</i>	7157-3581-80	
	7157-3580-60	
	7157-3582-90	
<i>Unused Cavity Plug</i>	7157-3583	
<i>Applicable Clip</i>	—	7047-9580 (Ref)
<i>End-Seal Retainer</i>	7158-6174-40	7158-6174-40

Pole	Polarity	Color/Description	Male Part Number	Female Part Number	Delete Caps
2	A	Black	7282-3214-30	7283-3214-30	—

Housing Material: PBT+GF

UNIT: mm

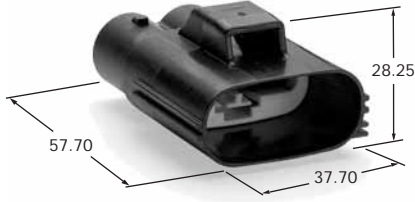
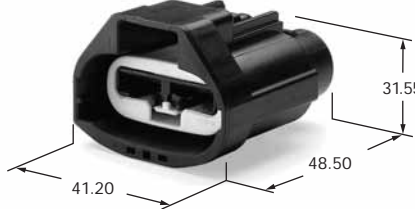
Poles	Male Housing	Female Housing
2	 <p>7282-3214-30</p>	 <p>7283-3214-30</p>

YESC KAIZEN

CONNECTORS

**BACK TO YESC KAIZEN
CONTENTS MENU**

Hybrid

SERIES

CLICK ON YOUR SELECTION:

SPECIFICATIONS

TERMINAL

RETAINER CLIP/BRACKET DIMENSIONS

PART NUMBER SUMMARY CHART

PHOTOS/DIMENSIONS

NAVIGATION TIPS

**HYBRID
SERIES**

SUPPLEMENT TO YESC CATALOG

HYBRID

connection system

Specifications

Material	Connector	PBT+GF
	Male Terminal	Copper Alloy (Sn/Au Plate)
	Female Terminal	Copper Alloy (Sn/Au Plate)
Operating Temperature Range		-40°C ~100°C (120°C max temp.) (USCAR Class II)
Operating Temperature Range		-40°C ~125°C (145°C max temp.) (USCAR Class III)
Current Capacity		(See Chart)
Voltage Drop		10mΩ max (Term./Term.) (Crimp-to-Crimp)
Isolation Resistance		500VDC, 20MΩ min
Dielectric Resistance		1000VAC (1 minute)
Applicable Wire Size		See Specific Connector Section
Terminal-to-Connector Retention Force		See Specific Connector Section
Connector-to-Connector Retention Force		See Specific Connector Section

Terminal

UNIT: mm

Description	YESC Part Number	YESC KAIZEN Part Number	Plating	Applicable Wire Size			
				Europe (mm ²)	U.S.A. (AWG)	Japan (mm ²)	
Male Terminal	1.5mm	7114-4100-02/-08	—	Sn/Au	0.35 ~ 0.5	22 ~ 20	0.3 ~ 0.5
		7114-4101-02/-08	—	Sn/Au	0.75 ~ 1.0	18 ~ 16	0.85 ~ 1.25
	2.8mm	7114-4110-02	—	Sn	0.35 ~ 0.5	22 ~ 20	0.3 ~ 0.5
		7114-4111-02	—	Sn	0.75 ~ 1.0	18 ~ 16	0.85 ~ 1.25
		7114-4112-02	—	Sn	1.5 ~ 2.5	14	2.0
	6.3mm	7114-4120-02	—	Sn	0.5 ~ 1.0	20 ~ 16	0.5 ~ 1.25
		7114-4121-02	—	Sn	1.5 ~ 2.5	14	2.0
		7114-4122-02	—	Sn	4.0	12	3.0
	Female Terminal	1.5mm	7116-4100-02	7116-4780-02	Sn	0.35 ~ 0.5	22 ~ 20
7116-4100-08			—	Au	0.35 ~ 0.5	22 ~ 20	0.3 ~ 0.5
7116-4101-02			7116-4781-02	Sn	0.75 ~ 1.0	18 ~ 16	0.85 ~ 1.25
7116-4101-08			—	Au	0.75 ~ 1.0	18 ~ 16	0.85 ~ 1.25
2.8mm		7116-4110-02	7116-4270-02	Sn	0.35 ~ 0.5	22 ~ 20	0.3 ~ 0.5
		7116-4111-02	7116-4271-02	Sn	0.75 ~ 1.0	18 ~ 16	0.85 ~ 1.25
		7116-4112-02	7116-4272-02	Sn	1.5 ~ 2.5	14	2.0
6.3mm		7116-4120-02	—	Sn	0.5 ~ 1.0	20 ~ 16	0.5 ~ 1.25
		7116-4121-02	—	Sn	1.5 ~ 2.5	14	2.0
		7116-4122-02	—	Sn	4.0	12	3.0

There are many different terminals and cable seals that can be used with Hybrid connectors. Please refer to the terminal and cable seal pages for 1.5, 2.8 and 6.3 sealed and unsealed connectors. If you have questions, please call 1-888-942-9152 for assistance.

HYBRID

connection system

Retainer Clip/Bracket Dimensions

UNIT: mm

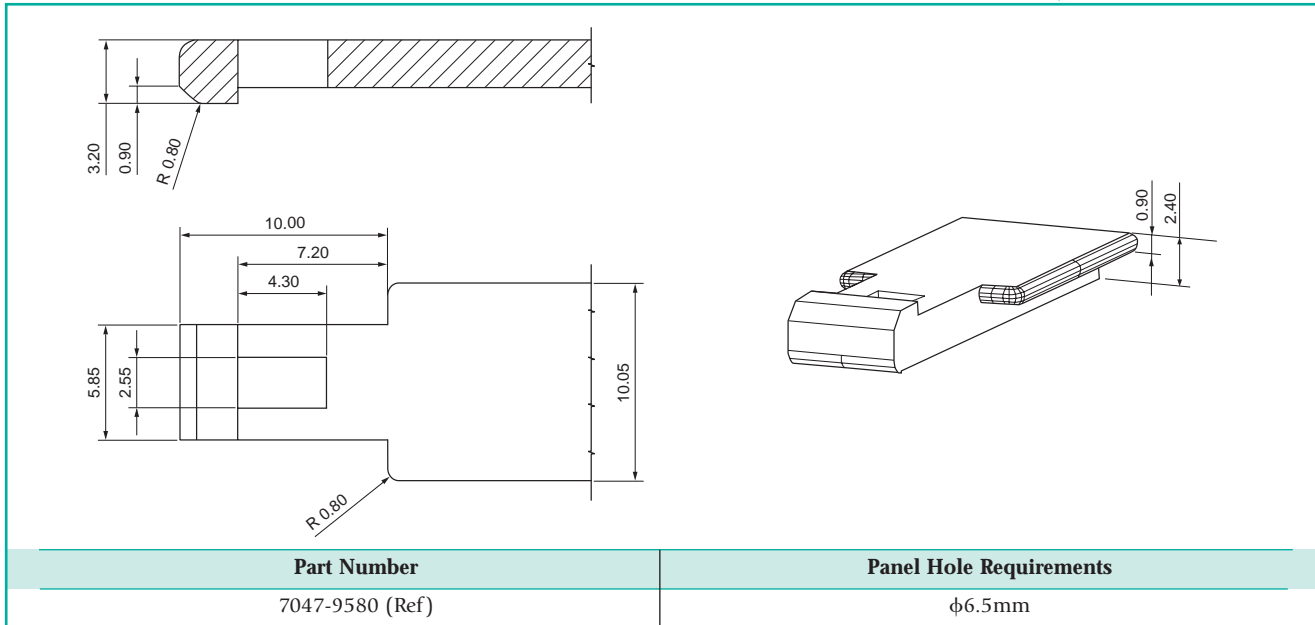

Part Number Summary Chart

Part Name	YESC Male Part Number	YESC KAIZEN Male Part Number	YESC Female Part Number	YESC KAIZEN Female Part Number	
Terminal	1.5mm	7114-4100-02	—	7116-4100-02	7116-4780-02
		7114-4100-08	—	7116-4100-08	—
		7114-4101-02	—	7116-4101-02	7116-4781-02
		7114-4101-08	—	7116-4101-08	—
	2.8mm	7114-4110-02	—	7116-4110-02	7116-4270-02
		7114-4111-01	—	7116-4111-02	7116-4271-02
		7114-4112-02	—	7116-4112-02	7116-4272-02
	6.3mm	7114-4120-02	—	7116-4120-02	—
		7114-4121-02	—	7116-4121-02	—
		7114-4122-02	—	7116-4122-02	—
	Applicable Clip	7047-9580 (Ref)	—	—	—

HYBRID

connection system

Part Number Summary Chart (cont.)

Pole	Polarity	Color/Description	YESC Male Part Number	YESC KAIZEN Male Part Number	YESC Female Part Number	YESC KAIZEN Female Part Number
8	A	Light Grey 6 x1.5, 2x2.8	—	7282-6448-40	—	7283-6448-40
10	A	Light Grey 6x1.5, 4x2.8	—	7282-6459-40	—	7283-6459-40
13	A	Black 9x0.64, 4x1.5	—	—	—	7283-3522-30
13	B	Light Grey 9x0.64, 4x1.5	—	—	—	7283-3523-40
13	A	Light Grey 11x2.8, 2x6.3	—	7282-6569-40	—	7283-6569-40
14	A	Black 12x0.64, 2x1.5	—	—	—	7283-4490-30
14	A	Light Grey 10x1.5, 4x2.8	—	7282-6447-40	—	7283-6447-40
14	A	Black 12x0.64, 2x1.5	—	—	—	7283-9281-30
20	A	Black 6x2.8, 14x1.5	—	7282-9450-30	—	7283-9450-30
28	A	Black 4x6.3, 24x0.64	—	—	—	7283-9504-30
34	A	Black 1x6.3, 6x2.8, 27x1.5	—	7282-9150-30	—	7283-9151-30
34	B	Light Grey 1x6.3, 6x2.8, 27x1.5	—	7282-9152-40	—	7283-9153-40
38	A	Black 30x0.64, 8.2.8	—	7282-2784-30	—	7283-2784-30
43	A	Black 34x1.5, 6x2.8, 3x6.3	—	7282-4190-30	—	7283-4190-30
43	B	Light Grey 34x1.5, 6x2.8, 3x6.3	—	7282-4192-40	—	7283-4192-40

Applicable Terminal Removal Tool/Dimensions

Refer to Page 120 for YESC KAIZEN Connector Terminal Removal Tool.
 Order Number: 49YA000263 (for 0.64 terminal), X39899-J374 (for 1.5 and 2.8 terminal),
 and G0406 (PA Type) (for 6.3 terminal).

connection system

HYBRID

Housing Material: PBT+GF

UNIT: mm

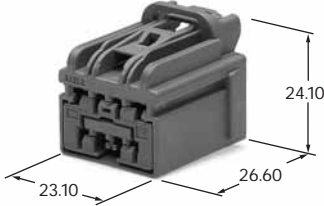
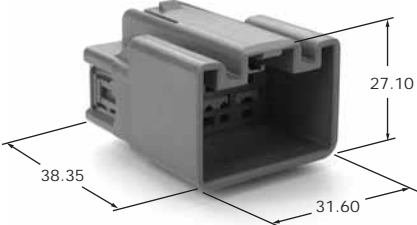
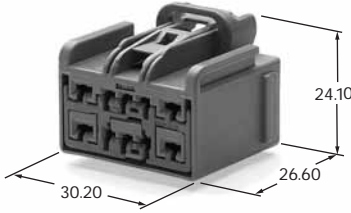
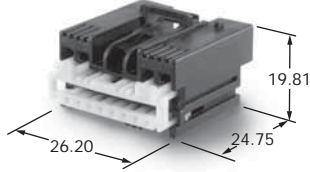
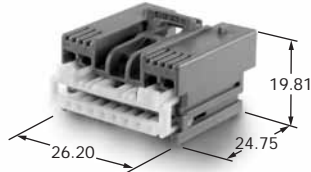
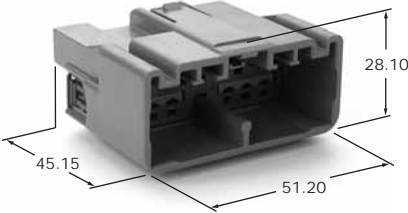
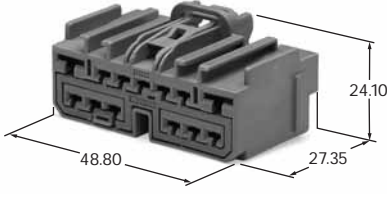
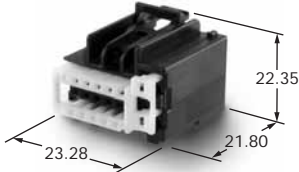
Poles	Male Housing	Female Housing
8	 <p>7282-6448-40</p>	 <p>7283-6448-40</p>
10	 <p>7282-6459-40</p>	 <p>7283-6459-40</p>
13	N/A	 <p>7283-3522-30</p>
13	N/A	 <p>7283-3523-40</p>
13	 <p>7282-6569-40</p>	 <p>7283-6569-40</p>
14	N/A	 <p>7283-4490-30</p>



GO TO PAGE 2 OF 3

HYBRID

connection system

Housing Material: PBT+GF

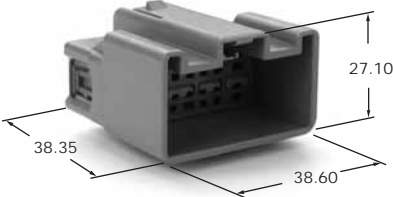
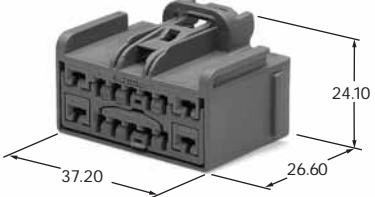
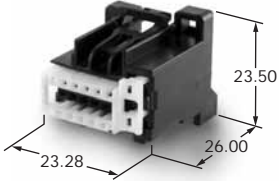
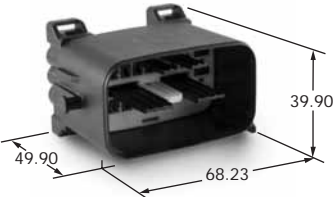
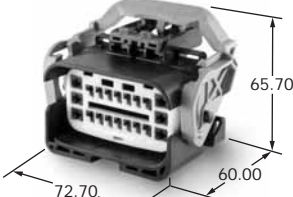
UNIT: mm

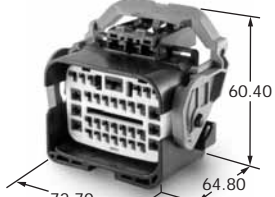

Poles	Male Housing	Female Housing
14	 <p>7282-6447-40</p>	 <p>7283-6447-40</p>
14	N/A	 <p>7283-9281-30</p>
20	 <p>7282-9450-30</p>	 <p>7283-9450-30</p>
28	N/A	 <p>7283-9504-30</p>
34	 <p>7282-9150-30</p>	 <p>7283-9151-30</p>

HYBRID

connection system

Housing Material: PBT+GF

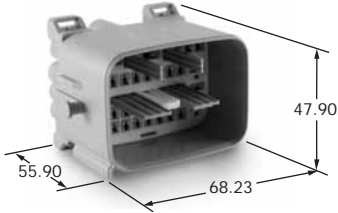
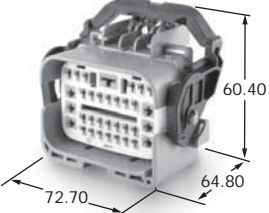
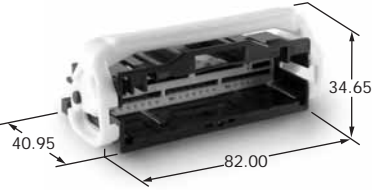
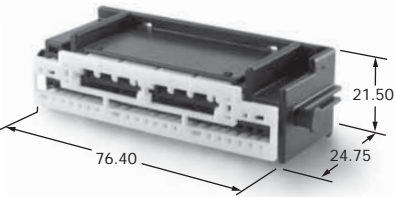
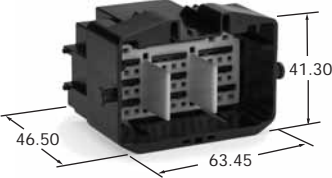
UNIT: mm

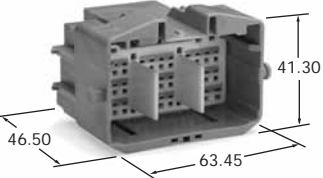
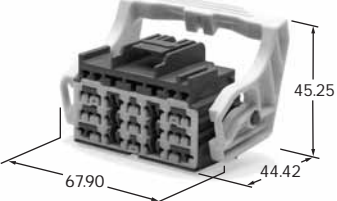
Poles	Male Housing	Female Housing
34	 <p>7282-9152-40</p>	 <p>7283-9153-40</p>
38	 <p>7282-2784-30</p>	 <p>7283-2784-30</p>
43	 <p>7282-4190-30</p>	 <p>7283-4190-30</p>
43	 <p>7282-4192-40</p>	 <p>7283-4192-40</p>

BACK TO YESC KAIZEN
CONTENTS MENU

YESC KAIZEN

CONNECTORS

Header SERIES

CLICK ON YOUR SELECTION:

CONSTRUCTION

SPECIFICATIONS

CURRENT RATING CURVE

TERMINAL

PART NUMBER SUMMARY CHART

PHOTOS/DIMENSIONS

NAVIGATION TIPS

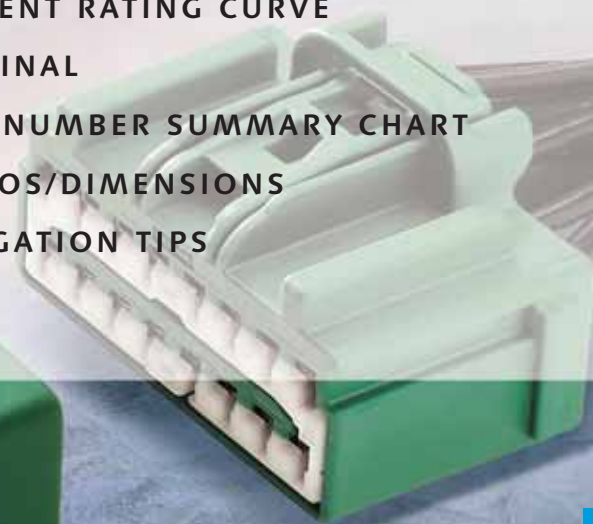
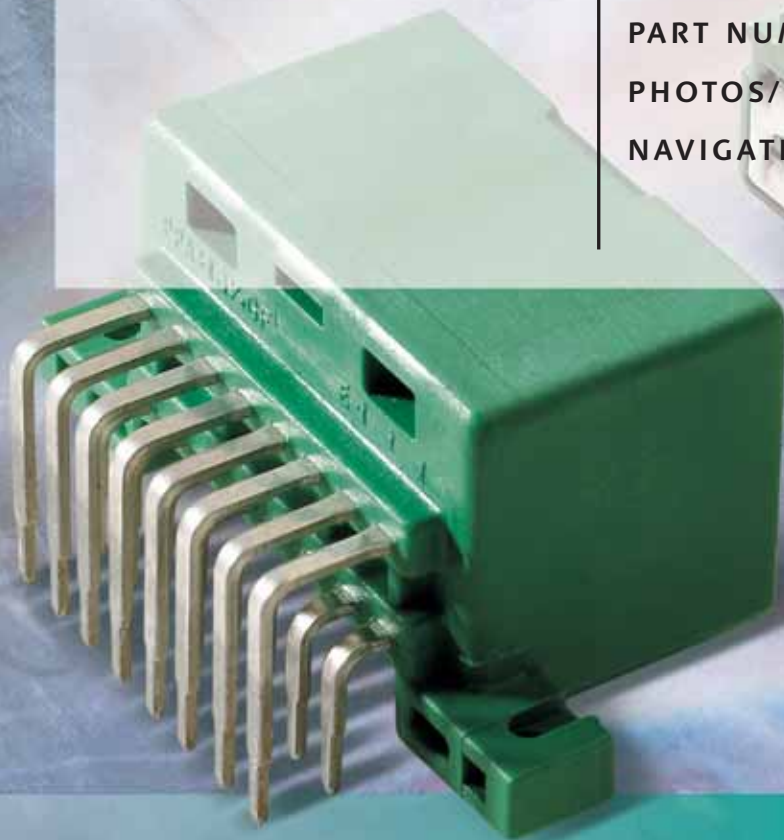

HEADER
SERIES

SUPPLEMENT TO YESC CATALOG

HEADER

connection system

Construction

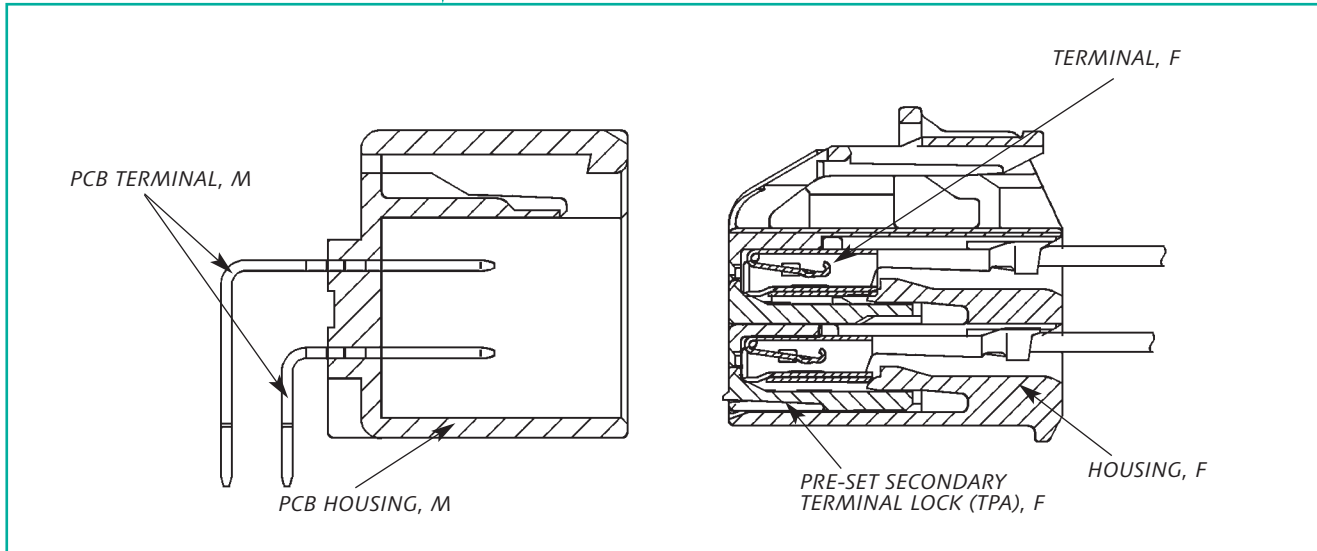

Specifications

Material	Connector	See Section
	Male Terminal	Brass (Sn Plate)
	Female Terminal	Copper Alloy (Sn/Au Plate)
Operating Temperature Range		-40°C ~100°C (125°C max temp.) (USCAR Class II)
Current Capacity		(See Chart)
Voltage Drop		10mΩ max (Term./Term.)
Isolation Resistance		500VDC, 20MΩ min
Dielectric Resistance		1000VAC (1 minute)
Terminal-to-Connector Retention Force		90N min
Connector-to-Connector Retention Force		110N min

Current Rating Curve

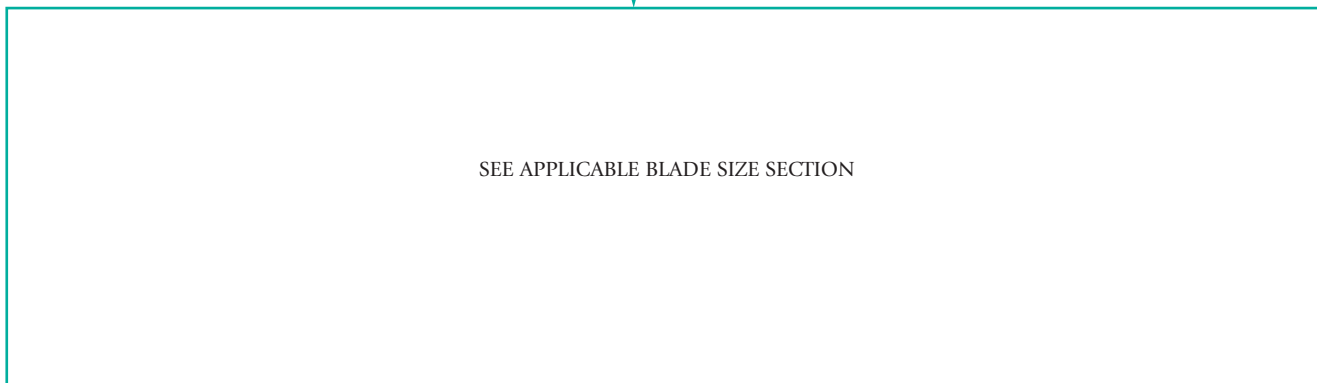

connection system

HEADER

Terminal

UNIT: mm

<i>Male PCB Terminal</i>			<i>Female Terminal</i>				
PURCHASED IN ASSEMBLY			SEE APPLICABLE BLADE SIZE SECTION				
<i>Material: Brass</i>			<i>Material: Copper Alloy</i>		<i>Thickness: t=0.3</i>		
Description	YESC Part Number	YESC KAIZEN Part Number	Plating	Applicable Wire Size			
				Europe (mm ²)	U.S.A. (AWG)	Japan (mm ²)	
<i>Male Terminal</i>	—	—	—	—	—	—	
<i>Female Terminal</i>	<i>1.5mm</i>	7116-4100-02	7116-4780-02	Sn	0.35 ~ 0.5	22 ~ 20	0.3 ~ 0.5
		7116-4100-08	—	Au	0.35 ~ 0.5	22 ~ 20	0.3 ~ 0.5
		7116-4101-02	7116-4781-02	Sn	0.75 ~ 1.0	18 ~ 16	0.85 ~ 1.25
		7116-4101-08	—	Au	0.75 ~ 1.0	18 ~ 16	0.85 ~ 1.25
	<i>2.8mm</i>	7116-4110-02	7116-4270-02	Sn	0.35 ~ 0.5	22 ~ 20	0.3 ~ 0.5
		7116-4111-02	7116-4271-02	Sn	0.75 ~ 1.0	18 ~ 16	0.85 ~ 1.25
		7116-4112-02	7116-4272-02	Sn	1.5 ~ 2.5	14	2.0
	<i>6.3mm</i>	7116-4120-02	—	Sn	0.5 ~ 1.0	20 ~ 16	0.5 ~ 1.25
7116-4121-02		—	Sn	1.5 ~ 2.5	14	2.0	
7116-4122-02		—	Sn	4.0	12	3.0	

HEADER

connection system

Part Number Summary Chart

Part Name	Male	YESC Female	YESC KAIZEN Female
Terminal	1.5mm	7116-4100-02	7116-4780-02
		7116-4100-08	---
		7116-4101-02	7116-4781-02
		7116-4101-08	---
	2.8mm	7116-4110-02	7116-4270-02
		7116-4111-02	7116-4271-02
		7116-4112-02	7116-4272-02
	6.3mm	7116-4120-02	---
		7116-4211-02	---
7116-4122-02		---	

Pole	Polarity	Color/Description	Male Part Number	YESC Female Part Number	YESC KAIZEN Female Part Number
2	A	Black 6.3mm Header	7382-5597-40		7283-6458-40
2	A	Light Grey 6.3mm Header	7282-5608-30		7283-6458-40
4	A	Black 6.3mm Header	7382-5613-30		7283-6469-40
10	A	Light Grey 1.5mm Header	7382-5884-40		7283-6455-40
10	B	Black 1.5mm Header	7382-6379-30		7283-6455-40
12	A	Light Grey 2.8mm Header	7382-5568-40		7283-6467-40
12	A	Black 1.5mm Header	7382-5957-30		7382-5957-30
14	A	Light Grey 6.3mm Header	7382-5627-40		7283-6447-40
16	A	Green/Config 1 1.5mm Header	7382-5551-60		7283-6453-60
16	A	Green/Config 2 1.5mm Header	7382-5681-60		7283-6453-60
16	A	Green/Config 3 1.5mm Header	7382-5682-60		7283-6453-60
32	A	Black 1.5mm Header	7382-5552-30		7283-6456-90 7283-3585-40
32	B	Light Grey 1.5mm Header	7382-5881-40		7283-6456-90 7283-3585-40





Applicable Terminal Removal Tool/Dimensions

Refer to Page 120 for YESC KAIZEN Connector Terminal Removal Tool.
Order Number: X39899-J374 (for 1.5 and 2.8 terminal) and G0406 (PA Type) (for 6.3 terminal).

HEADER

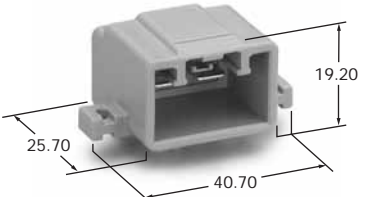
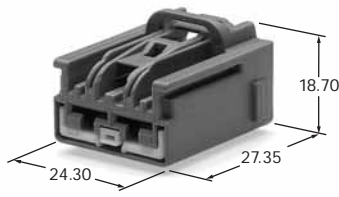
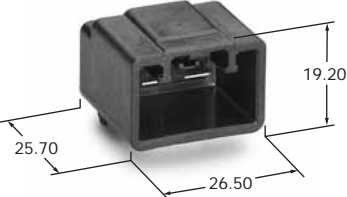
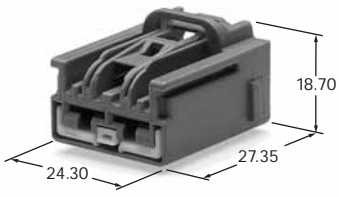
connection system

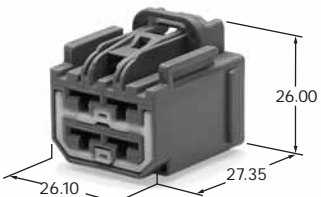
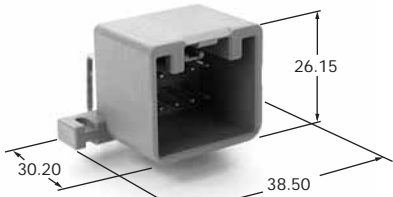
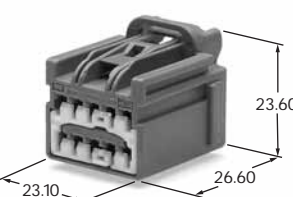
Housing Material: PPA-GF16 Material: PBT+GF UNIT: mm

Poles	Male Housing	Female Housing
2	 <p>7382-5597-40*</p>	 <p>7283-6458-40*</p>
2	 <p>7382-5608-30*</p>	 <p>7283-6458-40*</p>
4	 <p>7382-5613-30</p>	 <p>7283-6469-40</p>
10	 <p>7382-5884-40*</p>	 <p>7283-6455-40*</p>
10	 <p>7382-6379-30*</p>	 <p>7283-6455-40*</p>

* Part meets USCAR interface standard at time of printing.

HEADER

connection system

Housing Material: PPA-GF16

Material: PBT+GF

UNIT: mm

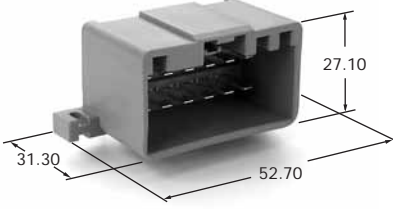
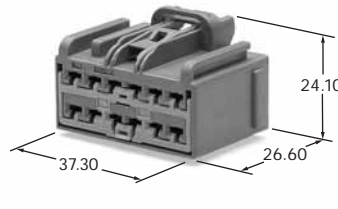
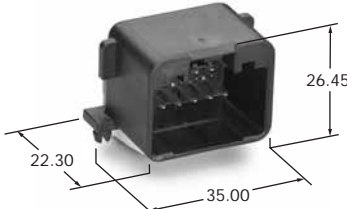
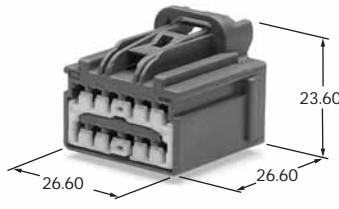
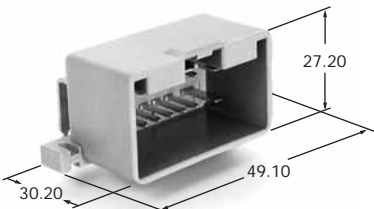
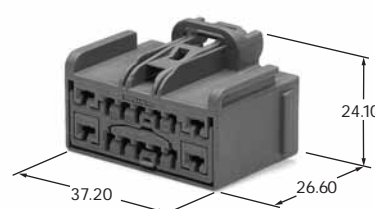
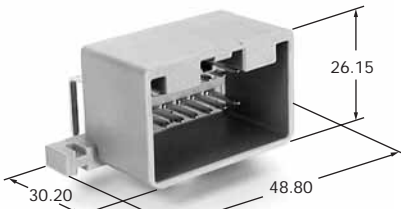
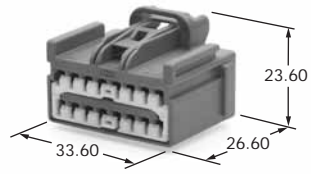
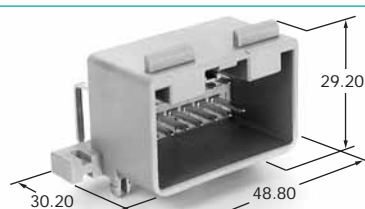
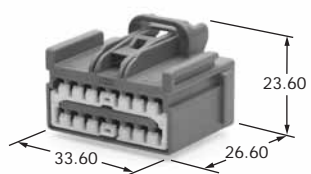
Poles	Male Housing	Female Housing
12	 <p>7382-5568-40</p>	 <p>7283-6467-40</p>
12	 <p>7382-5957-30*</p>	 <p>7382-5957-30*</p>
14	 <p>7382-5627-40</p>	 <p>7283-6447-40</p>
16	 <p>7382-5551-60*</p>	 <p>7283-6453-60*</p>
16	 <p>7382-5681-60*</p>	 <p>7283-6453-60*</p>

* Part meets USCAR interface standard at time of printing.

connection system

HEADER

Housing Material: PPA-GF16

Material: PBT+GF

UNIT: mm

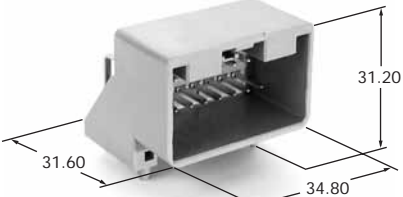
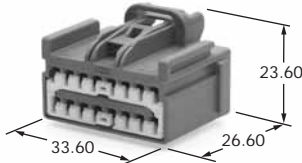
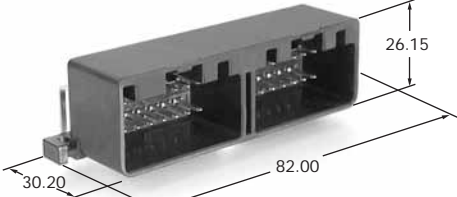
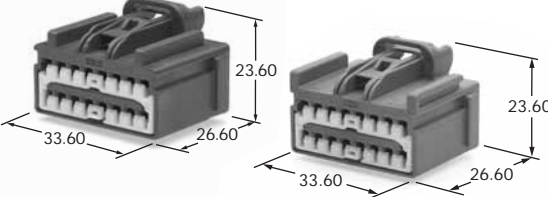
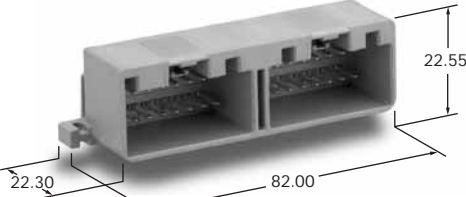
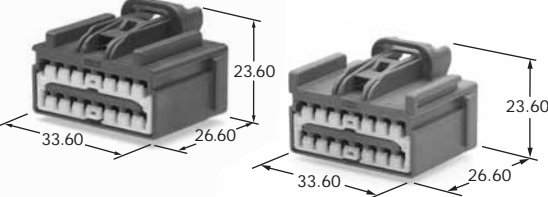
Poles	Male Housing	Female Housing
16	 <p>7382-5682-60*</p>	 <p>7283-6453-60*</p>
32	 <p>7382-5552-30*</p>	 <p>7283-6456-90 (16P)* 7283-3585-40 (16P)*</p>
32	 <p>7382-5881-40*</p>	 <p>7283-6456-90 (16P)* 7283-3585-40 (16P)*</p>

* Part meets USCAR interface standard at time of printing.

YESC KAIZEN

CONNECTORS

Terminal REMOVAL

CLICK ON YOUR SELECTION:

TOOL FOR 0.64 SERIES

TOOL FOR 1.5 AND 2.8 SERIES

TOOL FOR 6.3 AND 9.5 SERIES



TERMINAL
REMOVAL

SUPPLEMENT TO YESC CATALOG

TERMINAL REMOVAL

Applicable Terminal Removal Tool/Dimensions

UNIT: mm

Description	Order Number
YESC KAIZEN Connector Terminal Removal Tool for 0.64 series.	49YA000263

UNIT: mm

Description	Order Number
YESC KAIZEN Connector Terminal Removal Tool for 1.5 and 2.8 series.	X39899-J374

UNIT: mm

Description	Order Number
YESC KAIZEN Connector Terminal Removal Tool for 6.3 and 9.5 series.	G0406 (PA Type)

PART NUMBERING METHODOLOGY

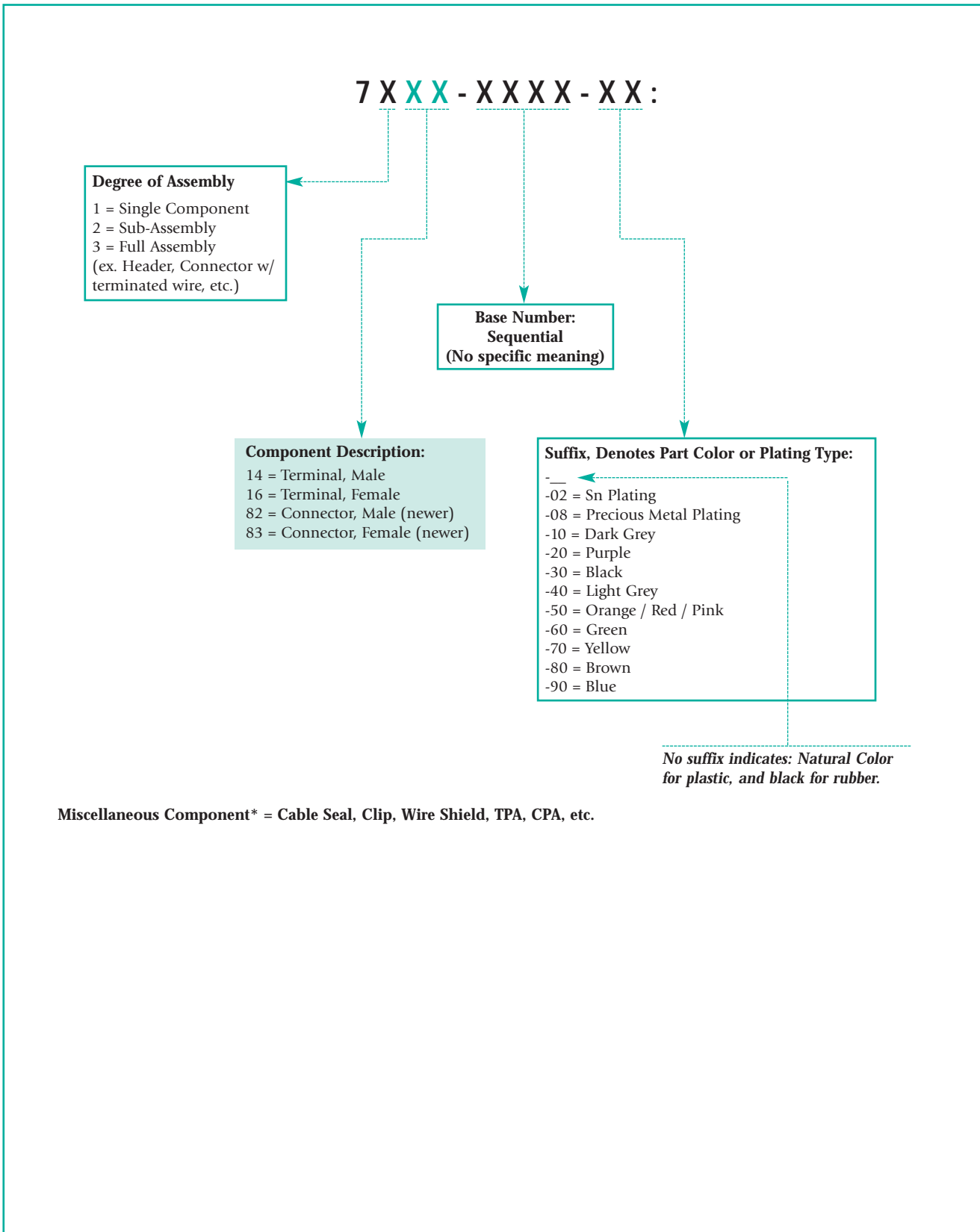

BACK TO YESC CONTENTS MENU
BACK TO YESC KAIZEN CONTENTS MENU

DISCLAIMER: The information contained in this catalog is for reference purposes only, is subject to change without notice, and is not guaranteed by Yazaki Corporation, Yazaki North America Inc., Yazaki Europe Limited or any other Yazaki group company (collectively referred to as "Yazaki"). Yazaki makes no warranty as to the completeness or accuracy of the information contained herein, and is not responsible for any typographical or printing errors. Current specifications for individual products should be obtained by potential customers in connection with placing orders for products with Yazaki.

The customer, among other matters, is solely responsible for determining the fitness or suitability of any product of Yazaki for the purpose intended by the customer and for all design and related matters.

Yazaki makes no warranty, express or implied, with respect to any product referred to in this catalog, except such express warranty. If any as may be specifically agreed to by Yazaki in a written agreement signed and delivered by an authorized representative of Yazaki for the sale of such product, and any such express warranty shall be the sole and exclusive liability of Yazaki. Yazaki makes no other warranty. Whether express, implied, statutory or otherwise, including but not limited to any warranty of merchantability or fitness for any particular use, purpose or otherwise with respect to such products.

SEPTEMBER 2005

© 2005 Yazaki North America, Inc.

[BACK TO MAIN MENU](#)**NORTH AMERICA****Headquarters:**

6801 Haggerty Road,
Canton, MI 48187, USA
734.983.1000
888.942.9152

El Paso Division:

1265 Peter Cooper, CIMS 711-00-00
El Paso, Texas 79936, USA
915.858.8100

ASIA & SOUTH AMERICA**Singapore Component PET, LTD.:
(SINCOM)**

79 Anson Road #08-01
SINGAPORE 079906
65.622.6.6910

Japan:

World Headquarters
Component Operations:
1500 Mishuku, Susono-City
Shizuoka-Ken
410-1194 JAPAN
81.559.65.3026

EUROPE**Components Business Unit**

Cologne:
Robert-Bosch-Strasse 43
D-50769 Cologne, GERMANY
49.221.59799.0

Components Business Unit

Croatia:
HR-10000 Zagreb
Budmanijeva 1
Zagreb, CROATIA
385.1.6323.100

Hemel Hempstead:

Unit 1. The Willows, Mark Road
Hemel Hempstead, Hertfordshire
HP1 7AV UNITED KINGDOM
44.1442.29.2400

Belgium:

Bedrijfsstraat 1220, B-3660
Opglabbeek, BELGIUM
32.89.85.21.40

Barcelona:

Gran Via de Les Corts Catalanes 184
Atico 2A,
E-08038 Barcelona, SPAIN
34.93.432.9200

Gothenburg:

Exportgatan 38B
SE-422 46 Hisings-Backa, SWEDEN
46.31.742.0600

Torino:

Via Leonardo da Vinci, 29
I-10095 Grugliasco
Torino, ITALY
39.011.780.4848

www.yazaki-na.com
888.942.9152



X-ON Electronics

Largest Supplier of Electrical and Electronic Components

Click to view similar products for [Automotive Connectors](#) category:

Click to view products by [Yazaki](#) manufacturer:

Other Similar products are found below :

[003-018-000](#) [60993906-B](#) [M902-2131](#) [M902-2161](#) [M902-2344](#) [72.330.1035.1](#) [73.353.4028.0](#) [F166900](#) [F358300-B](#) [F407400](#) [776880-1](#)
[827153-1](#) [8N1515-32-24P](#) [9-1326729-8](#) [925474-1](#) [928905-1](#) [964562-4](#) [968782-1](#) [98891-1012](#) [12004475-L](#) [12020308](#) [12041318-B](#)
[12052466](#) [12064869](#) [12015909](#) [1-21030-1](#) [12041254](#) [12041318](#) [12047946-B](#) [12110546-B](#) [12131792](#) [12084688](#) [12092346](#) [HD34-18-14PT](#)
[HD46-24-23SN-059](#) [HDB36-24-16PN-059](#) [HDP26-24-9SE-L015](#) [12185280](#) [12185550](#) [12336-12](#) [12191172-B](#) [12S](#) [13545280](#) [13577943](#)
[13681974](#) [13737722-B](#) [13830674](#) [13832576](#) [13849772](#) [13542772](#)