

# Mechanicals Dimensions

REV.	DESCRIPTION	DATE	DWN	AP'PD

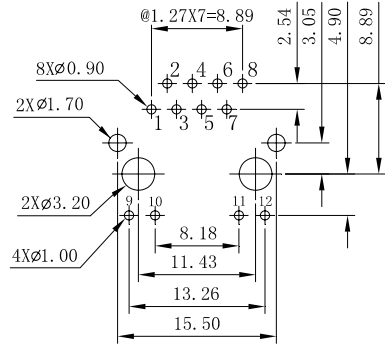

PC Board Layout  
Component Side Shown

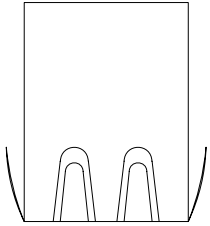
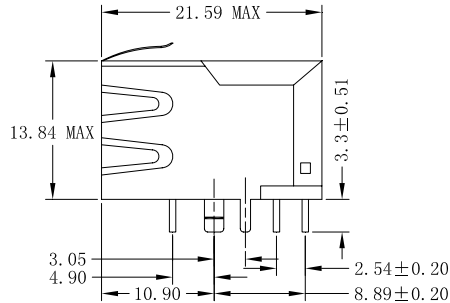
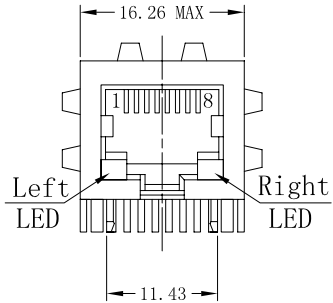

UNIT: mm Unless otherwise specified, all tolerances are ±0.25

## ELECTRICAL SPECIFICATIONS@25°C:

**Turn Ratio(±5%):**TX&RX=1CT:1CT

**Inductance(100KHz/0.1V@8mA):**350uH MIN

**Insertion Loss (dB MAX):**-1.0dB(0.3-100MHz)

**Return Loss (dB MIN):**

-18dB(1-30MHz), -16dB(40MHz), -12dB(50MHz), -10dB(60-80MHz)

**Cross talk(dB MIN):**

-40dB(30MHz), -35dB(60MHz), -30dB(100MHz)

**CMR (dB MIN):**

-30dB(30MHz), -20dB(60MHz), -20dB(100MHz)

**HI-POT:**1500Vrms/0.5mA/2Sec

**Operating Temperature:**-40°C TO +85°C

**RoHS compliance:**YES

## Schematics

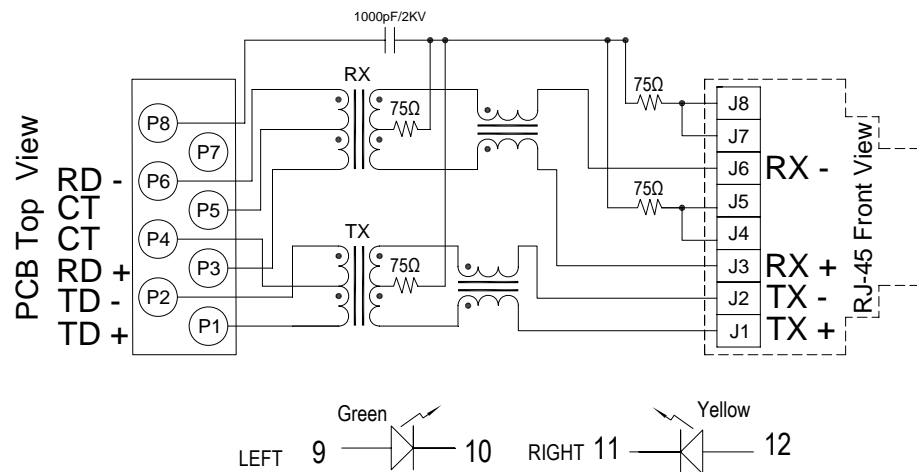

Ref:BOM-AE45



 <b>元册科技股份有限公司</b> YUAN DEAN SCIENTIFIC CO., LTD.			
<b>TITLE</b>	<b>10/100 BASE-T SINGLE PORT RJ-45 JACK MAGNETICS</b>		
<b>P/N</b>	<b>13F-64GYD2PLXNL</b>	<b>REV.</b>	<b>0</b>
<b>PAGE NO</b>	<b>1-2</b>	<b>DATE</b>	<b>2008-7-30</b>
<b>AP'PD</b>	<b>Li YueSheng</b>	<b>DWN</b>	Chen JiaPei

# Mechanicals

## Housing Material:

MATERIAL:NYLON GF (Fr50) UL94V-0 STANDARD COLOR:BLACK

## Insert Material:

MATERIAL:Phos-Bronze C5210 EH---0.35mm Thickness

Insert -PBT GF UL94V-0

- 1.PLATING(1) NICKEL
- 2.PLATING(2) 100%Sn
- 3.PLATING(3) GOLD (3u " ~50u " )

## Plate Material:

PBT GF UL 94V-0

## Contact pin Material:

MATERIAL: Phos-Bronze C5210 EH---0.35mm Thickness

- 1.PLATING(1) NICKEL
- 2.PLATING(2) 100%Sn

## Shielding Material:

BRASS C2680 H.---0.25mm THICKNESS PLATING NICKEL

Operating Life:750 Cycles MIN.

## Environmental

- 1.Storage Temp:-40°C TO +85°C.
- 2.Operating Temp:-40°C TO +85°C.
- 3.Wave Soldering Temperature:230~250°C (3~5 SECONDS)
4. MATES WITH MODULAR PLUG CONFORMING TO FCC PART 68,SUBPART F.

## Part Number

13F-64GYD2PLXNL

RoHS version  
Gold Plating:1=3u",2=6u",3=15u",4=30u",5=50u",



REV.	DESCRIPTION	DATE	DWN	AP'PD

## Packaging

1. packaging unit : 60 PCS/tray
2. packaging material : PET

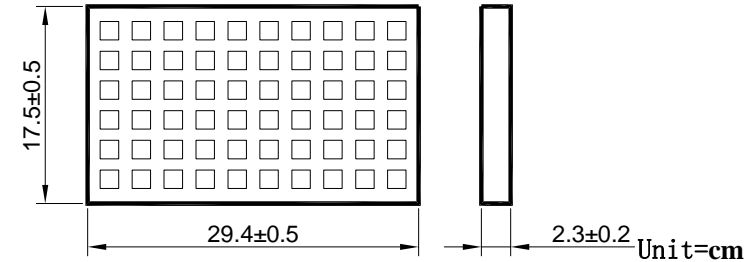
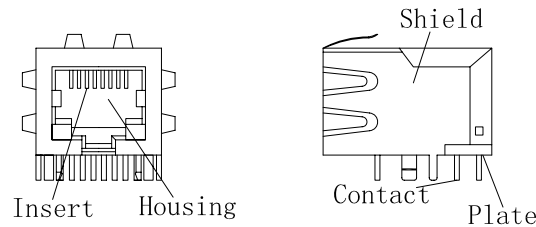

3. outer carton unit: 1320 pcs/ 22 Trays/box

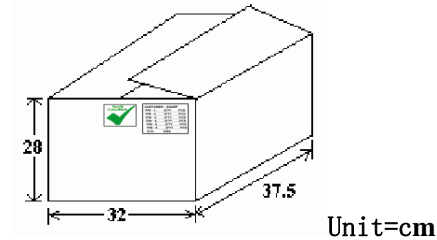

 <b>元册科技股份有限公司</b> YUAN DEAN SCIENTIFIC CO., LTD.		TITLE	
		10/100 BASE-T SINGLE PORT RJ-45 JACK MAGNETICS	
P/N	13F-64GYD2PLXNL	REV.	0
PAGE NO	2-2	DATE	2008-7-30
AP'PD	Li YueSheng	DWN	Chen JiaPei



## X-ON Electronics

Largest Supplier of Electrical and Electronic Components

*Click to view similar products for [Modular Connectors](#) / [Ethernet Connectors](#) category:*

*Click to view products by [YDS](#) manufacturer:*

Other Similar products are found below :

[8949-H88/06BLKA/SN](#) [74441-0010/BKN](#) [PHP-6P6C-5](#) [GAX-3-66](#) [GAX-8-62](#) [GDCX-PN-66](#) [GLX-A-44](#) [GLX-N-1010M-BLK](#) [GMX-SMT4-N-88](#) [GSGX-N-2-88](#) [GSGX-N-4-88](#) [GSX-NS2-88-3.05](#) [GSX-NS-88-3.68](#) [PT-108A-8C-UL](#) [PTS-J531-8CS-50UL](#) [1-1775629-2](#) [A-2014-0-4](#) [GWLX-S9-88-YG](#) [DC-1021-8-WH-6](#) [1300530003](#) [1324640-4](#) [RJ11FTVC2G](#) [RJ11FTVC2N](#) [RJFTVX2SA1G](#) [132764-001](#) [1413235](#) [MPS88RX-5000](#) [E5288-S000K3-L](#) [155302-001](#) [AX101050](#) [AX101063](#) [AX101065](#) [AX101072](#) [AX101307](#) [AX101314](#) [AX101315](#) [AX101318](#) [AX102271](#) [AX102288](#) [AX102651](#) [AX102660](#) [HXJ5EOR](#) [J0012D21NL](#) [J0026D01ENL](#) [PC4D0018P](#) [8949-B88/6](#) [2-6609208-5](#) [937-SP-3088-2PC-A192](#) [303066VFL](#) [303068V](#)