

一、外观尺寸图

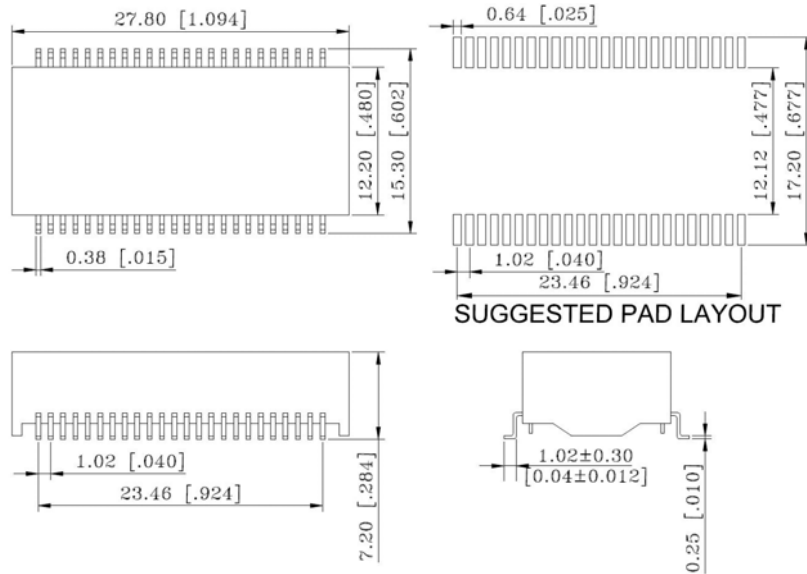

Unit:mm Unless otherwise specified, all tolerances are ±0.25

二、线路图

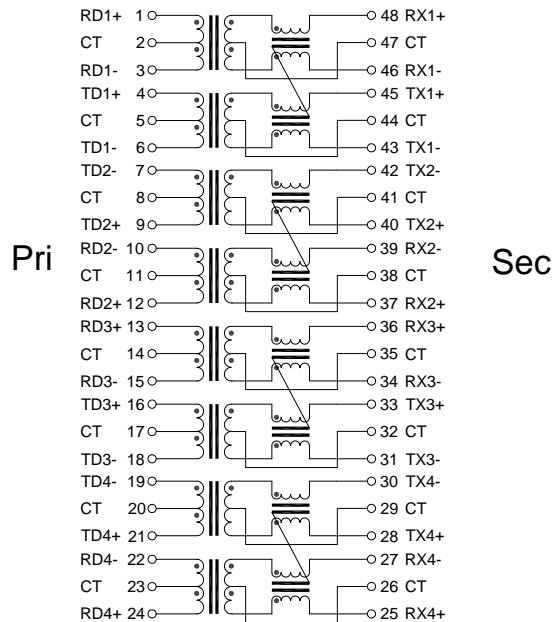

三、电气特性@25°C:

- 圈比(±3%): 1CT:1CT
- 电感(100KHz/0.1V@8mA): 350uH MIN
- 漏感(100KHz/0.2V): 0.5uH MAX
- 杂散电容(100KHz/0.2V): 28pF MAX
- 插入损耗(dB MAX): -1.0dB(1-100MHz)
- 反馈损耗(dB MIN): -18dB(1-30MHz), -14.4dB(40MHz), -13.1dB(50MHz), -12dB(60-80MHz), -10dB(80-100MHz)
- 串音干扰(dB MIN): -30dB(1-100MHz)
- 直流电阻: 1.2Ω MAX
- 耐压: 1500Vrms/1mA/2s
- 操作温度: -40°C TO +85°C
- 符合 IEEE 802.3at 标准
- 适用于端部 POE 应用电流能力: 750mA
- 符合 RoHS 标准

REV.	DESCRIPTION	DATE	DWN	AP'PD
1.0		15.1.6	Chen	Hsu
1.1	Correct Characteristic	16.7.14	Huang	Hsu
1.2	Add Packing	17.6.16	Zhou	Hsu



 元册科技股份有限公司 YUAN DEAN SCIENTIFIC CO., LTD.			
TITLE		100/1000BASE-T POE+ DUAL PORT SURFACE MOUNT MAGNETICS	
P/N	15FB-41GNL	REV.	1.2
PAGE NO	1-2	DATE	2017-6-16
AP'PD	Hsu	DWN	Zhou sheng mei

五、包装信息:

1. 单重----- 3.2克/个
2. 卷带----- 300个
3. 外箱单位: 1800个/箱
4. 外箱单位: 6卷/箱
5. 总重: 10.1 千克/箱

REV.	DESCRIPTION	DATE	DWN	AP'PD

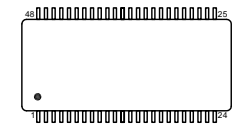

Mechanicals

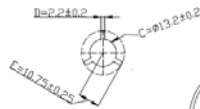
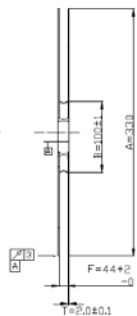
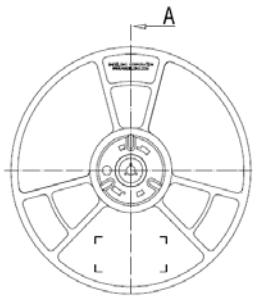
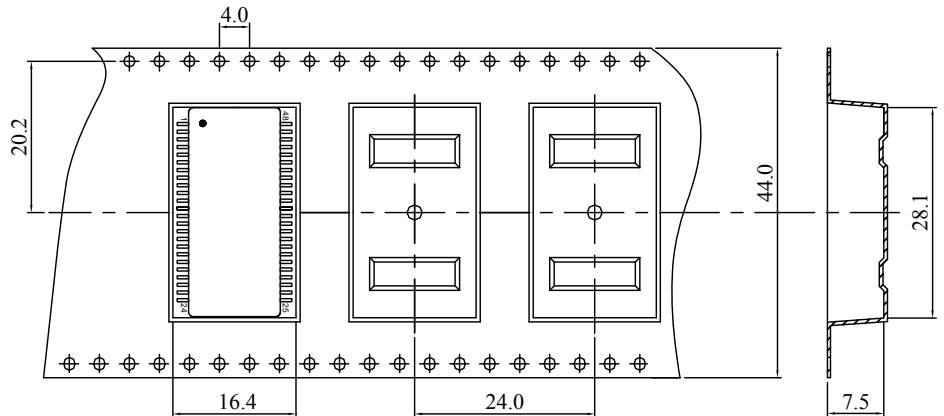

中心局部放大
2:3

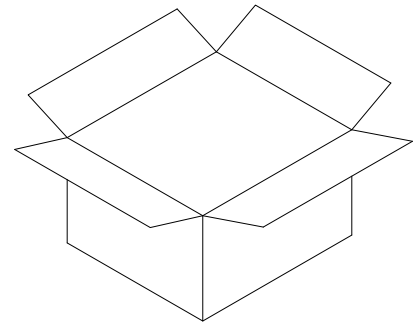

Outer carton: 365x365x350mm



元册科技股份有限公司

YUAN DEAN SCIENTIFIC CO., LTD.

TITLE

100/1000BASE-T POE+ DUAL PORT
SURFACE MOUNT MAGNETICS

P/N

15FB-41GNL

REV.

1.2

PAGE NO

2-2

DATE

2017-6-16

AP'PD

Hsu

DWN

Zhou sheng mei

X-ON Electronics

Largest Supplier of Electrical and Electronic Components

Click to view similar products for [Audio Transformers](#) / [Signal Transformers](#) category:

Click to view products by [YDS](#) manufacturer:

Other Similar products are found below :

[CU4S0506AT-2655-H1](#) [CX2041NLT](#) [MGPWT-00449-P](#) [PE-64961](#) [H1302FNLT](#) [H5008FNL](#) [H5012FNL](#) [H5020FNLT](#) [H5077NLT](#)
[H5079NLT](#) [H5084FNLT](#) [1812WBT2-4](#) [1879479-1](#) [HX2260FNL](#) [PA1528ANL](#) [EX2024FNL](#) [T1137NLT](#) [T3012NL](#) [PE-65812FNL](#) [PE-65848FNLT](#) [H1174FNL](#) [H1302FNL](#) [H5015FNL](#) [H5019EFNL](#) [H5062FNLT](#) [CX2045ALNLT](#) [CX2047LNL](#) [MET-14](#) [MGPWT-00059-P](#)
[MGPWT-00266-P](#) [MGPWT-00278-P](#) [MGPWT-00431-P](#) [TTC-100](#) [TTC-143-H](#) [BX1194WNLT](#) [HX1234NLT](#) [HX5008FNLT](#) [HX5019FNL](#)
[HX5084NL](#) [3-1879385-5](#) [TX1263NLT](#) [4-1879391-0](#) [100213](#) [T1142NL](#) [HX6101FNL](#) [HX5084FNL](#) [HX1148NL](#) [HX5020FNLT](#)
[HX5014FNLT](#) [T1124NL](#)