

一、Mechanical Dimensions

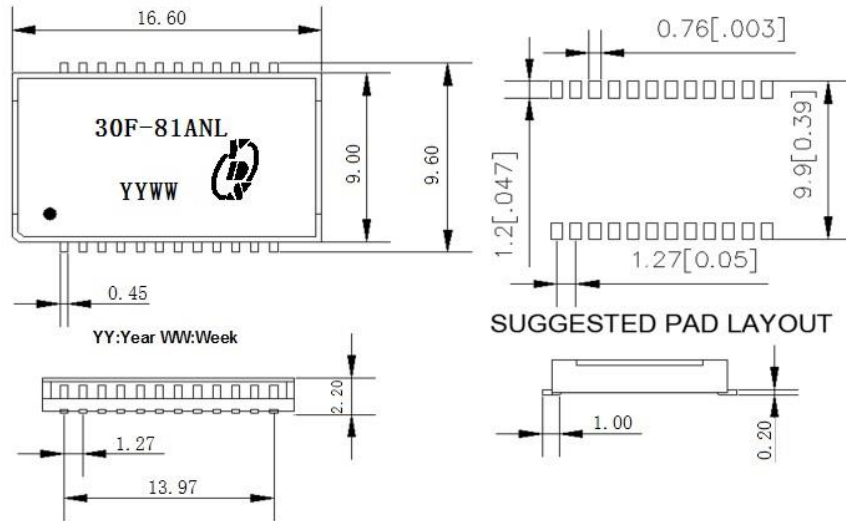

UNIT: mm Unless otherwise specified, all tolerances are ± 0.25

二、Schematics

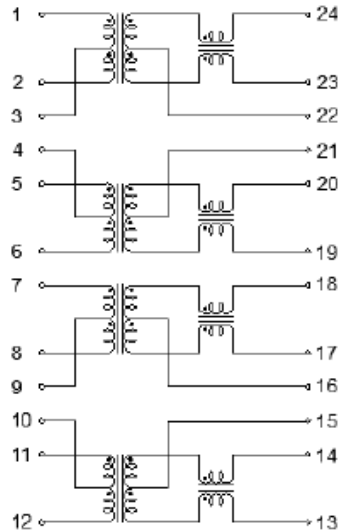

表号: TE0115A

REV.	DESCRIPTION	DATE	DWN	AP'PD
3.2	Update appearance	20.3.12	Chen	Liu
3.3	Update appearance	20.4.9	Chen	Liu
3.4	Update Spec	21.4.15	Xiao	Liu
3.5	Update Spec	21.7.9	Xiao	Liu

三、ELECTRICAL SPECIFICATIONS@25°C:

1. Turn Ratio ($\pm 3\%$): 1CT:1CT
2. OCL (100KHz/0.1V): 350uH MIN
3. Leakage Inductance (100KHz/0.1V): 0.5uH MAX
4. CW/W(100KHz/0.1V): 28pF MAX
5. DCR: 1.2 Ω MAX
6. Insertion Loss(dB MAX): -1.1dB(1-100MHz)
7. Return Loss (dB MIN): -18dB (1-30MHz), -14.4dB(40MHz), -13.1dB(50MHz), -12dB(60-100MHz)
8. Cross talk(dB MIN): -35dB(30MHz), -32dB(60-100MHz)
9. DCMR (dB MIN): -40dB(30MHz), -35dB(60MHz), -30dB(100MHz)
10. HI-POT: 1500Vrms/1mA/2Sec
11. Operating Temperature: 0°C TO +70°C
12. RoHS compliance: YES

Ref: G24P10S

	 元册科技股份有限公司 YUAN DEAN SCIENTIFIC CO., LTD.			
	TITLE	100/1000BASE-T FILTER		
	P/N	30F-81ANL	REV.	3.5
	PAGE NO	1-3	DATE	2021-7-9
	AP'PD	Liu ZhiJun	DWN	Xiao zhan

四、RoHS compliant type

Our RoHS parts just can withstand IR Reflow peak temperature: 240degC MAX as the following profile:

REV.	DESCRIPTION	DATE	DWN	AP'PD

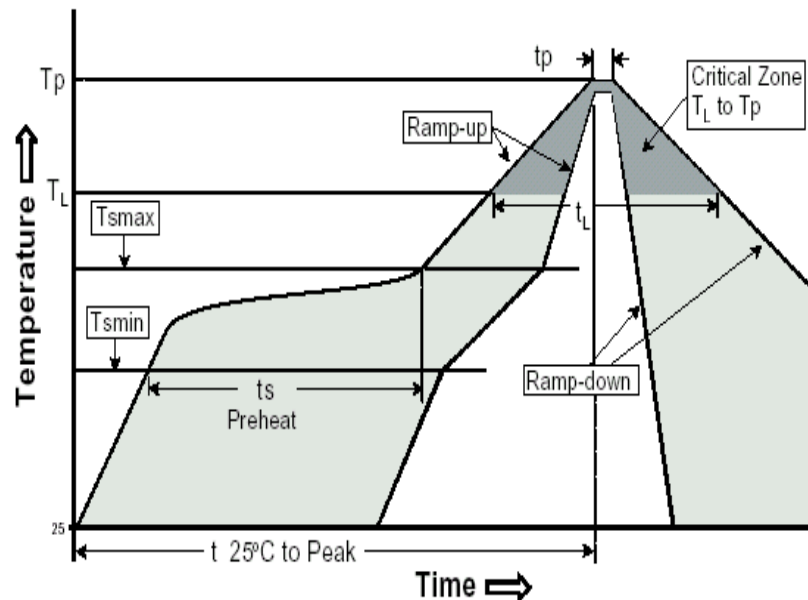

Profile Feature	Pb-Free Assembly
Average Ramp-Up Rate ($T_{s_{max}}$ to T_p)	3°C /second max.
Preheat -Temperature Min ($T_{s_{min}}$) -Temperature Max ($T_{s_{max}}$) -Time ($t_{s_{min}}$ to $t_{s_{max}}$)	150°C 200°C 60-120 seconds
Time maintained above: -Temperature (T_L) -Time (t_L)	217°C 60-150 seconds
Peak/Classification Temperature (T_p)	240°C MAX
Time within 5°C of actual Peak Temperature (t_p)	20-40 seconds
Ramp-Down Rate	6°C/seconds max
Time 25°C to Peak Temperature	6minutes max.



元册科技股份有限公司

YUAN DEAN SCIENTIFIC CO., LTD.

TITLE

100/1000BASE-T FILTER

P/N

30F-81ANL

REV.

3.5

PAGE NO

2-3

DATE

2021-7-9

AP'PD

Liu ZhiJun

DWN

Xiao zhan

五、 Packing Information:

REV.	DESCRIPTION	DATE	DWN	AP'PD

- 1.Weight-----0.56grams/pcs
- 2.Tape & Reel----- 1400pcs
3. outer carton unit: 14000pcs/box
4. outer carton unit: 10T&R/box
- 5.Weight: 11.9kg per carton

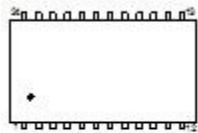

Mechanicals

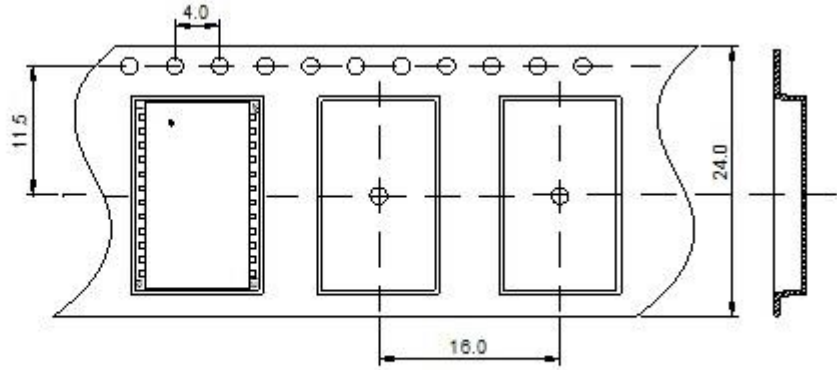

Tape & Reel

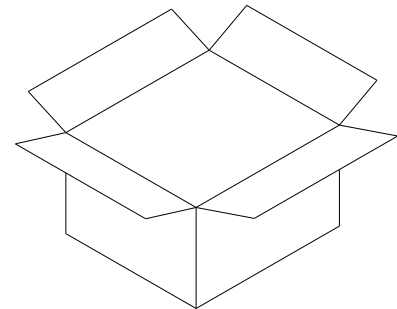
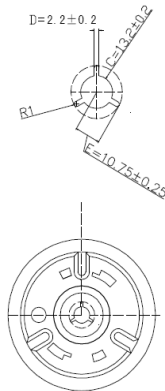
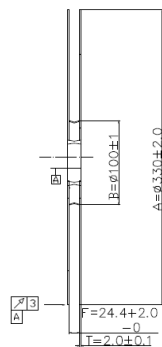
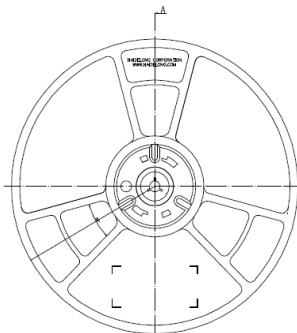

Outer carton: 365x365x350mm



元册科技股份有限公司

YUAN DEAN SCIENTIFIC CO., LTD.

TITLE

100/1000BASE-T FILTER

P/N

30F-81ANL

REV.

3.5

PAGE NO

3-3

DATE

2021-7-9

AP'PD

Liu ZhiJun

DWN

Xiao zhan

X-ON Electronics

Largest Supplier of Electrical and Electronic Components

Click to view similar products for [Audio Transformers](#) / [Signal Transformers](#) category:

Click to view products by [YDS](#) manufacturer:

Other Similar products are found below :

[CU4S0506AT-2655-H1](#) [CX2041NLT](#) [MGPWT-00449-P](#) [PE-64961](#) [H5020FNLT](#) [H5077NLT](#) [1812WBT2-4](#) [1879479-1](#) [PA1528ANL](#)
[T1137NLT](#) [T3012NL](#) [PE-65812FNL](#) [PE-65848FNLT](#) [H5019EFNL](#) [CX2045ALNLT](#) [MET-14](#) [MGPWT-00059-P](#) [MGPWT-00266-P](#)
[MGPWT-00278-P](#) [MGPWT-00431-P](#) [TTC-100](#) [TTC-143-H](#) [TTC-5032-1](#) [4-1879391-0](#) [100213](#) [T1142NL](#) [HX5020FNLT](#) [HX5014FNLT](#)
[T1124NL](#) [1879732-1](#) [2-1879391-5](#) [B8846NL](#) [MABA-010321-CT1A42](#) [TX1341NL](#) [H0013FNL](#) [H5020FNL](#) [H2009FNLT](#) [H5004NLT](#) [X-](#)
[1619](#) [T5008NLT](#) [PE-68517T](#) [MGPWT-00339-P](#) [HX5084FNLT](#) [H5014FNLT](#) [TX1473NLT](#) [PE-69011NLT](#) [CX2043LNLT](#) [H7137FNLT](#)
[H1259NLT](#) [LM-LP-1005L](#)