

# 一、外观尺寸图

表号: TE0115A

REV.	DESCRIPTION	DATE	DWN	AP'PD
2.0	Correct Housing	16.1.8	Huang	Hsu
3.0	Add Weight	16.4.7	Huang	Hsu
4.0	Add Weight	18.3.23	Zhou	Hsu
5.0	Update format	18.11.13	Zhou	Hsu

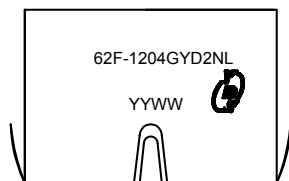

YY:Year WW:Week

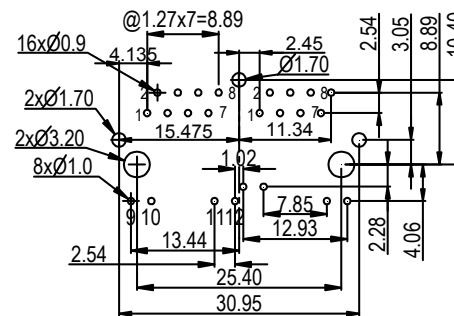
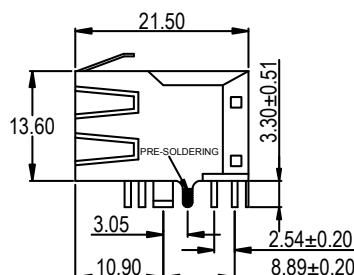
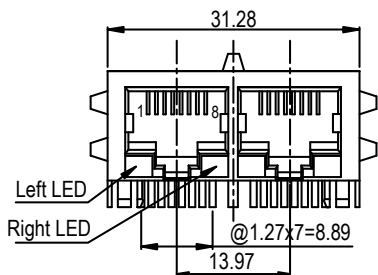

PC Board Layout  
Component Side Shown

Unit: mm Unless otherwise specified, all tolerances are ±0.25



元册科技股份有限公司

YUAN DEAN SCIENTIFIC CO., LTD.

TITLE RJ45 100 Base-T 1X2 TAB-DOWN JACK WITH MAGNETIC MODULE

P/N 62F-1204GYDXNL REV. 5.0

PAGE NO 1-5 DATE 2020-2-27

AP'PD Liu zhi Jun DWN Chen Jiapei

REV.	DESCRIPTION	DATE	DWN	AP'PD

## 二、线路图

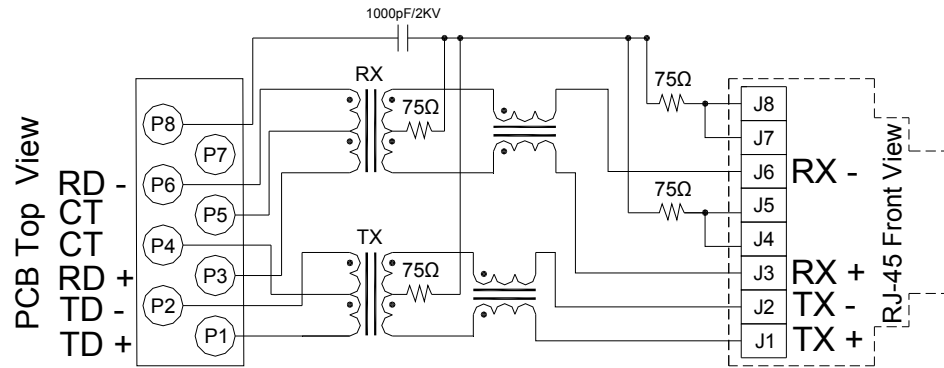

## 三、电气特性@25℃:

1. 圈比(±5%):1CT:1CT
2. 电感(100KHz/0.1V@8mA):350uH MIN
3. 插入损耗(dB TYP):-1.2dB(0.3-100MHz)
4. 反馈损耗(dB TYP): -18dB(1-10MHz),-16dB(30MHz),-12dB(60-80MHz).
5. 串音干扰(dB TYP): -40dB(1-10MHz),-35dB(30-60MHz),-30dB(60-100MHz).
6. 共模抑制(dB TYP): -30dB(1-50MHz),-20dB(50-130MHz).
7. 耐压(Pri to Sec):1500Vrms/0.5mA/60Sec or 1650Vrms/0.5mA/2Sec
8. 操作温度: 0℃ TO +70℃
9. 符合 RoHS 标准



Standard LED	Wavelength	Forward*V(MAX)	TYP
Green	565nm	2.5v	2.2v
Yellow	585nm	2.5v	2.1v

With a forward current of 20mA

### Ref: BOM-AB33



元册科技股份有限公司

YUAN DEAN SCIENTIFIC CO., LTD.

TITLE

RJ45 100 Base-T 1X2 TAB-DOWN JACK  
WITH MAGNETIC MODULE

P/N

62F-1204GYDXNL

REV.

5.0

PAGE NO

2-5

DATE

2020-2-27

AP'PD

Liu zhi Jun

DWN

Chen Jiapei

REV.	DESCRIPTION	DATE	DWN	AP'PD

#### 四、材料

##### 外壳材料:

材料: 尼龙 66 UL94V-0 标准颜色: 黑色

##### 插入材料:

材料: 磷酸青铜 C5210 EH--0.35 毫米厚度

插入-PBT GF UL94V-0

1. 电镀(1) 镍
2. 电镀(2) 100%锡
3. 电镀(3) 金(3u " ~50u " )

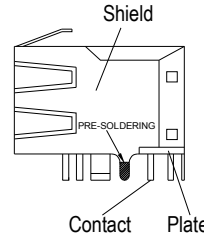
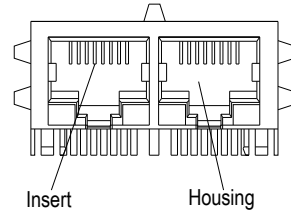

##### 板块材料:

PBT GF UL 94V-0

##### 接触脚材料:

材料: 磷酸青铜 C5191 EH--0.35 毫米厚度

1. 电镀(1) 镍
2. 电镀(2) 100%锡

##### 铁壳材料:

黄铜 C2680 镀镍

产品寿命:750 周期最小.

#### 五、环境

1. 储存温度:-40°C TO +85°C.
2. 操作温度: 0°C ~+70°C
3. 遵循于模块化插头 FCC 第 68 部分

#### 六、产品型号

**62F-1204GYDXNL**

RoHS version  
Gold Plating: 1=3u", 2=6u", 3=15u", 4=30u", 5=50u",

#### 七、产品型号

1. 包装单位: 30 个/盘
2. 包装材质: PET
3. 重量: 8.9g/pcs

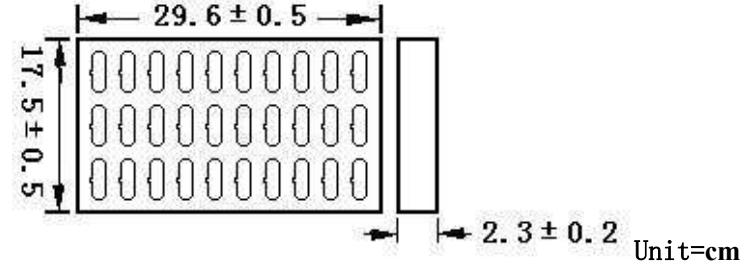

4. 外箱单位: 600 pcs/ 20 盘/箱
5. 重量: 9.0kg per carton

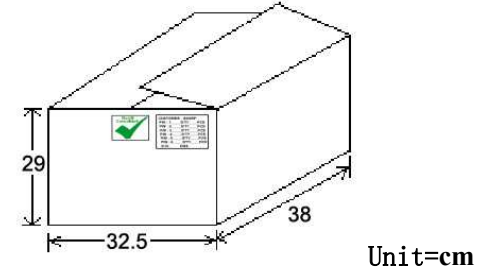

	<b>元册科技股份有限公司</b> YUAN DEAN SCIENTIFIC CO., LTD.			
	TITLE		RJ45 100 Base-T 1X2 TAB-DOWN JACK WITH MAGNETIC MODULE	
	P/N	62F-1204GYDXNL	REV.	5.0
	PAGE NO	3-5	DATE	2020-2-27
	AP'PD	Liu zhi Jun	DWN	Chen Jiawei

# 八、RJ 插头规范

REV.	DESCRIPTION	DATE	DWN	AP'PD

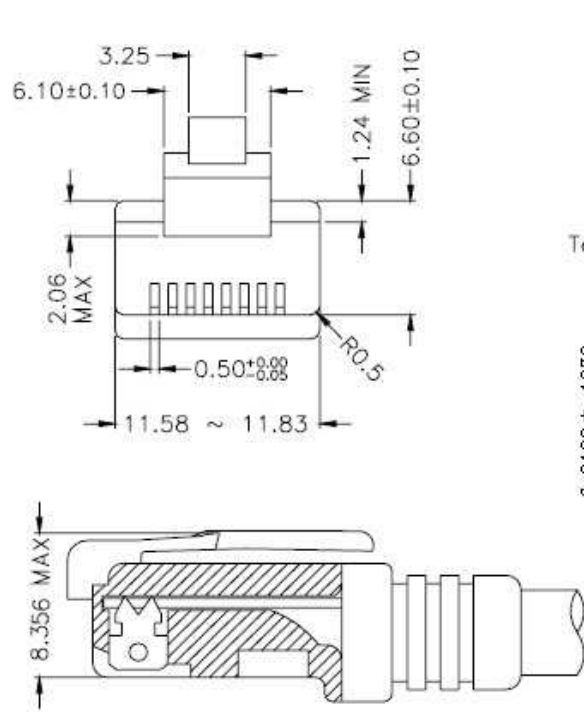

FOLLOW SPECIFICATION : FCC, PART 68, SUBPART F FIGURE 68.500 (C)(2)(ii)

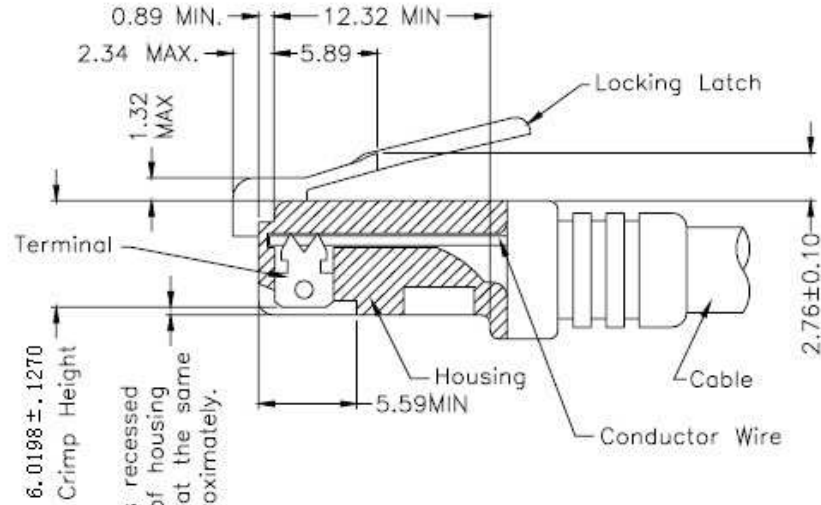

All contacts recessed below top of housing and must be at the same height approximately.

FOLLOW SPECIFICATION : FCC, PART 68, SUBPART F FIGURE 68.500 (C)(2)(i) AND IEC 603-7 FIGURE 23 & 24

STANDARD MODULAR PLUG ASSEMBLY

	<b>元册科技股份有限公司</b> YUAN DEAN SCIENTIFIC CO., LTD.			
	<b>TITLE</b>		<b>RJ45 100 Base-T 1X2 TAB-DOWN JACK WITH MAGNETIC MODULE</b>	
	<b>P/N</b>	<b>62F-1204GYDXNL</b>	<b>REV.</b>	<b>5.0</b>
	<b>PAGE NO</b>	<b>4-5</b>	<b>DATE</b>	<b>2020-2-27</b>
	<b>AP'PD</b>	<b>Liu zhi Jun</b>	<b>DWN</b>	Chen Jiapei

# 九、波峰焊建议

REV.	DESCRIPTION	DATE	DWN	AP'PD

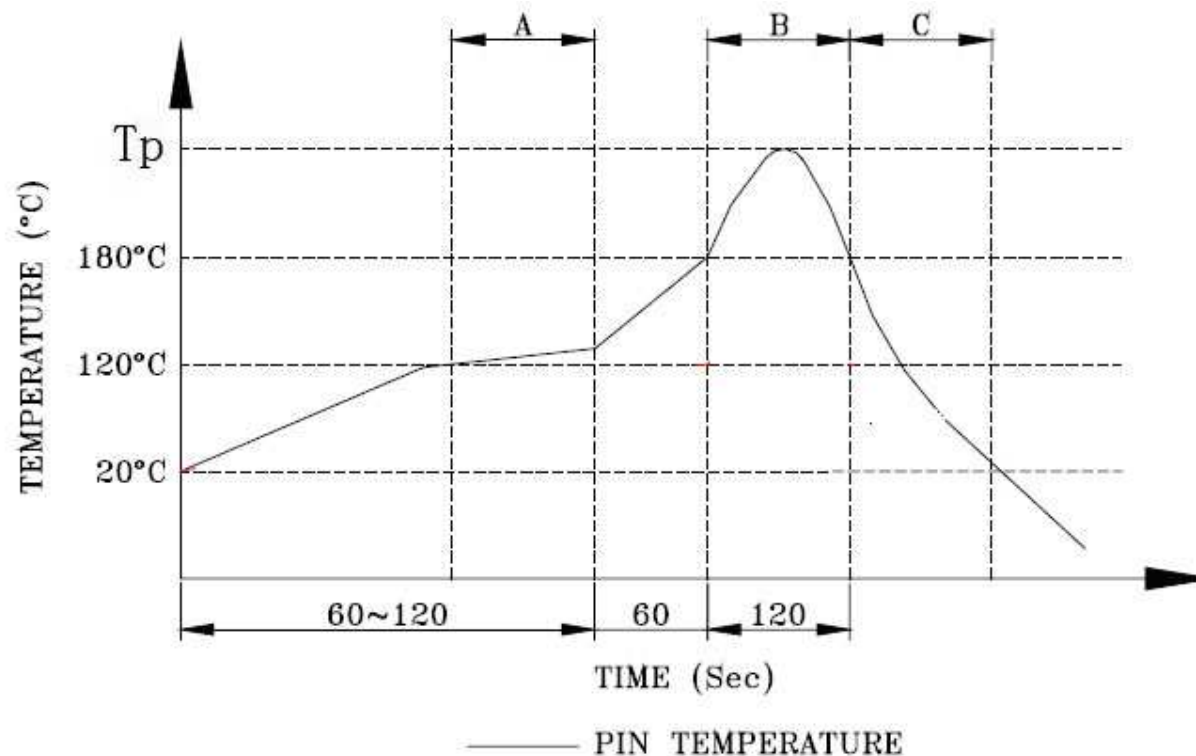

A. Preheating    B. Soldering    C. Gradual Cooling

## 建议的波峰焊曲线

1. 峰值温度 (TP):  $250 \pm 10^{\circ}\text{C}$
2. 峰值温度 (TP) 时间: 5 秒最多

 <p>RoHS Compliant</p>	 <b>元册科技股份有限公司</b> YUAN DEAN SCIENTIFIC CO., LTD.				
	TITLE		RJ45 100 Base-T 1X2 TAB-DOWN JACK WITH MAGNETIC MODULE		
	P/N		62F-1204GYDXNL	REV.	5.0
	PAGE NO		5-5	DATE	2020-2-27
	AP'PD		Liu zhi Jun	DWN	Chen Jiapei

## X-ON Electronics

Largest Supplier of Electrical and Electronic Components

*Click to view similar products for [Modular Connectors](#) / [Ethernet Connectors](#) category:*

*Click to view products by [YDS](#) manufacturer:*

Other Similar products are found below :

[RJE231881317T](#) [MP1010RX-1000](#) [MP44RX-1000](#) [GAX-3-66](#) [GAX-8-62](#) [93606-0253](#) [GD-A-44](#) [GDCX-PA-66-50](#) [GDCX-PN-64](#) [GDCX-PN-66](#) [GDCX-PN-66-50](#) [GDLX-A-66](#) [GDLX-A-88](#) [GDLX-N-66](#) [GDLX-S-88K](#) [GDTX-S-88-50](#) [GDX-PA-1010](#) [GLX-N-1010M-BLK](#) [GLX-N-44M](#) [GLX-S-88M-BLK](#) [GMX-N-1010](#) [GMX-S-1010](#) [GMX-S-66](#) [GMX-SMT2-N-1010](#) [GMX-SMT2-N-64-50](#) [GMX-SMT2-S6-88](#) [GMX-SMT4-N-88](#) [GPX-2-64](#) [GRT1-BT1-5](#) [GSGX-N-2-88](#) [GSX-NS2-88-3.05](#) [GSX-NS2-88-3.05-50](#) [GSX-NS-88-3.05-30](#) [GSX-NS-88-3.05-50](#) [GSX-NS-88-3.68](#) [1-1775629-2](#) [GWLX-S-88-GR](#) [GWLX-S9-88-YG](#) [1300500326](#) [1300500227](#) [1300530003](#) [1300570002](#) [1324640-4](#) [RJ11FTVC2G](#) [RJ11FTVC2N](#) [RJFTVX2SA1G](#) [132764-001](#) [1400000](#) [1413176](#) [1413235](#)