

Surface Mount General Purpose Silicon Rectifiers

Reverse Voltage - 50 to 1000 V

Forward Current - 1 A

FEATURES

- ◆ For surface mounted applications
- ◆ Low profile package
- ◆ Glass Passivated Chip Junction
- ◆ Ideal for automated placement
- ◆ Lead free in comply with EU RoHS 2011/65/EU directives



MECHANICAL DATA

- ◆ Case: SOD-123FL
- ◆ Terminals: Solderable per MIL-STD-750, Method 2026
- ◆ Approx. Weight: 15mg / 0.00053oz

Maximum Ratings and Electrical characteristics

Ratings at 25 °C ambient temperature unless otherwise specified.
Single phase half-wave 60 Hz, resistive or inductive load, for capacitive load current derate by 20 %.

Pinning

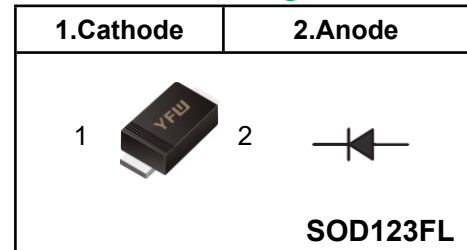

Marking Code

1N4001W	A1
1N4002W	A2
1N4003W	A3
1N4004W	A4
1N4005W	A5
1N4006W	A6
1N4007W	A7

Parameter	Symbols	1N4001W	1N4002W	1N4003W	1N4004W	1N4005W	1N4006W	1N4007W	Units
Maximum Repetitive Peak Reverse Voltage	V_{RRM}	50	100	200	400	600	800	1000	V
Maximum RMS voltage	V_{RMS}	35	70	140	280	420	560	700	V
Maximum DC Blocking Voltage	V_{DC}	50	100	200	400	600	800	1000	V
Maximum Average Forward Rectified Current at $T_c = 125\text{ }^\circ\text{C}$	$I_{F(AV)}$	1							A
Peak Forward Surge Current 8.3 ms Single Half Sine Wave Superimposed on Rated Load	I_{FSM}	30							A
Maximum Instantaneous Forward Voltage at 1 A	V_F	1.1							V
Maximum DC Reverse Current $T_a = 25\text{ }^\circ\text{C}$ at Rated DC Blocking Voltage $T_a = 125\text{ }^\circ\text{C}$	I_R	5 50							μA
Typical Junction Capacitance ⁽¹⁾	C_j	11							pF
Typical Thermal Resistance ⁽²⁾	$R_{\theta JA}$	90							$^\circ\text{C/W}$
Operating and Storage Temperature Range	T_j, T_{stg}	-55 ~ +150							$^\circ\text{C}$

(1) Measured at 1 MHz and applied reverse voltage of 4 V D.C

(2) P.C.B. mounted with 2.0" X 2.0" (5 X 5 cm) copper pad areas.

Fig.1 Forward Current Derating Curve

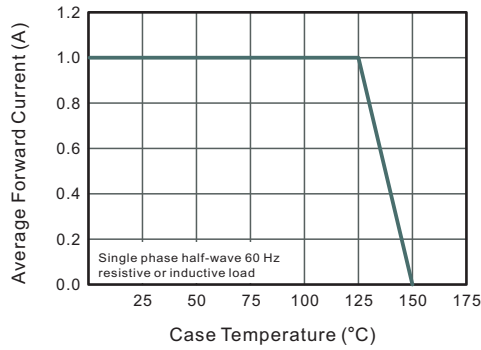

Fig.2 Typical Instantaneous Reverse Characteristics

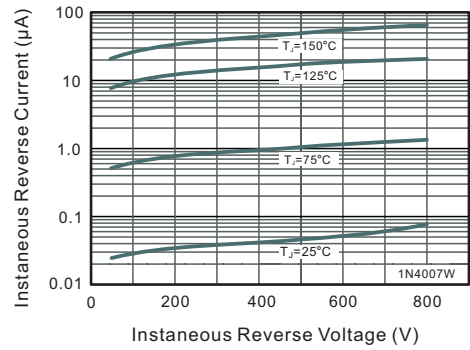

Fig.3 Typical Forward Characteristic

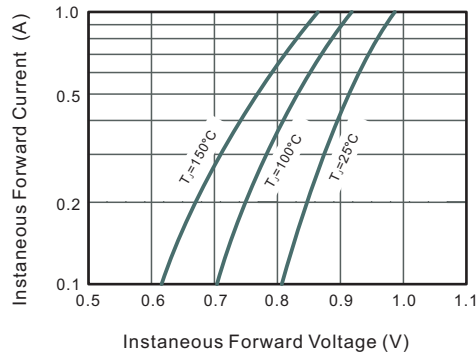

Fig.4 Typical Junction Capacitance

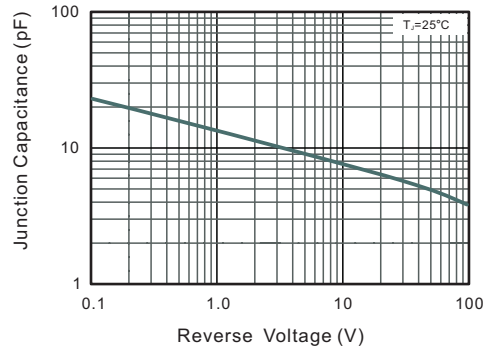
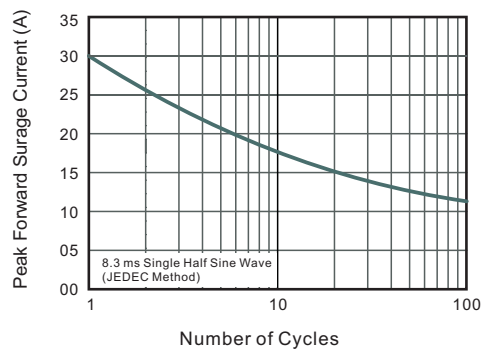
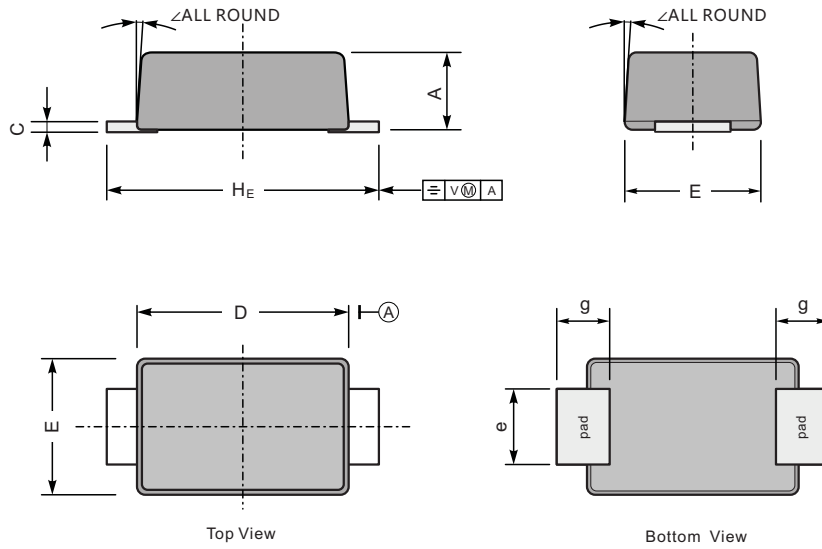

Fig.5 Maximum Non-Repetitive Peak Forward Surge Current



Package Outline SOD-123FL

Plastic surface mounted package; 2 leads



UNIT		A	C	D	E	e	g	H _E	\angle
mm	max	1.3	0.20	2.9	1.9	1.1	0.9	3.8	7°
	min	0.9	0.12	2.6	1.7	0.8	0.7	3.5	
mil	max	43	7.9	114	75	43	35	150	
	min	35	4.7	102	67	31	28	138	

The recommended mounting pad size

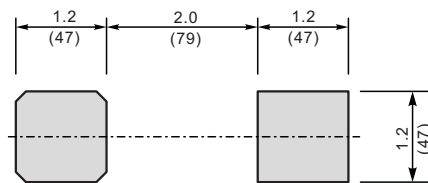

Unit: $\frac{\text{mm}}{\text{(mil)}}$

Summary of Packing Options

Package	Packing Description	Packing Quantity	Industry Standard
SOD-123FL	Tape/Reel, 13" reel	10000	EIA-481-1
	Tape/Reel, 7" reel	3000	EIA-481-1

X-ON Electronics

Largest Supplier of Electrical and Electronic Components

Click to view similar products for [Diodes - General Purpose, Power, Switching category:](#)

Click to view products by [YFW Electronics manufacturer:](#)

Other Similar products are found below :

[MCL4151-TR3](#) [MMBD3004S-13-F](#) [RD0306T-H](#) [BAV17-TR](#) [BAV19-TR](#) [1N3611](#) [NTE156A](#) [NTE574](#) [NTE6244](#) [1SS181-TP](#)
[1SS400CST2RA](#) [SDAA13](#) [SHN2D02FUTW1T1G](#) [LS4151GS08](#) [1N4449](#) [1N456A](#) [1N4934-E3/73](#) [1N914B](#) [1N914BTR](#) [1SS226-TP](#)
[RFUH20TB3S](#) [D291S45T](#) [BAV300-TR](#) [BAW56DWQ-7-F](#) [BAW75-TAP](#) [MM230L-CAA](#) [IDW40E65D1](#) [JAN1N3600](#) [JAN1N4153-1](#)
[JAN1N4454-1](#) [JAN1N4454UR-1](#) [LL4151-GS18](#) [053684A](#) [SMMSD4148T3G](#) [707803H](#) [NSVDAN222T1G](#) [CDSZC01100-HF](#) [LL4150-M-08](#)
[1N4454-TR](#) [BAV199E6433HTMA1](#) [BAV70HDW-7](#) [BAS28-7](#) [JANTX1N6640](#) [BAW56HDW-13](#) [BAS28 TR](#) [VS-HFA04SD60STR-M3](#)
[NSVM1MA152WKT1G](#) [1SS388-TP](#) [RGP30D-E3/73](#) [VS-8EWF02S-M3](#)