

■ NPN Transistors

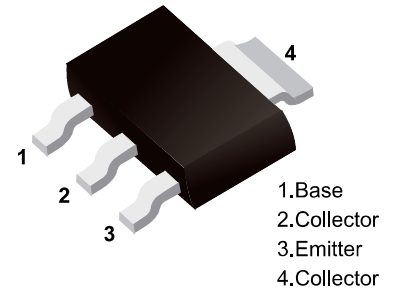

■ Simplified outline(SOT-223)

■ Features

- For AF driver and output stages
- High collector current
- Low collector-emitter saturation voltage
- Complementary to BCP51,BCP52,BCP53

■ Absolute Maximum Ratings Ta = 25°C

Parameter	Symbol	BCP54	BCP55	BCP56	Unit
Collector - Base Voltage	V _{CBO}	45	60	100	V
Collector - Emitter Voltage	V _{CEO}	45	60	80	
Emitter - Base Voltage	V _{EBO}	5			
Collector Current - Continuous	I _c	1			A
Collector Power Dissipation	P _c	1.5			W
Thermal Resistance Junction to Ambient	R _{θJA}	83.3			°C/W
Junction Temperature	T _J	150			°C
Storage Temperature Range	T _{stg}	-65 to 150			

■ Electrical Characteristics Ta = 25°C

Parameter	Symbol	Test Conditions	Min	Typ	Max	Unit	
Collector- base breakdown voltage	BCP54	$I_c = 100 \mu A, I_E = 0$	45			V	
	BCP55		60				
	BCP56		100				
Collector- emitter breakdown voltage	BCP54	$I_c = 10 mA, I_B = 0$	45			V	
	BCP55		60				
	BCP56		80				
Emitter - base breakdown voltage	V_{EBO}	$I_E = 100 \mu A, I_C = 0$	5				
Collector-base cut-off current	BCP54	I_{CBO}	$V_{CB} = 45 V, I_E = 0$			0.1	uA
	BCP55		$V_{CB} = 60 V, I_E = 0$				
	BCP56		$V_{CB} = 100 V, I_E = 0$				
Emitter cut-off current	I_{EBO}	$V_{EB} = 5 V, I_C = 0$			0.1		
Collector-emitter saturation voltage	$V_{CE(sat)}$	$I_c = 500 mA, I_B = 50 mA$			0.5	V	
Base - emitter saturation voltage	$V_{BE(sat)}$	$I_c = 500 mA, I_B = 50 mA$			1.2		
Base-emitter voltage	V_{BE}	$V_{CE} = 2 V, I_c = 500 mA$			1		
DC current gain	$h_{FE(1)}$	$V_{CE} = 2 V, I_c = 5 mA$	25				
	$h_{FE(2)}$	$V_{CE} = 2 V, I_c = 150 mA$	63		250		
	$h_{FE(3)}$	$V_{CE} = 2 V, I_c = 500 mA$	25				
Transition frequency	f_T	$V_{CE} = 10 V, I_c = 50 mA, f = 100 MHz$	100			MHz	

CLASSIFICATION OF $h_{FE(2)}$

Rank	BCP54-10, BCP55-10, BCP56-10	BCP54-16, BCP55-16, BCP56-16
Range	63-160	100-250
Marking	BCP54-10, BCP55-10, BCP56-10	BCP54-16, BCP55-16, BCP56-16

■ Typical Characteristics

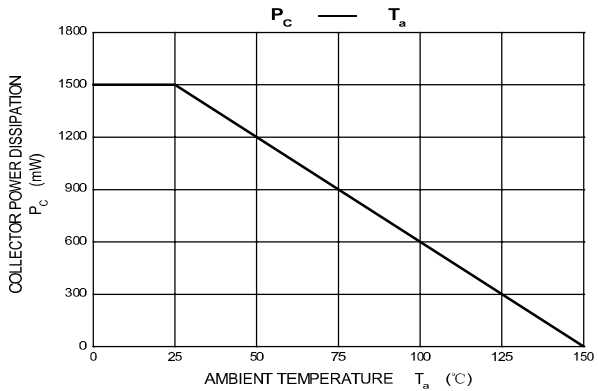
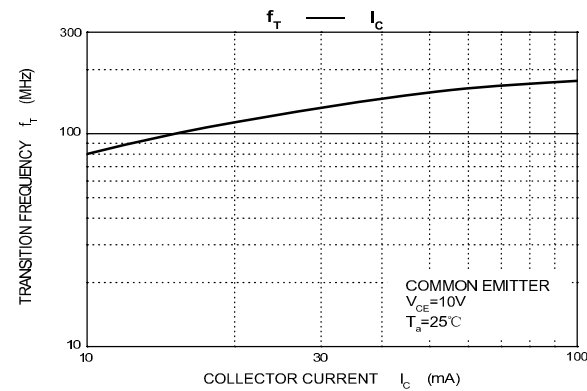
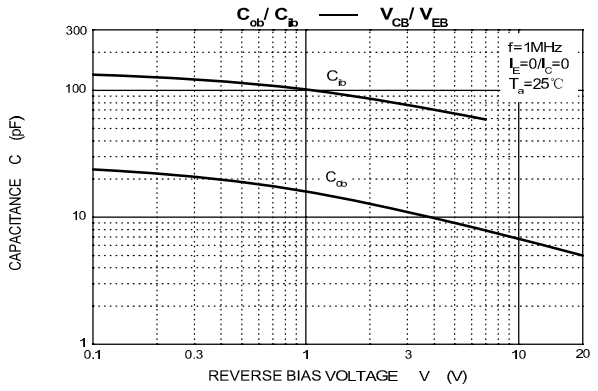
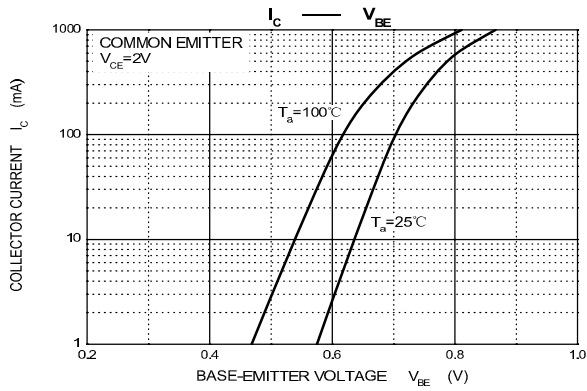
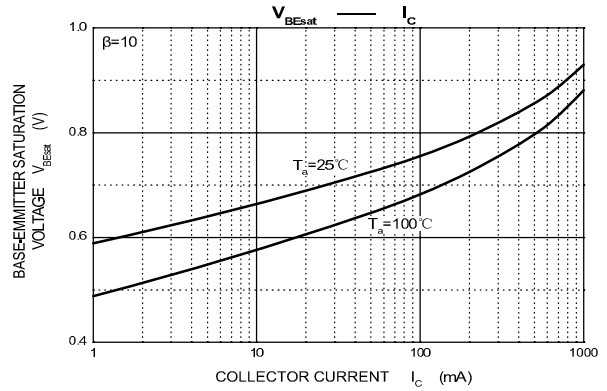
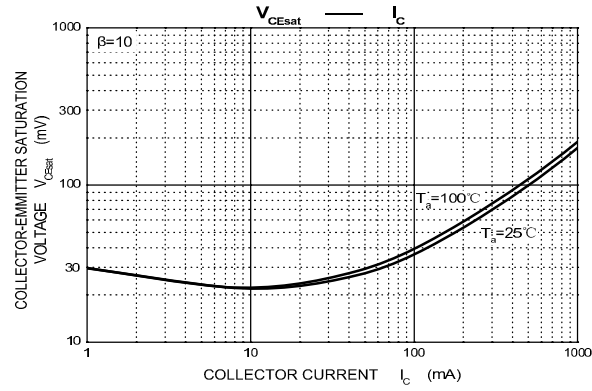
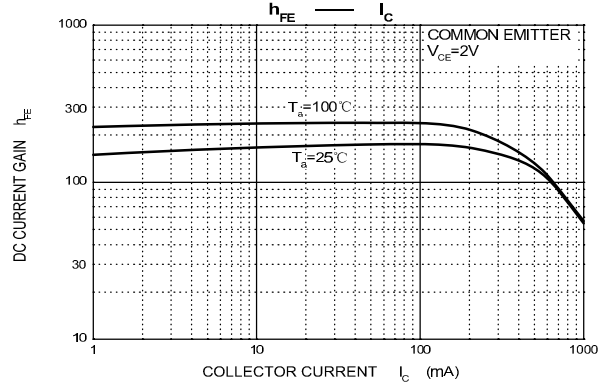
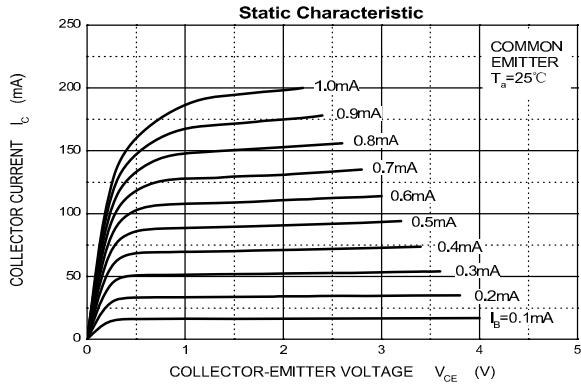

Package Outline

SOT-223

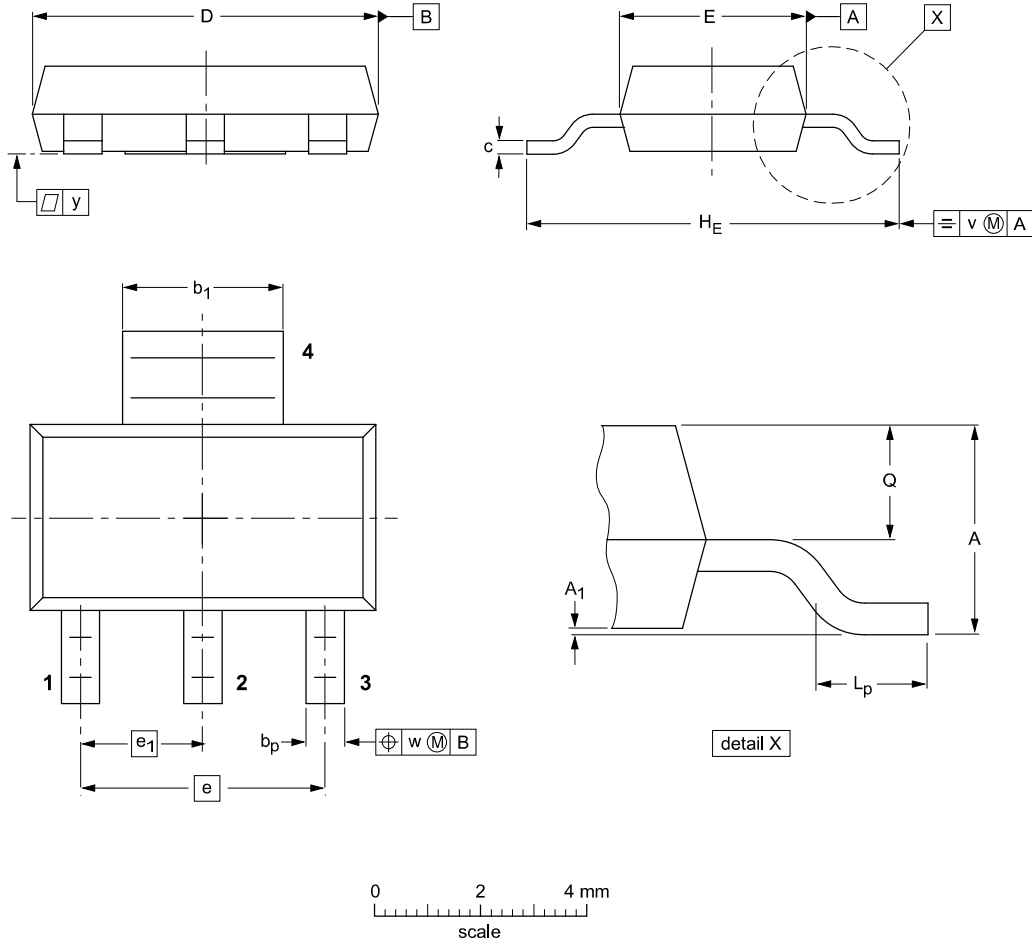

DIMENSIONS (mm are the original dimensions)

UNIT	A	A ₁	b _p	b ₁	c	D	E	e	e ₁	H _E	L _p	Q	v	w	y
mm	1.8 1.5	0.10 0.01	0.80 0.60	3.1 2.9	0.32 0.22	6.7 6.3	3.7 3.3	4.6	2.3	7.3 6.7	1.1 0.7	0.95 0.85	0.2	0.1	0.1

X-ON Electronics

Largest Supplier of Electrical and Electronic Components

Click to view similar products for [Bipolar Transistors - BJT category](#):

Click to view products by [YFW Electronics manufacturer](#):

Other Similar products are found below :

[BC559C](#) [MCH4017-TL-H](#) [MMBT-2369-TR](#) [BC546/116](#) [NJVMJD148T4G](#) [NTE16](#) [NTE195A](#) [IMX9T110](#) [2N4401-A](#) [2N6728](#) [2SA1419T-TD-H](#) [2SB1204S-TL-E](#) [2SC5488A-TL-H](#) [FMC5AT148](#) [2N2369ADCSM](#) [2N2907A](#) [2N3904-NS](#) [2N5769](#) [2SC4618TLN](#) [CPH6501-TL-E](#) [US6T6TR](#) [BAX18/A52R](#) [BC556/112](#) [IMZ2AT108](#) [MMST8098T146](#) [MCH6102-TL-E](#) [BC846B-13-F](#) [2N3879](#) [30A02MH-TL-E](#) [NTE13](#) [NTE282](#) [NTE323](#) [NTE350](#) [NTE81](#) [JANTX2N2920L](#) [JANSR2N2907AUB](#) [CMLT3946EG TR](#) [SNSS40600CF8T1G](#) [CMLT3906EG TR](#) [GRP-DATA-JANS2N2907AUB](#) [GRP-DATA-JANS2N2222AUA](#) [MMDT3946FL3-7](#) [2N4240](#) [JANS2N3019](#) [MSB30KH-13](#) [2N2221AUB](#) [2SD1815T-TL-E](#) [2N6678](#) [2N2907Ae4](#) [JAN2N3507](#)