

Surface Mount Superfast Recovery Rectifier

Reverse Voltage - 50 to 600 V

Forward Current - 1 A

FEATURES

- ◆ Glass Passivated Chip Junction
- ◆ For surface mounted applications
- ◆ Low profile package
- ◆ Superfast reverse recovery time
- ◆ Lead free in comply with EU RoHS 2011/65/EU directives



MECHANICAL DATA

- ◆ Case: DO-214AC/SMA
- ◆ Terminals: Solderable per MIL-STD-750, Method 2026
- ◆ Approx. Weight: 0.07g / 0.002oz

Pinning

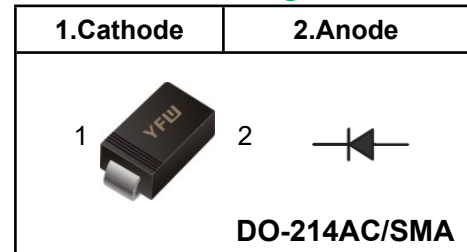

Marking Code

ES1A	ES1A
ES1B	ES1B
ES1D	ES1D
ES1G	ES1G
ES1J	ES1J

Absolute Maximum Ratings and characteristics

Ratings at 25 °C ambient temperature unless otherwise specified.

Single phase half-wave 60 Hz, resistive or inductive load, for capacitive load current derate by 20 %.

Parameter	Symbols	ES1A	ES1B	ES1D	ES1G	ES1J	Units
Maximum Repetitive Peak Reverse Voltage	V_{RRM}	50	100	200	400	600	V
Maximum RMS voltage	V_{RMS}	35	70	140	280	420	V
Maximum DC Blocking Voltage	V_{DC}	50	100	200	400	600	V
Maximum Average Forward Rectified Current at $T_c = 125\text{ }^\circ\text{C}$	$I_{F(AV)}$	1					A
Peak Forward Surge Current 8.3 ms Single Half Sine Wave Superimposed on Rated Load	I_{FSM}	30					A
Maximum Instantaneous Forward Voltage at 1 A	V_F	0.95			1.25	1.65	V
Maximum DC Reverse Current $T_a = 25\text{ }^\circ\text{C}$ at Rated DC Blocking Voltage $T_a = 125\text{ }^\circ\text{C}$	I_R	5 100					μA
Typical Junction Capacitance at $V_R=4\text{V}, f=1\text{MHz}$	C_j	15					pF
Maximum Reverse Recovery Time ⁽¹⁾	T_{rr}	35					nS
Typical Thermal Resistance ⁽²⁾	$R_{\theta JA}$	110					$^\circ\text{C/W}$
Operating and Storage Temperature Range	T_j, T_{stg}	-55 ~ +150					$^\circ\text{C}$

(1) Measured with $I_F=0.5\text{A}, I_R=1\text{A}, I_n=0.25\text{A}$

(2) P.C.B. mounted with 1.0" X 1.0" (2.54 X 2.54 cm) copper pad areas.

Fig.1 Reverse Recovery Time Characteristic And Test Circuit Diagram

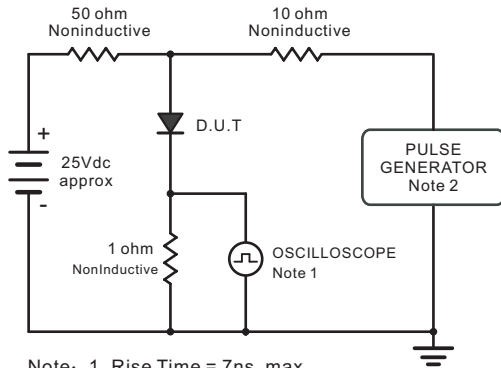

Note: 1. Rise Time = 7ns, max.
Input Impedance = 1megohm, 22pF.
2. Rise Time = 10ns, max.
Source Impedance = 50 ohms.

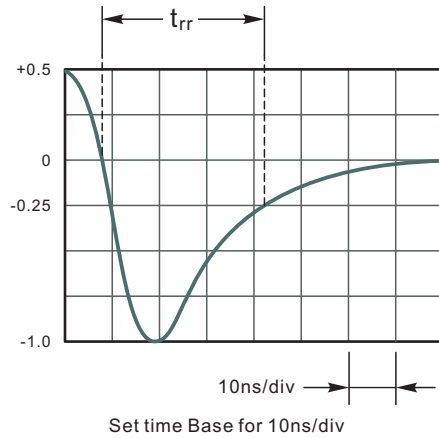

Fig.2 Maximum Average Forward Current Rating

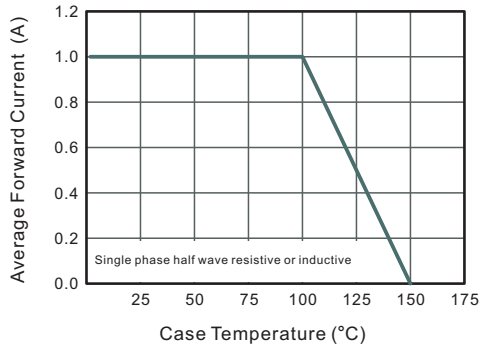

Fig.3 Typical Reverse Characteristics

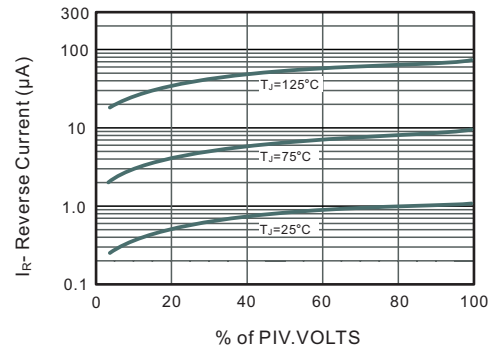

Fig.4 Typical Forward Characteristics

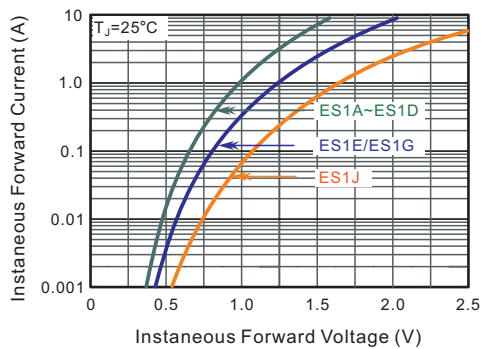

Fig.5 Typical Junction Capacitance

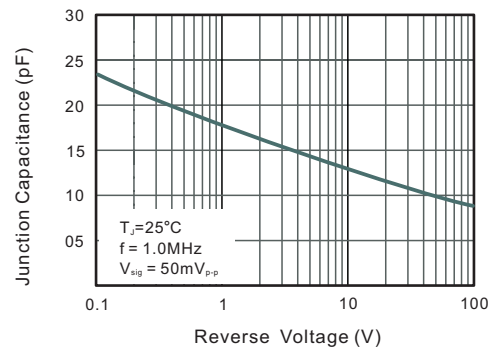
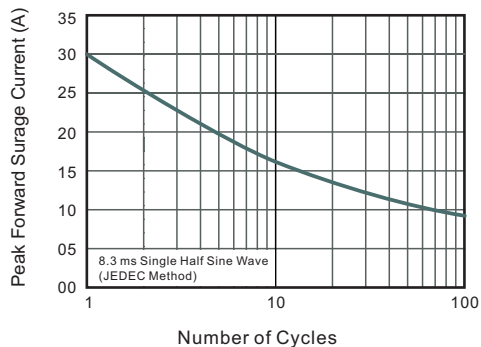
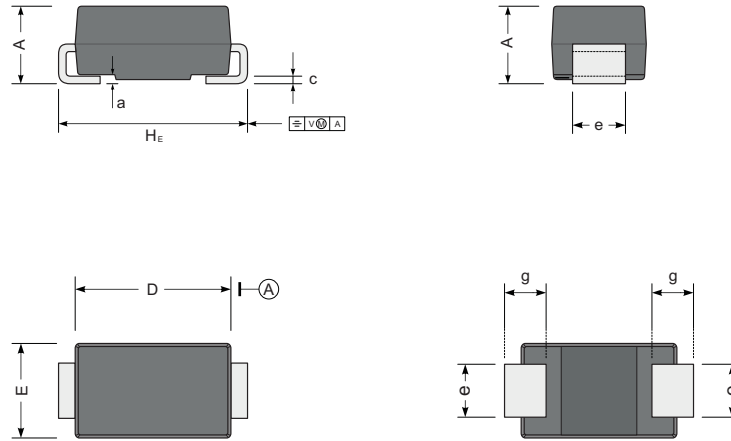

Fig.6 Maximum Non-Repetitive Peak Forward Surge Current



Package Outline DO-214AC SMA

Plastic surface mounted package; 2 leads



UNIT		A	D	E	H _E	c	e	g	a
mm	max	2.42	4.5	2.80	5.2	0.31	1.6	1.5	0.3
	min	1.98	4.0	2.54	4.7	0.15	1.3	0.9	
mil	max	96	181	110	205	12	63	59	12
	min	78	157	100	185	6	51	35	

The recommended mounting pad size

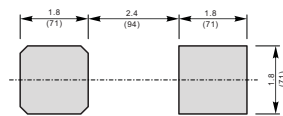

Unit : $\frac{\text{mm}}{\text{(mil)}}$

Summary of Packing Options

Package	Packing Description	Packing Quantity	Industry Standard
DO-214AC SMA	Tape/Reel, 11" reel	5000	EIA-481-1
	Tape/Reel, 7" reel	2000	EIA-481-1

X-ON Electronics

Largest Supplier of Electrical and Electronic Components

Click to view similar products for [Rectifiers](#) category:

Click to view products by [YFW Electronics](#) manufacturer:

Other Similar products are found below :

[70HFR40](#) [FR105 R0](#) [RL252-TP](#) [1N5397](#) [JANTX1N5634A](#) [1N4002G](#) [1N4005-TR](#) [JANS1N6640US](#) [481235F](#) [RRE02VS6SGTR](#) [067907F](#)
[MS306](#) [US2JFL-TP](#) [A1N5404G-G](#) [CRS12\(T5L,TEMQ\)](#) [ACGRB207-HF](#) [CLH07\(TE16L,Q\)](#) [CLH03\(TE16L,Q\)](#) [ACGRC307-HF](#)
[ACEFC304-HF](#) [DZ-1380](#) [NTE6356](#) [NTE6359](#) [JAN1N5555](#) [85HFR60](#) [40HFR60](#) [70HF120](#) [85HFR80](#) [D126A45C](#) [SCF7500](#) [SCHJ22.5K](#)
[SM100](#) [SCPA2](#) [SDHD5K](#) [ACGRA4001-HF](#) [D1821SH45T PR](#) [D1251S45T](#) [NTE6358](#) [NTE5850](#) [NTE5819](#) [NTE5837](#) [NTE5892](#) [NTE5900](#)
[NTE5911](#) [NTE5915](#) [NTE5921](#) [NTE6104](#) [NTE6105](#) [NTE6154](#) [NTE6158](#)