

**Surface Mount Superfast Recovery Rectifier**

**Reverse Voltage - 50 to 600 V**

**Forward Current - 2 A**

**FEATURES**

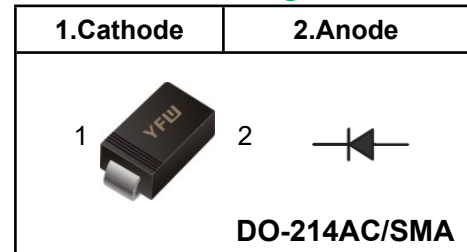
- ◆ Glass Passivated Chip Junction
- ◆ For surface mounted applications
- ◆ Low profile package
- ◆ Superfast reverse recovery time
- ◆ Lead free in comply with EU RoHS 2011/65/EU directives



**MECHANICAL DATA**

- ◆ Case: DO-214AC/SMA
- ◆ Terminals: Solderable per MIL-STD-750, Method 2026
- ◆ Approx. Weight: 0.07g / 0.002oz

**Pinning**



**Marking Code**

<b>ES2A</b>	<b>ES2A</b>
<b>ES2B</b>	<b>ES2B</b>
<b>ES2D</b>	<b>ES2D</b>
<b>ES2G</b>	<b>ES2G</b>
<b>ES2J</b>	<b>ES2J</b>

**Absolute Maximum Ratings and characteristics**

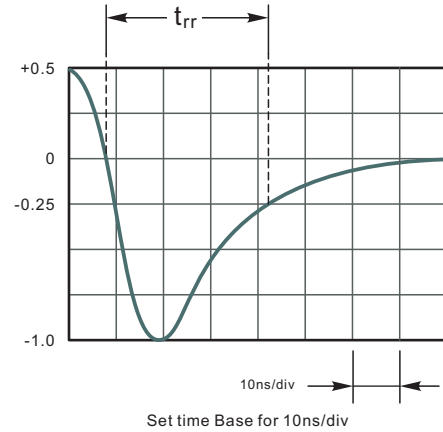
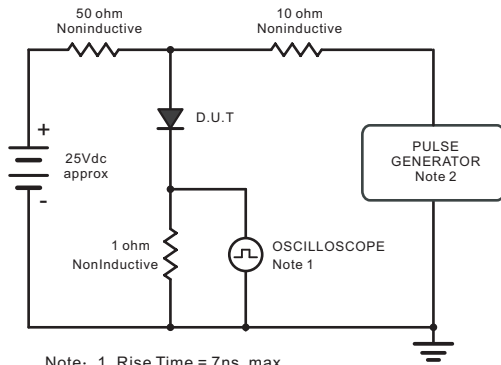
Ratings at 25 °C ambient temperature unless otherwise specified.  
Single phase half-wave 60 Hz, resistive or inductive load, for capacitive load current derate by 20 %.

Parameter	Symbols	ES2A	ES2B	ES2D	ES2G	ES2J	Units
Maximum Repetitive Peak Reverse Voltage	$V_{RRM}$	50	100	200	400	600	V
Maximum RMS voltage	$V_{RMS}$	35	70	140	280	420	V
Maximum DC Blocking Voltage	$V_{DC}$	50	100	200	400	600	V
Maximum Average Forward Rectified Current at $T_c = 125\text{ }^\circ\text{C}$	$I_{F(AV)}$	2					A
Peak Forward Surge Current 8.3 ms Single Half Sine Wave Superimposed on Rated Load	$I_{FSM}$	50					A
Maximum Instantaneous Forward Voltage at 2 A	$V_F$	0.95			1.25	1.65	V
Maximum DC Reverse Current $T_a = 25\text{ }^\circ\text{C}$ at Rated DC Blocking Voltage $T_a = 125\text{ }^\circ\text{C}$	$I_R$	5 100					$\mu\text{A}$
Typical Junction Capacitance at $V_R = 4\text{V}, f = 1\text{MHz}$	$C_j$	40					pF
Maximum Reverse Recovery Time <sup>(1)</sup>	$T_{rr}$	35					nS
Typical Thermal Resistance <sup>(2)</sup>	$R_{\theta JA}$	60					$^\circ\text{C/W}$
Operating and Storage Temperature Range	$T_j, T_{stg}$	-55 ~ +150					$^\circ\text{C}$

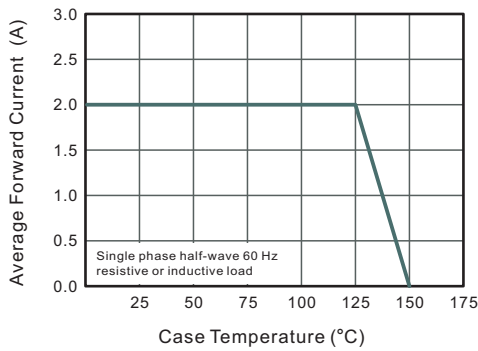
(1) Measured with  $I_F = 0.5\text{A}, I_R = 1\text{A}, I_n = 0.25\text{A}$

(2) P.C.B. mounted with 1.0" X 1.0" (2.54 X 2.54 cm) copper pad areas.

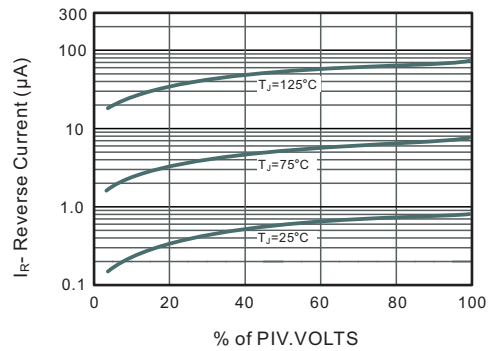
**Fig.1 Reverse Recovery Time Characteristic And Test Circuit Diagram**



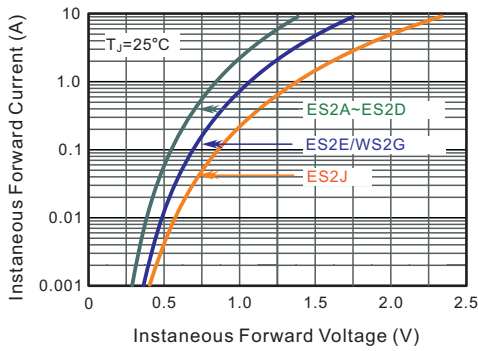
**Fig.2 Maximum Average Forward Current Rating**



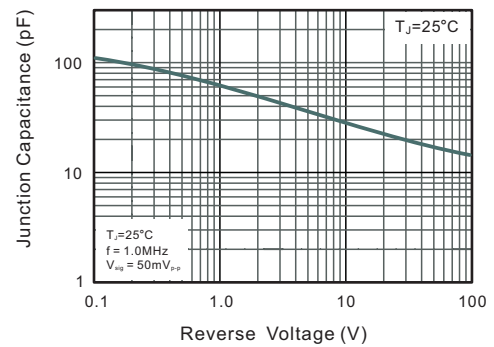
**Fig.3 Typical Reverse Characteristics**



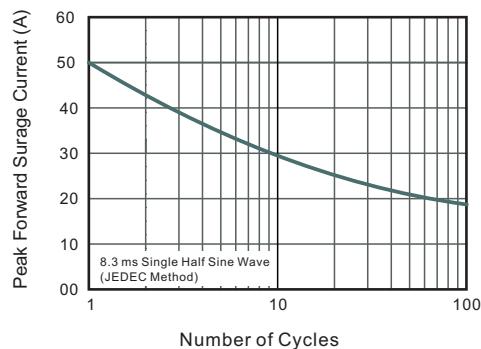
**Fig.4 Typical Forward Characteristics**



**Fig.5 Typical Junction Capacitance**

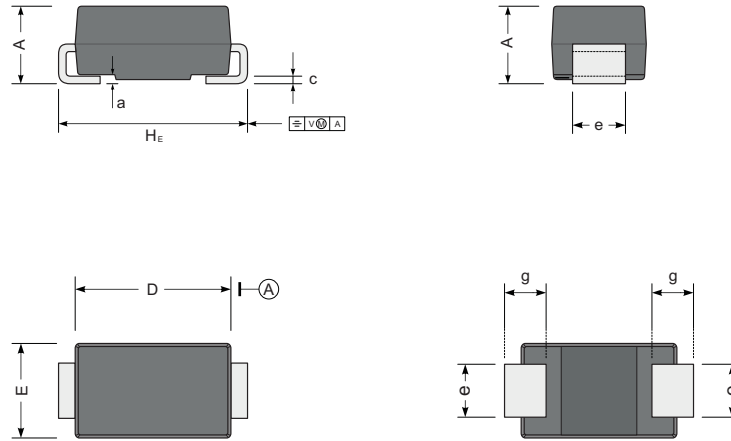


**Fig.6 Maximum Non-Repetitive Peak Forward Surge Current**



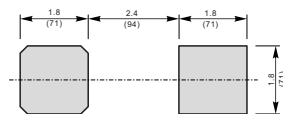
**Package Outline DO-214AC SMA**

Plastic surface mounted package; 2 leads



UNIT		A	D	E	H <sub>E</sub>	c	e	g	a
mm	max	2.42	4.5	2.80	5.2	0.31	1.6	1.5	0.3
	min	1.98	4.0	2.54	4.7	0.15	1.3	0.9	
mil	max	96	181	110	205	12	63	59	12
	min	78	157	100	185	6	51	35	

**The recommended mounting pad size**



Unit :  $\frac{\text{mm}}{\text{(mil)}}$

**Summary of Packing Options**

Package	Packing Description	Packing Quantity	Industry Standard
DO-214AC SMA	Tape/Reel, 11" reel	5000	EIA-481-1
	Tape/Reel, 7" reel	2000	EIA-481-1

## X-ON Electronics

Largest Supplier of Electrical and Electronic Components

*Click to view similar products for [Rectifiers](#) category:*

*Click to view products by [YFW Electronics](#) manufacturer:*

Other Similar products are found below :

[70HFR40](#) [FR105 R0](#) [RL252-TP](#) [1N5397](#) [JANTX1N5634A](#) [1N4002G](#) [1N4005-TR](#) [JANS1N6640US](#) [481235F](#) [RRE02VS6SGTR](#) [067907F](#)  
[MS306](#) [US2JFL-TP](#) [A1N5404G-G](#) [CRS12\(T5L,TEMQ\)](#) [ACGRB207-HF](#) [CLH07\(TE16L,Q\)](#) [CLH03\(TE16L,Q\)](#) [ACGRC307-HF](#)  
[ACEFC304-HF](#) [DZ-1380](#) [NTE6356](#) [NTE6359](#) [JAN1N5555](#) [85HFR60](#) [40HFR60](#) [70HF120](#) [85HFR80](#) [D126A45C](#) [SCF7500](#) [SCHJ22.5K](#)  
[SM100](#) [SCPA2](#) [SDHD5K](#) [ACGRA4001-HF](#) [D1821SH45T PR](#) [D1251S45T](#) [NTE6358](#) [NTE5850](#) [NTE5819](#) [NTE5837](#) [NTE5892](#) [NTE5900](#)  
[NTE5911](#) [NTE5915](#) [NTE5921](#) [NTE6104](#) [NTE6105](#) [NTE6154](#) [NTE6158](#)