

Ultra Low Capacitance ESD Protectio

Features

- ◆Peak power dissipation: 100W(8/20us)
- ◆Transient protection for high-speed data lines
- ◆IEC61000-4-2 (ESD) ±15kV(air), ±8kV(contact)
- ◆IEC61000-4-4(EFT) 40A(5/50ns)Cable Discharge Event (CDE)
- ◆Protects one data, control line
- ◆Low capacitance: 0.25pF (Typical)
- ◆Low clamping voltage
- ◆Low leakage current
- ◆Meets MSL 1 Requirements

Application

- ◆10/100M Ethernet Ports
- ◆WAN/LAN Equipment
- ◆Desktops, Servers and Notebooks
- ◆Cellular Phones
- ◆Switching Systems
- ◆Audio/Video Inputs

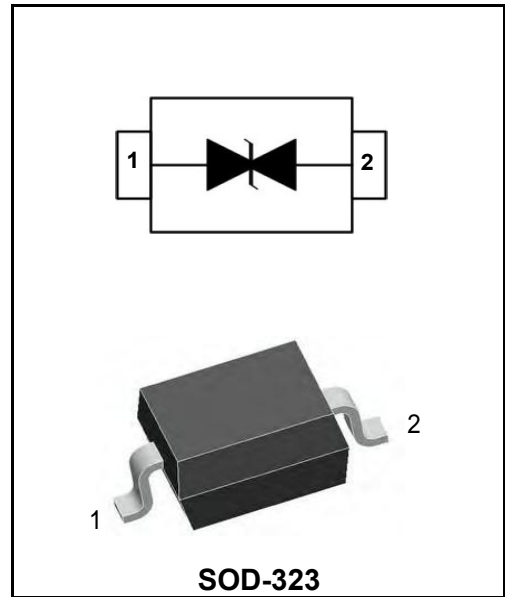

Order Information

Part Number	Package	Marking	Size (mm)	Delivery Form	Delivery Quantity
ESD3Z3.3CM	SOD-323	2M	2.6X1.3X0.5	7" T&R	3000PCS/Tape

Limiting Values(TA = 25 °C, unless otherwise specified)

Symbol	Parameter	Conditions	value	Unit
V _{ESD}	ESD per IEC 61000-4-2	Air	± 20	KV
		Contact	± 20	
P _{PP}	Peak Pulse Power	tP = 8/20 μs	100	W
T _{OPT}	Operating Temperature	-	-55 to+125	°C
T _{stg}	Storage Temperature	-	-55 to+150	°C
T _L	Lead Solder Temperature	Maximum (10 Second Duration)	260(10 sec.)	°C

Electrical Characteristics(TA = 25 °C unless otherwise specified)

Symbol	Parameter	Conditions	Min	Typ.	Max	Unit
V _{RWM}	Reverse Working Voltage		-	-	3.3	V
V _{BR}	Reverse Breakdown Voltage	I _T = 1mA	4.2	-	-	V
I _R	Reverse Leakage Current	V _{RWM} = 3.3 V	-	-	100	nA
V _C	Clamping Voltage	I _{PP} =1 A, tp = 8/20μs	-	-	12	V
V _C	Clamping Voltage	I _{PP} =4 A, tp = 8/20μs	-	-	25	V
C _J	Junction Capacitance	VR = 0V, f = 1 MHz	-	0.25	0.40	pF

Typical Characteristics

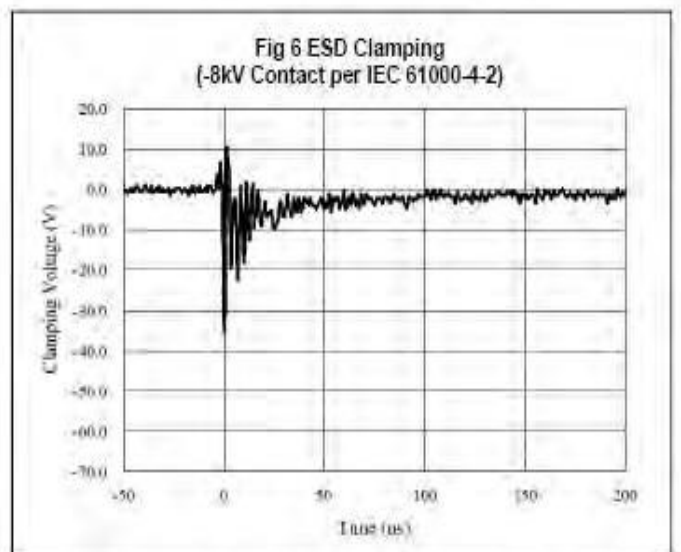
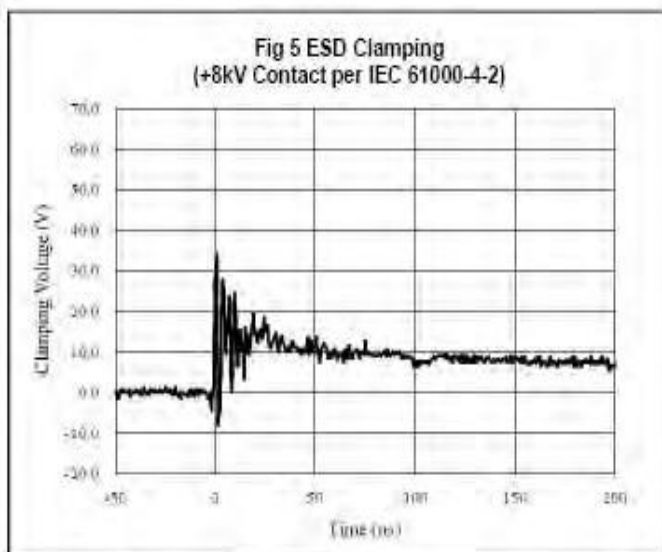
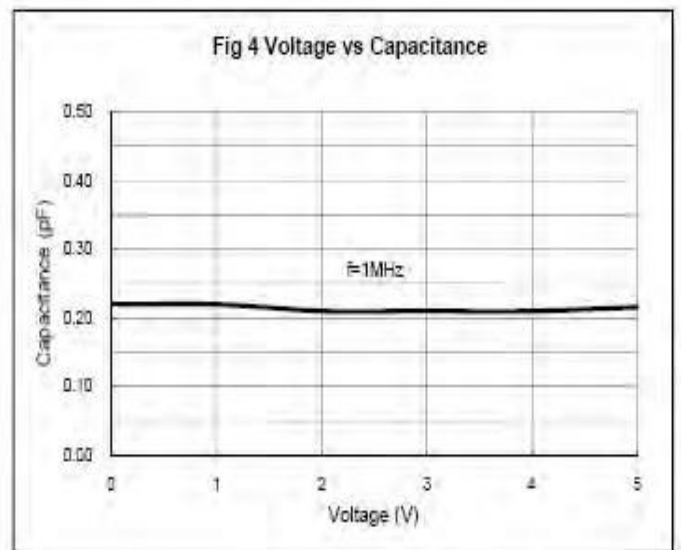
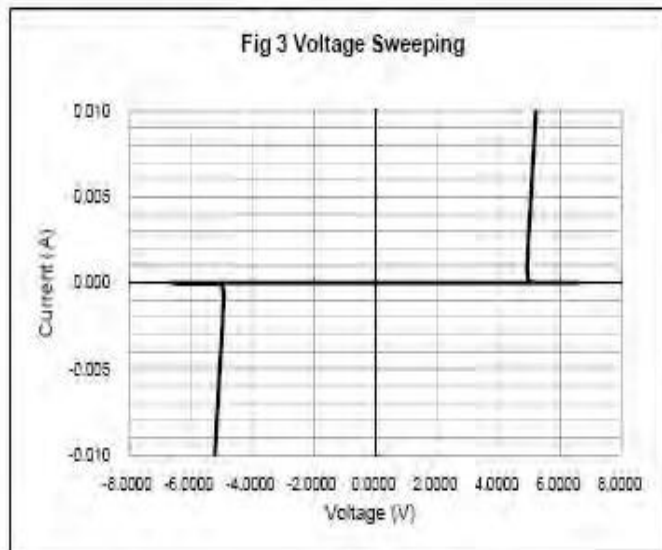
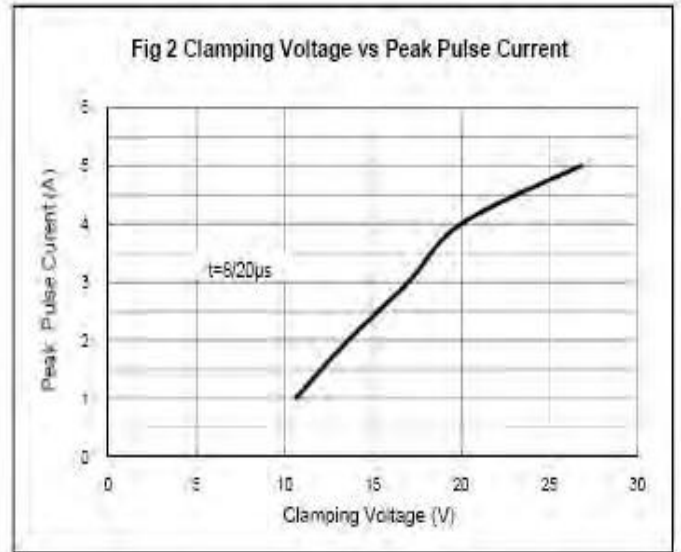
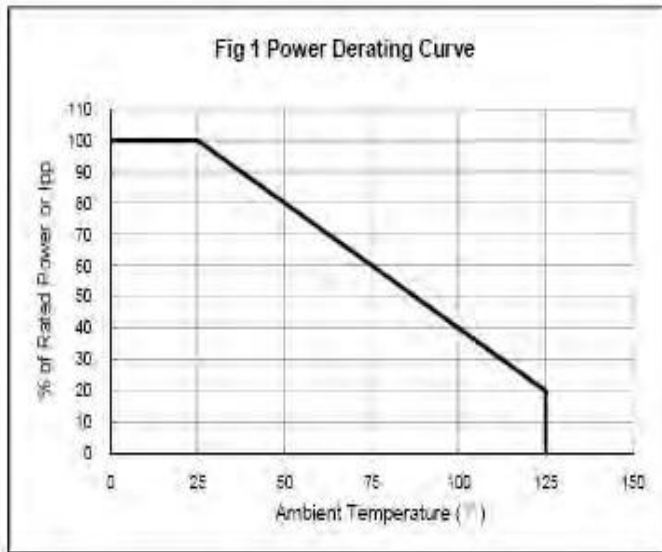

Package Outline SOD-323

Plastic surface mounted package; 2 leads

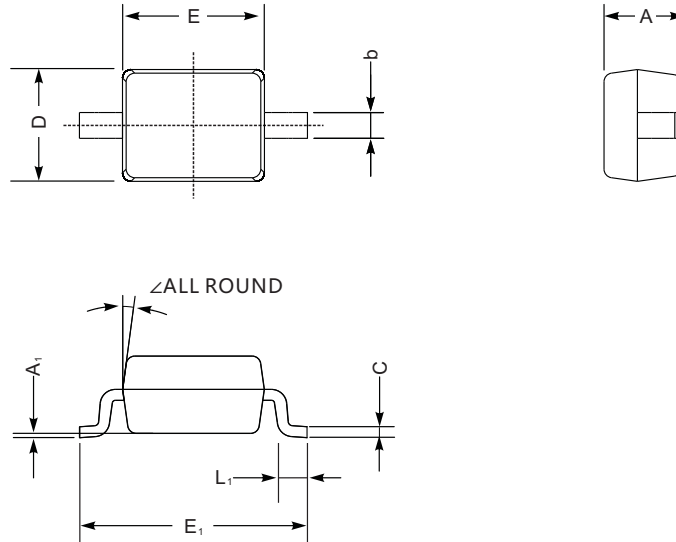

UNIT		A	C	D	E	E ₁	b	L ₁	A ₁	∠
mm	max	1.1	0.15	1.4	1.8	2.75	0.4	0.45	0.2	9°
	min	0.8	0.08	1.2	1.4	2.55	0.25	0.2	—	
mil	max	43	5.9	55	70	108	16	16	8	
	min	32	3.1	47	63	100	9.8	7.9	—	

The recommended mounting pad size

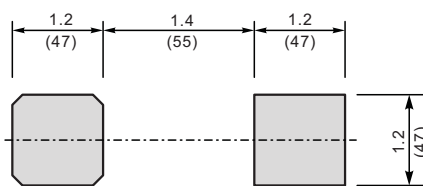

Unit: $\frac{\text{mm}}{\text{mil}}$

Summary of Packing Options

Package	Packing Description	Packing Quantity	Industry Standard
SOD-323	Tape/Reel, 7" reel	3 000	EIA-481-1

X-ON Electronics

Largest Supplier of Electrical and Electronic Components

Click to view similar products for [ESD Suppressors / TVS Diodes](#) category:

Click to view products by [YFW Electronics](#) manufacturer:

Other Similar products are found below :

[60KS200C](#) [D18V0L1B2LP-7B](#) [D5V0F4U5P5-7](#) [NTE4902](#) [P4KE27CA](#) [P6KE11CA](#) [P6KE8.2A](#) [SA60CA](#) [SA64CA](#) [SMBJ12CATR](#)
[SMBJ33CATR](#) [SMBJ6.5A](#) [SMBJ8.0A](#) [ESD101-B1-02ELS](#) [E6327](#) [ESD112-B1-02EL](#) [E6327](#) [ESD7451N2T5G](#) [19180-510](#) [CPDT-5V0USP-](#)
[HF](#) [3.0SMCJ33CA-F](#) [3.0SMCJ36A-F](#) [HSPC16701B02TP](#) [JANTX1N6126A](#) [D3V3Q1B2DLP3-7](#) [D55V0M1B2WS-7](#) [SCM1293A-04SO](#)
[ESD200-B1-CSP0201](#) [E6327](#) [SM12-7](#) [CEN955](#) [W/DATA](#) [VESD12A1A-HD1-GS08](#) [CPDQC5V0-HF](#) [D1213A-01LP4-7B](#) [ESD101-B1-02EL](#)
[E6327](#) [AOZ8808DI-03](#) [5KP15A](#) [5KP48A](#) [5KP90A](#) [ESD3V3D7-TP](#) [15KPA36A-LF](#) [P4KE56CA](#) [P4KE68A](#) [P4KE91CATR](#) [P6KE120A](#)
[P6KE13CA](#) [P6KE43CA](#) [P6KE6.8CA](#) [P6KE8.2](#) [P6SMBJ20CA](#) [JANTX1N6072A](#) [SR2835ESKG](#) [SA90CA](#)