

4.0A GLASS PASSIVATED BRIDGE RECTIFIER

Reverse Voltage - 100 to 1000 V

Forward Current – 4.0A



FEATURES

- ◆ Surge overload rating-125 amperes peak
- ◆ Polarity:As marked on body
- ◆ Ideal for printed circuit board
- ◆ Plastic material has U/L

The flammability classification 94V-0

- ◆ Reliable low cost construction utilizing molded plastic technique

MECHANICAL DATA

- ◆ Case: KBL
- ◆ Terminals: Solderable per MIL-STD-202, Method 208
- ◆ Approx. Weight: 5.6g /0.2oz

Maximum Ratings and Electrical characteristics

Ratings at 25 °C ambient temperature unless otherwise specified.

Single phase half-wave 60 Hz, resistive or inductive load, for capacitive load current derate by 20 %.

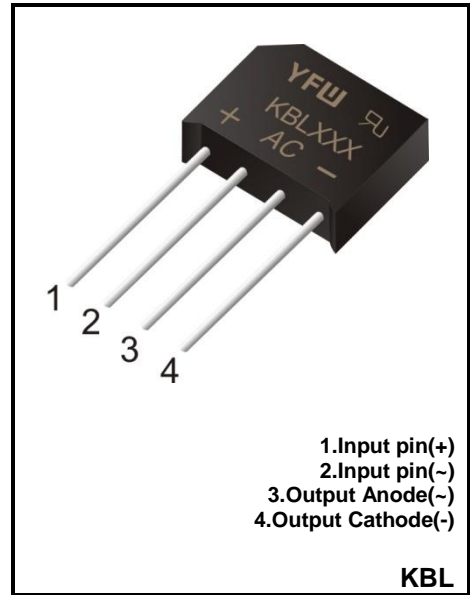

Parameter	Symbols	KBL401	KBL402	KBL404	KBL406	KBL408	KBL410	Units	
Maximum Repetitive Peak Reverse Voltage	V_{RRM}	100	200	400	600	800	1000	V	
Maximum RMS voltage	V_{RMS}	70	140	280	420	560	700	V	
Maximum DC Blocking Voltage	V_{DC}	100	200	400	600	800	1000	V	
Maximum Average Forward Rectified Current at $T_C=100^{\circ}C$ (Note 1)	$I_{(AV)}$					4.0 3.0			A
Peak Forward Surge Current 8.3 ms Single Half Sine-Wave Superimposed on Rated Load (JEDEC method)	I_{FSM}					125			A
Forward Voltage per element at 2.0A DC and 25°C	V_F					1.0			V
Maximum DC Reverse Current at Rated DC Blocking Voltage @Ta=25°C @Ta=125°C	I_R					10 500			μA
I2t Rating for Fusing(3ms≤t≤8.3ms)	I^2t					166			A ² S
Typical Junction Capacitance (Note1)	C_J					105			pF
Typical Thermal Resistance (Note2)	$R_{\theta JA}$					20			°C/W
Operating and Storage Temperature Range	T_j, T_{stg}					-55 ~ +150			°C

(1) Measured at 1 MHz and applied reverse voltage of 4 V D.C

(2) Unit case mounted on 7.5" x 7.5" x 0.3cm" Al plate heat sink.

AVERAGE FORWARD RECTIFIED CURRENT, AMPERES

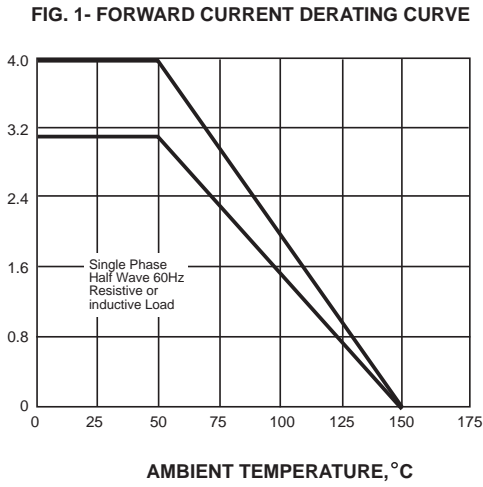

PEAK FORWARD SURGE CURRENT, AMPERES

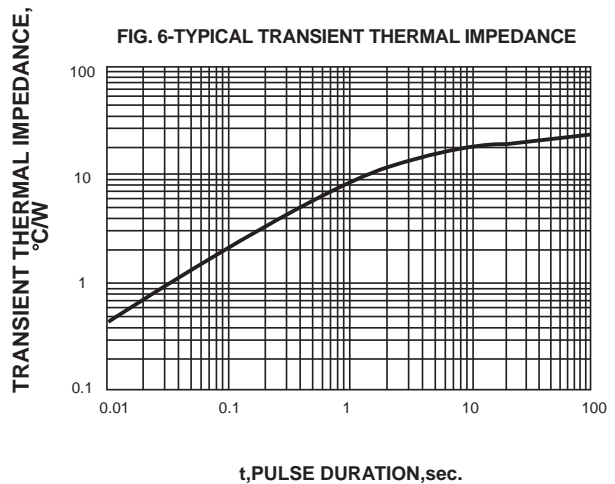
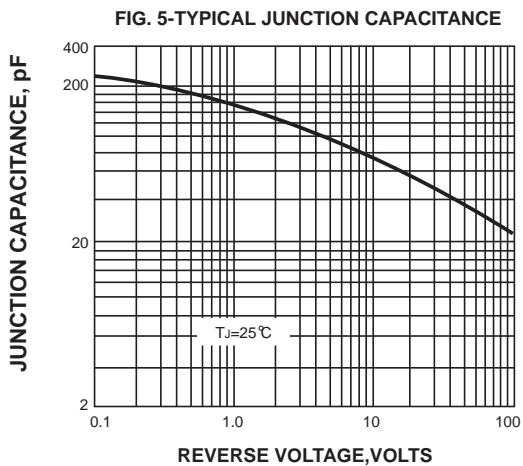
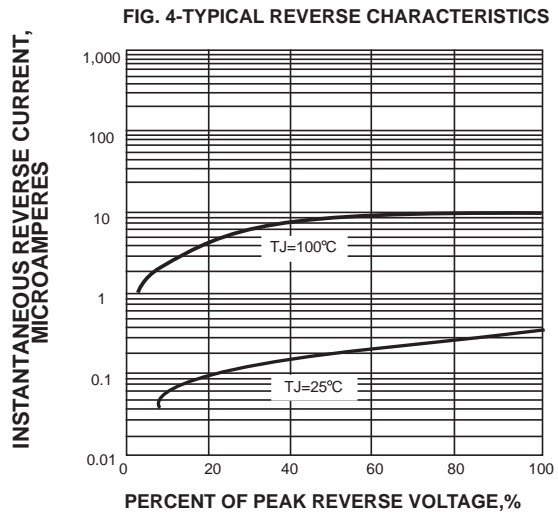
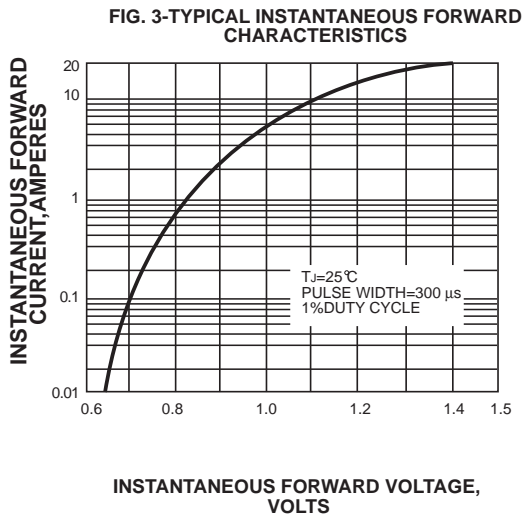
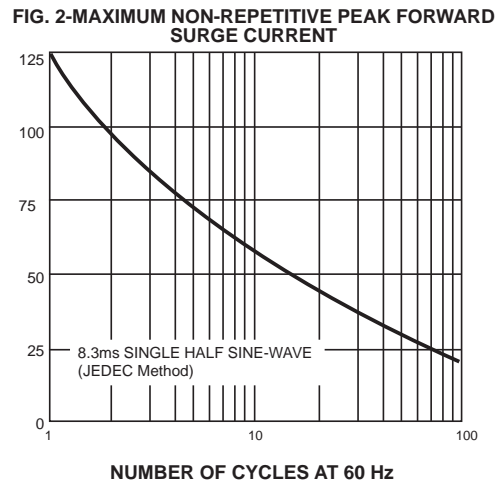

Package Outline

KBL

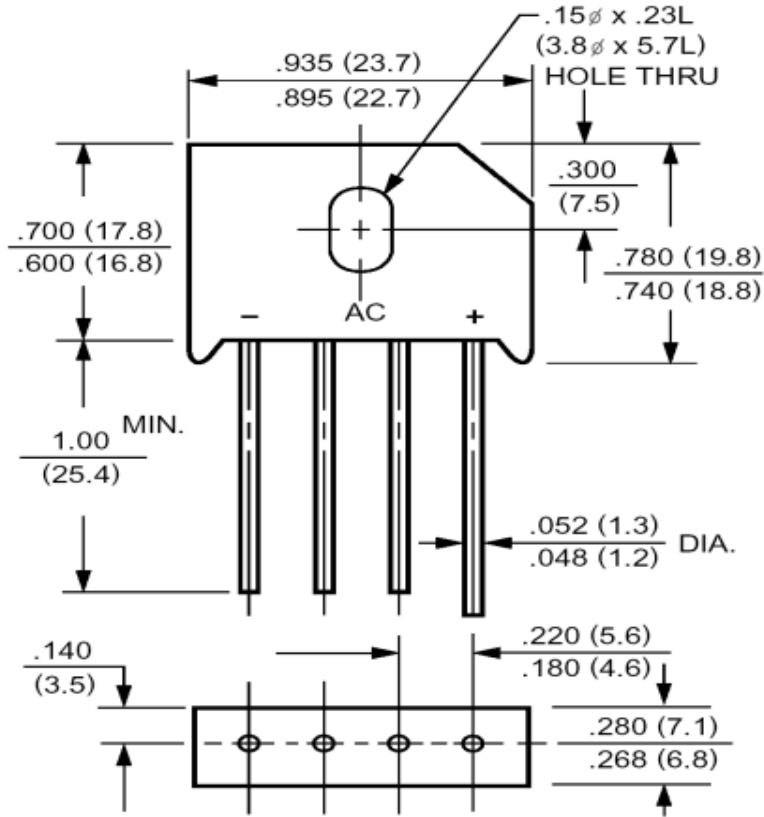

Summary of Packing Options

Package	Packing Description	Packing Quantity	Industry Standard
KBL	BOX	500	EIA-481-1

X-ON Electronics

Largest Supplier of Electrical and Electronic Components

Click to view similar products for [Bridge Rectifiers](#) category:

Click to view products by [YFW Electronics](#) manufacturer:

Other Similar products are found below :

[MB2510](#) [MB252](#) [MB356G](#) [MB358G](#) [GBJ1504-BP](#) [GBU10B-BP](#) [GBU15K-BP](#) [GBU4A-BP](#) [GBU4D-BP](#) [GBU6B-E3/45](#) [DB101-BP](#) [DF01](#)
[DF10SA-E345](#) [BU1508-E3/45](#) [BU1510-E3/45](#) [KBPC50-10S](#) [RS405GL-BP](#) [GBJ1502-BP](#) [GBU6M](#) [GSIB1520-E3/45](#) [36MB140A](#) [TB102M](#)
[MB1510](#) [MB86](#) [TL401G](#) [MDA920A2](#) [TU602](#) [TU810](#) [MP5010W-BP](#) [MP501W-BP](#) [MP502-BP](#) [BR84DTP204](#) [BU1508-E3/51](#) [KBPC25-02](#)
[VS-110MT120KPBF](#) [VS-2KBB60](#) [VS-60MT120KPBF](#) [VS-60MT80KPBF](#) [DB105-BP](#) [DF1510S](#) [VS-40MT160PAPBF](#) [VISKBU8K-E4/51](#)
[36MT100](#) [GBU4G-BP](#) [GBU6B-E3/51](#) [DF15005S-E3/77](#) [GSIB15A80-E3/45](#) [DB104-BP](#) [D3SB60](#) [TB354](#)