

**25A HIGH CURRENT SINGLE-PHASE SILICON BRIDGE RECTIFIER**

**Voltage - 600 to 1600 V**

**Forward Current – 25 A**

**FEATURES**

- ◆ High current capability
- ◆ Low forward voltage drop
- ◆ Glass Passivated Chip Junction
- ◆ Low power loss, high efficiency
- ◆ Lead free in comply with EU RoHS 2011/65/EU directives



**MECHANICAL DATA**

- ◆ Case: KBPC, KBPC-W
- ◆ Terminals: Solderable per MIL-STD-202, Method 208
- ◆ Approx. Weight: KBPC 31.6g , KBPC-W 28.5g

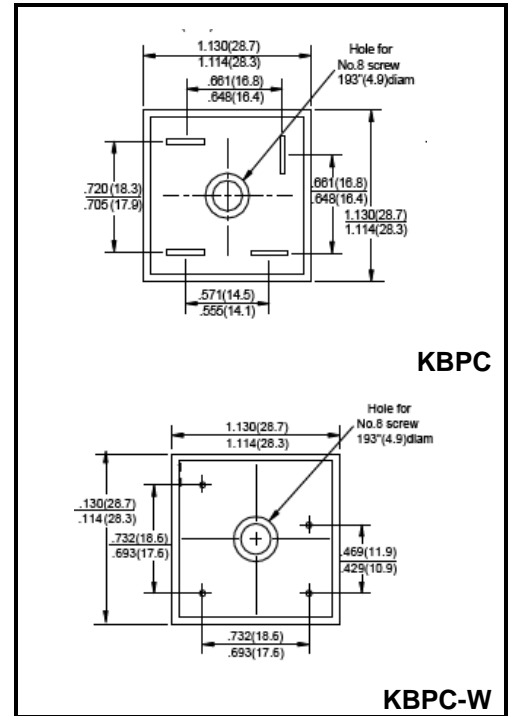

**Maximum Ratings and Electrical characteristics**

Ratings at 25 °C ambient temperature unless otherwise specified.

Parameter	Symbols	KBPC2506 (W)	KBPC2508 (W)	KBPC2510 (W)	KBPC2512 (W)	KBPC2516 (W)	Units
Maximum Repetitive Peak Reverse Voltage	$V_{RRM}$	600	800	1000	1200	1600	V
Maximum RMS voltage	$V_{RMS}$	420	560	700	840	980	V
Maximum DC Blocking Voltage	$V_{DC}$	600	800	1000	1200	1600	V
Maximum Average Forward Rectified Current at TC=60°C	$I_{(AV)}$	25					A
Peak Forward Surge Current 8.3 ms Single Half Sine-Wave Superimposed on Rated Load (JEDEC method)	$I_{FSM}$	400					A
Maximum Forward Voltage at 12.5A DC and 25°C	$V_F$	1.1					V
Maximum Reverse Current at TA=25°C at Rated DC Blocking Voltage TA=125°C	$I_R$	10 1.0					$\mu A$ mA
Operating and Storage Temperature Range	$T_j, T_{stg}$	-55 ~ +150					°C

(1) Measured at 1 MHz and applied reverse voltage of 4 V D.C

(2) Thermal Resistance Junction to Case, Lead and Ambient.

FIG.1-MAXIMUM FORWARD SURGE CURRENT

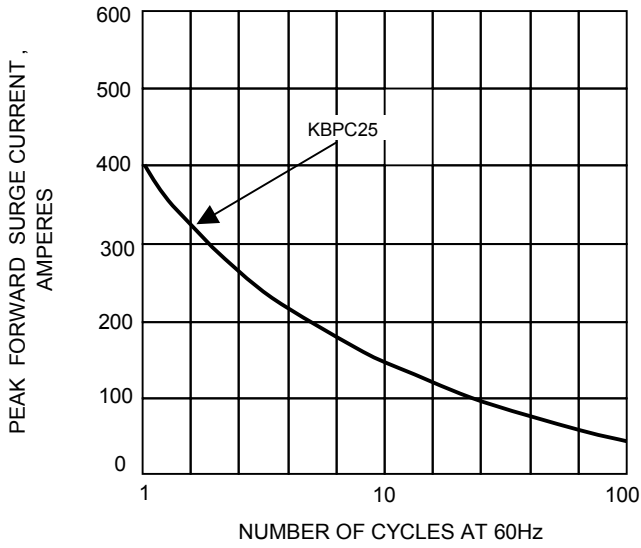

FIG.2- DERATING CURVE  
OUTPUT RECTIFIED CURRENT

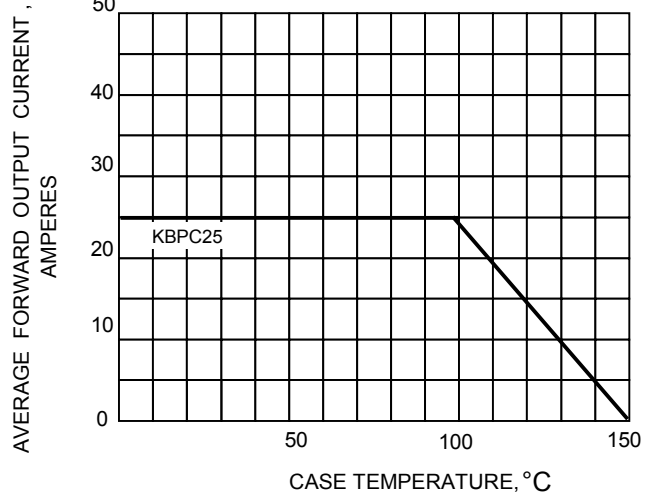

FIG.3-TYPICAL FORWARD CHARACTERISTICS

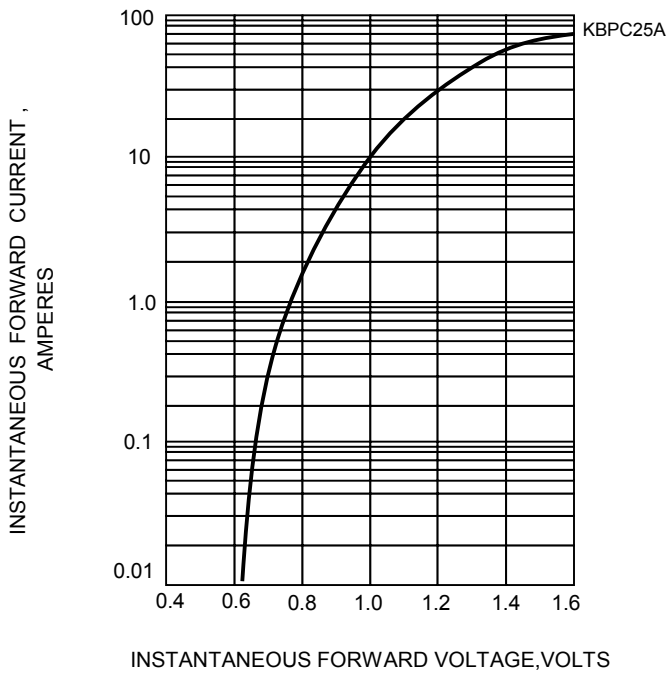
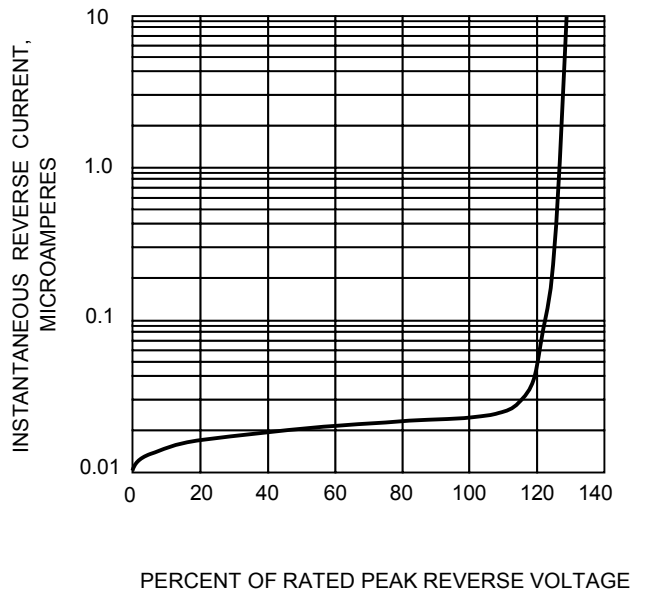

FIG.4-TYPICAL REVERSE CHARACTERISTICS



Package Outline

KBPC

KBPC-W

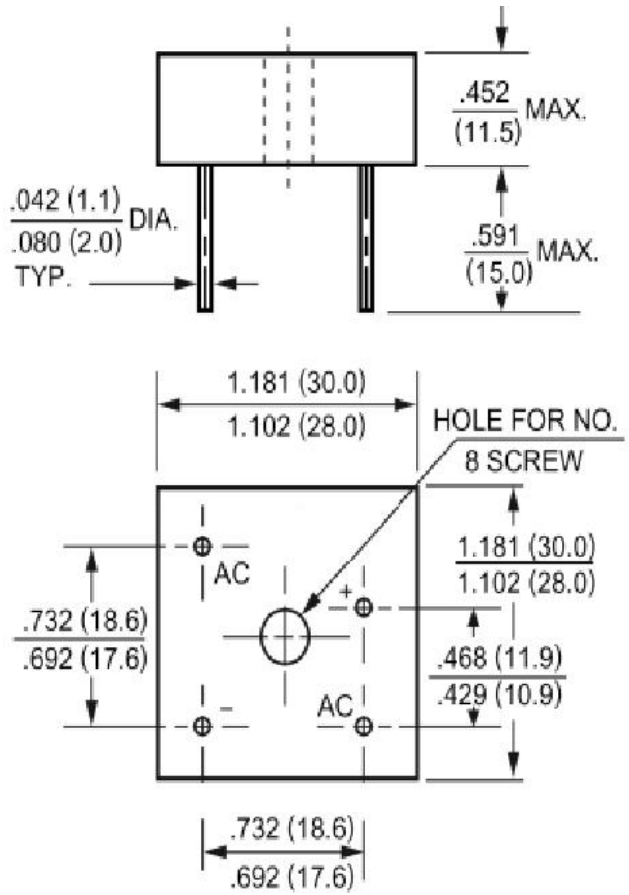
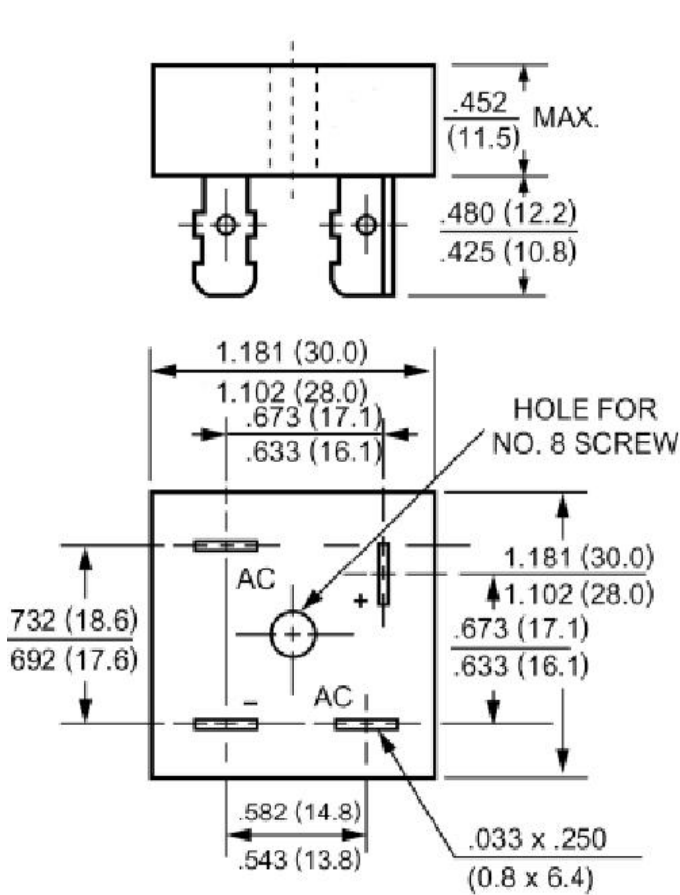

Summary of Packing Options

Package	Package Description	Packing Quantity	Industry Standard
KBPC	BOX	50	EIA-481-1
KBPC-W	BOX	50	EIA-481-1

## X-ON Electronics

Largest Supplier of Electrical and Electronic Components

*Click to view similar products for [Bridge Rectifiers](#) category:*

*Click to view products by [YFW Electronics](#) manufacturer:*

Other Similar products are found below :

[MB252](#) [MB356G](#) [MB358G](#) [GBJ1504-BP](#) [GBU10B-BP](#) [GBU15K-BP](#) [GBU4A-BP](#) [GBU4D-BP](#) [DB101-BP](#) [DF01](#) [DF10SA-E345](#) [KBPC50-10S](#) [RS405GL-BP](#) [GBJ1502-BP](#) [GBU6M](#) [TB102M](#) [MB1510](#) [MB86](#) [TL401G](#) [MDA920A2](#) [TU602](#) [TU810](#) [MP5010W-BP](#) [MP501W-BP](#) [MP502-BP](#) [KBPC25-02](#) [VBO160-12NO7](#) [VS-110MT120KPBF](#) [VS-60MT80KPBF](#) [DB105-BP](#) [DF1510S](#) [VS-40MT160PAPBF](#) [GBU4G-BP](#) [GSIB15A80-E3/45](#) [DB104-BP](#) [D3SB60](#) [TB354](#) [GBJ2504-BP](#) [26MB100A](#) [B1S-G](#) [VS-40MT160KPBF](#) [VUO162-16NO7](#) [ABS10-G](#) [GBU6B-BP](#) [GBJ1508-BP](#) [BR5010-G](#) [ABS6-G](#) [B125C800G-E4/51](#) [MSB15MH-13](#) [LBS10-13](#)