

**NPN Plastic-Encapsulate Transistors**

**High-Voltage Fast-Switching**

**Applications :**

◆Electronic Ballasts For Fluorescent Lighting And Changer

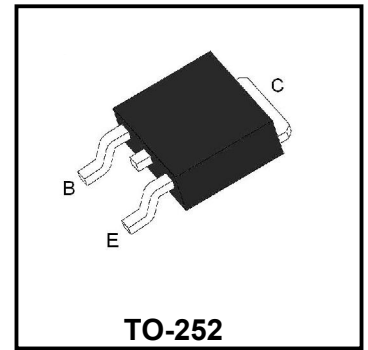

**Absolute Maximum Ratings (Ta=25°C)**

Parameter	Symbol	Value	Unit
Collector-Base Voltage	$BV_{CBO}$	700	V
Collector-Emitter Voltage	$BV_{CEO}$	480	V
Emitter-Base Voltage	$BV_{EBO}$	9	V
Collector Current	$I_C$	1	A
Collector Power Dissipation	$P_C$	1.2	W
Junction Temperature	$T_j$	150	°C
Storage Temperature	$T_{stg}$	-55~+150	°C

**Electrical Characteristics (Ta=25°C)**

Parameter	Symbol	Conditions	Min	Typ	Max	Unit
Collector-base breakdown voltage	$BV_{CBO}$	$I_C = 100\mu A, I_E = 0$	700			V
Collector-emitter breakdown voltage	$BV_{CEO}$	$I_C = 1mA, I_B = 0$	480			V
Emitter-base breakdown voltage	$BV_{EBO}$	$I_E = 100\mu A, I_C = 0$	9			V
Collector cut-off current	$I_{CBO}$	$V_{CB} = 700V, I_E = 0$			1	mA
Collector cut-off current	$I_{CEO}$	$V_{CE} = 400V, I_B = 0$			10	mA
Emitter cut-off current	$I_{EBO}$	$V_{EB} = 9V, I_C = 0$			1	mA
DC current gain	$h_{FE}$	$V_{CE} = 2V, I_C = 0.5A$	8		40	
Collector-emitter saturation voltage	$V_{CE(sat)}$	$I_C = 0.5A, I_B = 0.1A$			0.5	V
Base-emitter saturation voltage	$V_{BE(sat)}$	$I_C = 0.5A, I_B = 0.1A$ $I_C = 1A, I_B = 0.25A$			1.0 1.2	V
Transition frequency	$f_T$	$V_{CE} = 10V, I_B = 0.1A$	8			MHz

Typical Characteristics

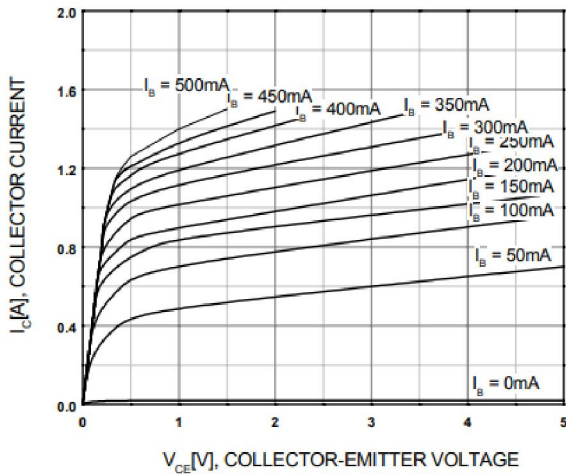

Figure 1. Static Characteristic

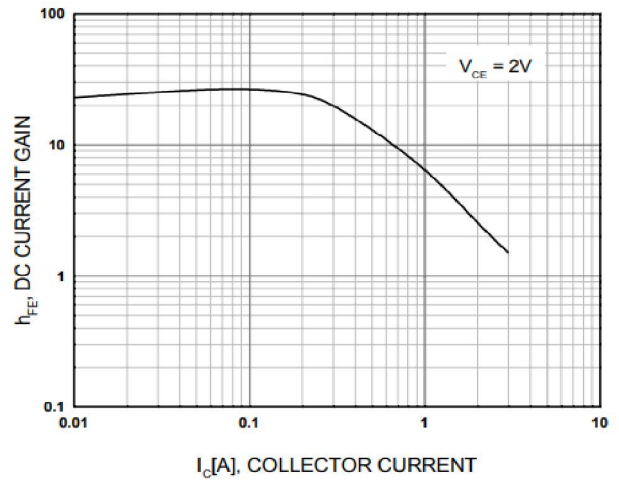

Figure 2. DC current Gain

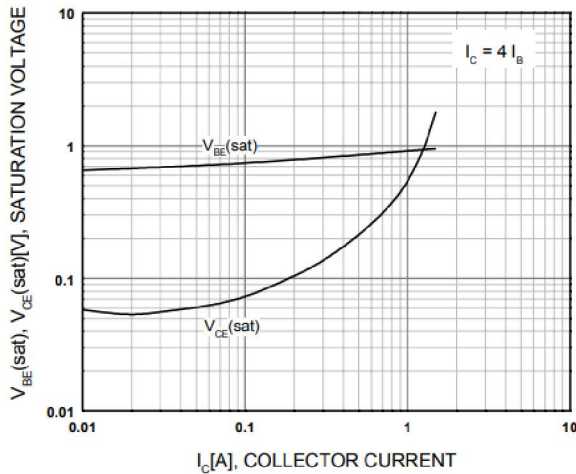

Figure 3. Base-Emitter Saturation Voltage  
Collector-Emitter Saturation Voltage

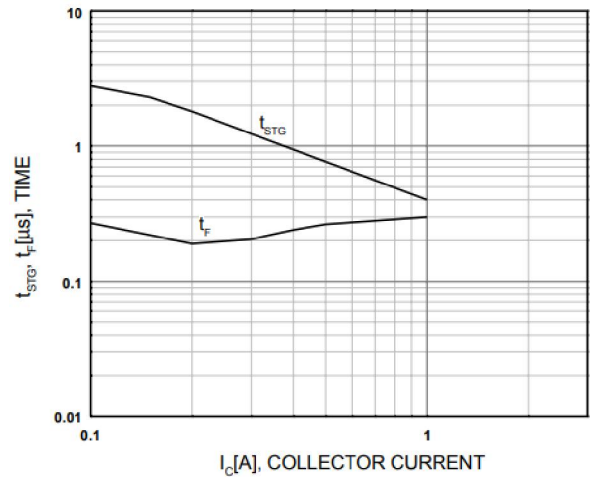

Figure 4. Switching Time

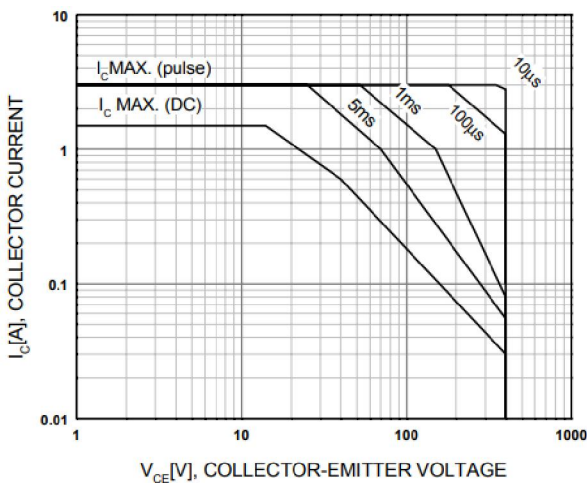

Figure 5. Safe Operating Area

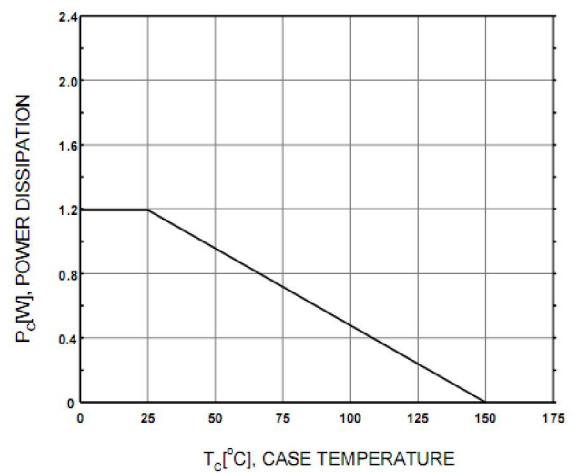

Figure 6. Power Derating

**Package Dimensions**

**TO-252**

Dim	Millimeter		Inches	
	Min.	Max.	Min.	Max.
A	2.20	2.50	0.087	0.094
A1	1.00	1.40	0.039	0.055
A2	0.00	0.15	0.000	0.006
b	0.50	0.70	0.020	0.028
b1	0.70	0.90	0.028	0.035
c	0.40	0.60	0.016	0.024
c1	0.40	0.60	0.016	0.024
D	6.20	6.70	0.244	0.264
D1	5.10	5.50	0.201	0.217
E	5.50	6.00	0.217	0.236
e	2.20	2.40	0.087	0.094
e1	4.40	4.80	0.173	0.189
L	9.70	10.40	0.382	0.409
L1	1.40	1.70	0.055	0.063
L2	0.60	1.20	0.024	0.047

**Product Specification Classification**

Part Number	Package	Marking	Pack
MJE13002	TO-252	YFW MJE13002 XXXXX	2500PCS/Tape

## X-ON Electronics

Largest Supplier of Electrical and Electronic Components

*Click to view similar products for [Bipolar Transistors - BJT category](#):*

*Click to view products by [YFW Electronics manufacturer](#):*

Other Similar products are found below :

[BC559C](#) [MCH4017-TL-H](#) [MMBT-2369-TR](#) [BC546/116](#) [NJVMJD148T4G](#) [NTE16](#) [NTE195A](#) [IMX9T110](#) [2N4401-A](#) [2N6728](#) [2SA1419T-TD-H](#) [2SB1204S-TL-E](#) [2SC5488A-TL-H](#) [FMC5AT148](#) [2N2369ADCSM](#) [2N2907A](#) [2N3904-NS](#) [2N5769](#) [2SC4618TLN](#) [CPH6501-TL-E](#) [BC856BW-13-F](#) [US6T6TR](#) [BAX18/A52R](#) [BC556/112](#) [IMZ2AT108](#) [MMST8098T146](#) [MCH6102-TL-E](#) [BC846B-13-F](#) [2N3879](#) [30A02MH-TL-E](#) [NTE13](#) [NTE282](#) [NTE323](#) [NTE350](#) [NTE81](#) [JANTX2N2920L](#) [JANSR2N2907AUB](#) [CMLT3946EG TR](#) [SNSS40600CF8T1G](#) [CMLT3906EG TR](#) [GRP-DATA-JANS2N2907AUB](#) [GRP-DATA-JANS2N2222AUA](#) [MMDT3946FL3-7](#) [2N4240](#) [JANS2N3019](#) [MSB30KH-13](#) [2N2221AUB](#) [2SD1815T-TL-E](#) [2N6678](#) [2N2907Ae4](#)