

**Super Fast Rectifiers**

**Reverse Voltage - 200V**

**Forward Current - 16A**

**FEATURES**

- Glass passivated chip junctions
- Super fast recovery time for switching mode application
- High Forward Surge Capability
- Low Reverse Current
- Lead free in compliance with EU RoHS 2011/65/EU directive

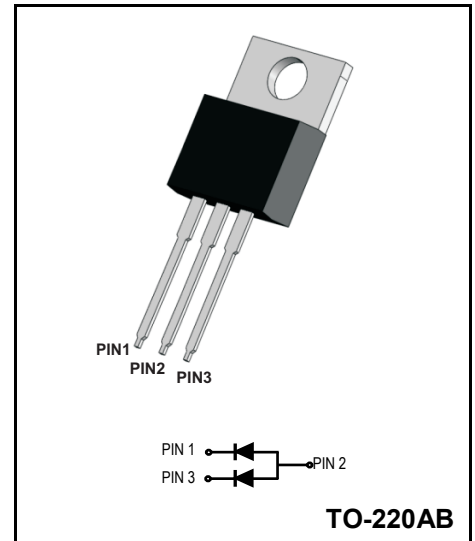

**MECHANICAL DATA**

- Circuit figure: Common Cathode
- Leads: Solderable per mil-std-202, Method 208
- Polarity: as marked
- Mounting torque: 5 in-lbs maximum
- Terminals: Puretin plated
- Weight: TO-220AB 1.85 grams

**MAXIMUM RATINGS AND ELECTRICAL CHARACTERISTICS (TA=25°C)**

RATINGS	SYMBOL	Value	Units
Maximum repetitive reverse voltage	$V_{RRM}$	200	V
Maximum RMS voltage	$V_{RMS}$	140	V
Maximum DC blocking voltage	$V_{DC}$	200	V
Maximum average forward current	$I_{AV}$	16	A
Peak forward surge current, 8.3ms single half sine-wave superimposed on rated load	$I_{FSM}$	250	A
Typical thermal resistance per diode (Note 1)	$R_{\theta-JC}$	2.5	°C/W
Operation Junction Temperature and Storage Temperature	$T_J, T_{STG}$	-55 ~ +150	°C
<b>CHARACTERISTICS</b>			
Typical forward voltage per leg at 8A	$V_F$	1.00	V
Maximum average reverse current at rated DC blocking voltage	$I_R$	5 250	$\mu A$
Typical reverse recovery time (Note 2)	$T_{RR}$	35	nS

Notes: 1. Thermal resistance from junction to case.  
2. Test conditions:  $I_F=0.5A, I_R=1.0A, I_{RR}=0.25A.$

**Ratings And Characteristic Curves**

FIG. 1 - TYPICAL FORWARD CURRENT DERATING CURVE

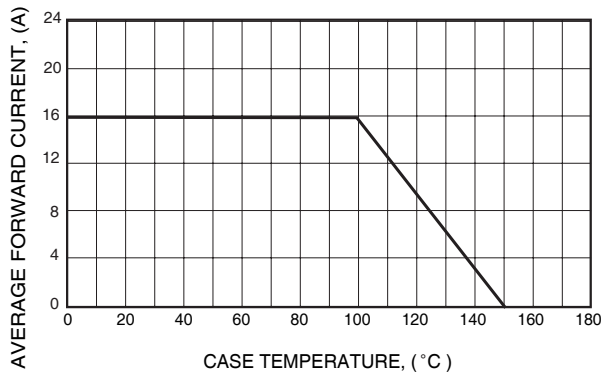

FIG. 3 - MAXIMUM NON-REPETITIVE FORWARD SURGE CURRENT

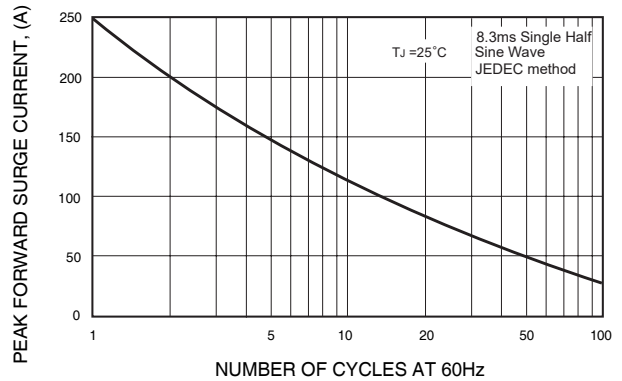

FIG. 4 - TYPICAL REVERSE CHARACTERISTICS

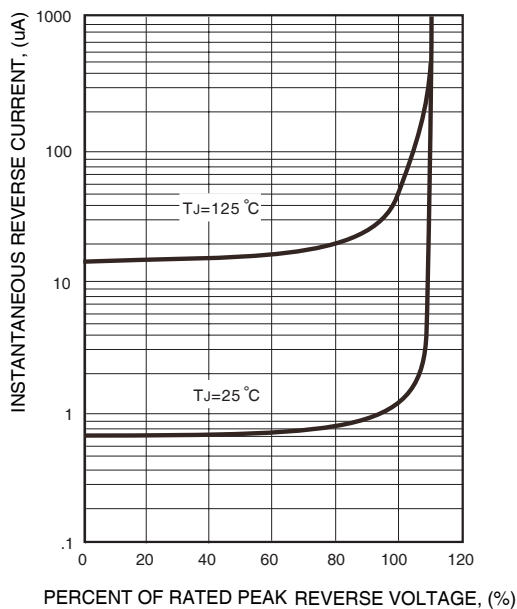

FIG. 2 - TYPICAL INSTANTANEOUS FORWARD CHARACTERISTICS

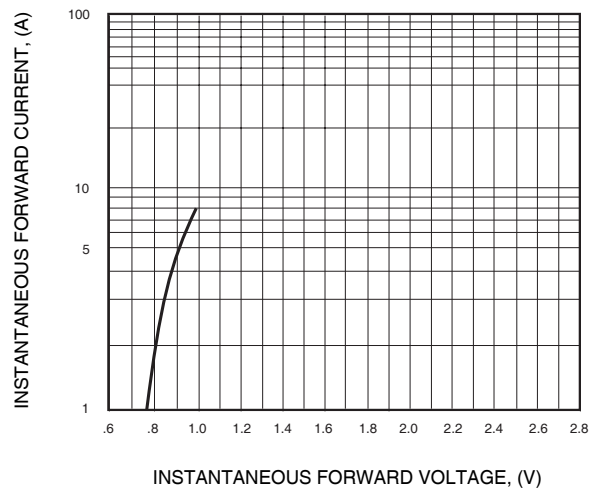
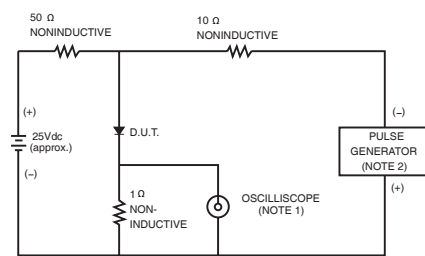
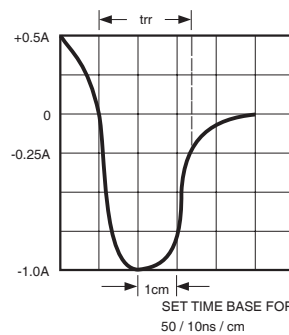

FIG.6- TEST CIRCUIT DIAGRAM AND REVERSE RECOVERY TIME CHARACTERISTICS



NOTES: 1. Rise Time= 7ns max., Input Impedance= 1 megohm,22pF.  
2. Rise Time= 10ns max., Source Impedance= 50 ohms.



Package outline Dimensions in millimeters

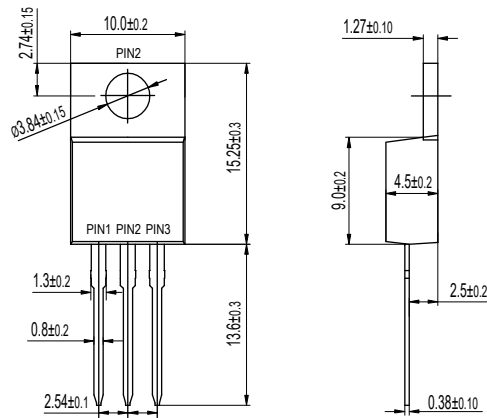

## X-ON Electronics

Largest Supplier of Electrical and Electronic Components

*Click to view similar products for [Rectifiers](#) category:*

*Click to view products by [YFW Electronics](#) manufacturer:*

Other Similar products are found below :

[70HFR40](#) [FR105 R0](#) [RL252-TP](#) [1N5397](#) [1N4005-TR](#) [1N4007-BP](#) [UFS120Je3/TR13](#) [20ETS12S](#) [RRE02VS6SGTR](#) [MS306](#) [A1N5404G-G](#)  
[CRF02\(T5L,TEMQ\)](#) [ACGRB207-HF](#) [CLH07\(TE16L,Q\)](#) [CLH03\(TE16L,Q\)](#) [1N5395-TP](#) [UES1302](#) [ACGRC307-HF](#) [ACEFC304-HF](#) [DZ-](#)  
[1380](#) [85HFR60](#) [40HFR60](#) [70HF120](#) [85HFR80](#) [SCF7500](#) [SM100](#) [ACGRA4001-HF](#) [SKN70/08](#) [NTE5819](#) [NTE5827](#) [NTE5828](#) [NTE5911](#)  
[NTE5915](#) [NTE6104](#) [NTE6163](#) [NTE6164](#) [NTE6165](#) [NTE6364](#) [TSD3G](#) [SET130312](#) [NRVUS110VT3G](#) [UES1106](#) [UES1306](#)  
[NRVUS240VT3G](#) [D5FE60-5063](#) [R4000GPS-TP](#) [D4015L56TP](#) [UES1306HR2](#) [FX20K120](#) [D20XB60-7101](#)