

Super Fast Rectifiers

Reverse Voltage - 600V

Forward Current - 20A

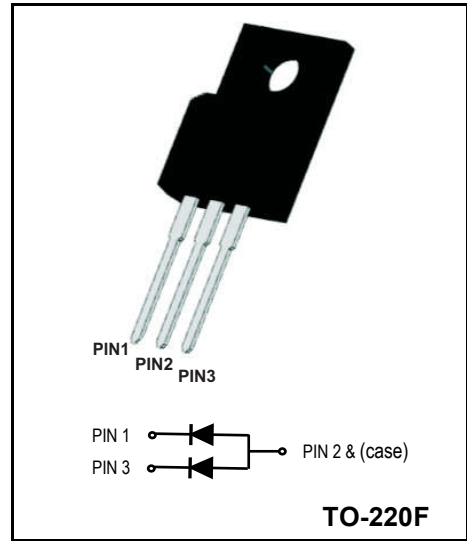

FEATURES

- Glass passivated chip junctions
- Super fast recovery time for switching mode application
- High Forward Surge Capability
- Low Reverse Current
- Lead free in compliance with EU RoHS 2011/65/EU directive

MECHANICAL DATA

- Circuit figure: Common Cathode
- Leads: Solderable per mil-std-202, Method 208
- Polarity: as marked
- Mounting torque: 5 in-lbs maximum
- Terminals: Puretin plated
- Weight: TO-220F 1.70 grams

MAXIMUM RATINGS AND ELECTRICAL CHARACTERISTICS (TA=25°C)

RATINGS	SYMBOL	Value	Units
Maximum repetitive reverse voltage	V_{RRM}	600	V
Maximum RMS voltage	V_{RMS}	420	V
Maximum DC blocking voltage	V_{DC}	600	V
Maximum average forward current	I_{AV}	20	A
Peak forward surge current, 8.3ms single half sine-wave superimposed on rated load	I_{FSM}	300	A
Typical thermal resistance per diode (Note 1)	$R_{\theta-JC}$	4.0	°C/W
Operation Junction Temperature and Storage Temperature	T_J, T_{STG}	-55 ~ +150	°C
CHARACTERISTICS			
Typical forward voltage per leg at 10A	V_F	1.65	V
Maximum average reverse current at rated DC blocking voltage	I_R	5 250	μA
Typical reverse recovery time (Note 2)	T_{RR}	35	nS

Notes: 1. Thermal resistance from junction to case.
2. Test conditions: $I_F=0.5A, I_R=1.0A, I_{RR}=0.25A.$

Ratings And Characteristic Curves

FIG. 1 - TYPICAL FORWARD CURRENT DERATING CURVE

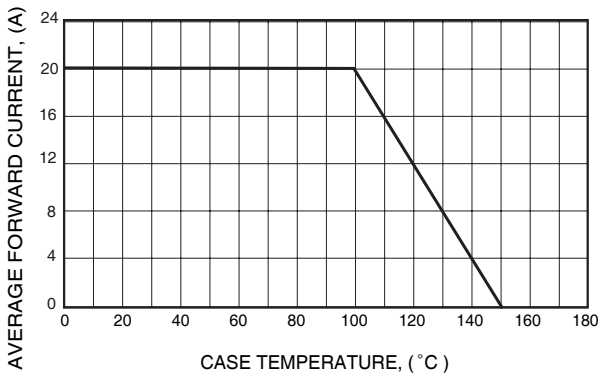

FIG. 3 - MAXIMUM NON-REPETITIVE FORWARD SURGE CURRENT

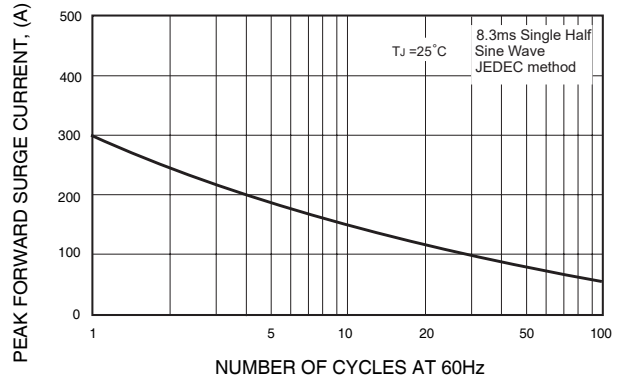

FIG. 4 - TYPICAL REVERSE CHARACTERISTICS

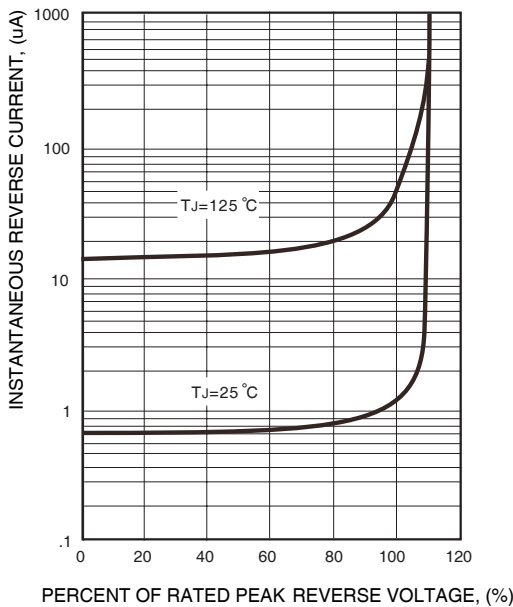

FIG. 2 - TYPICAL INSTANTANEOUS FORWARD CHARACTERISTICS

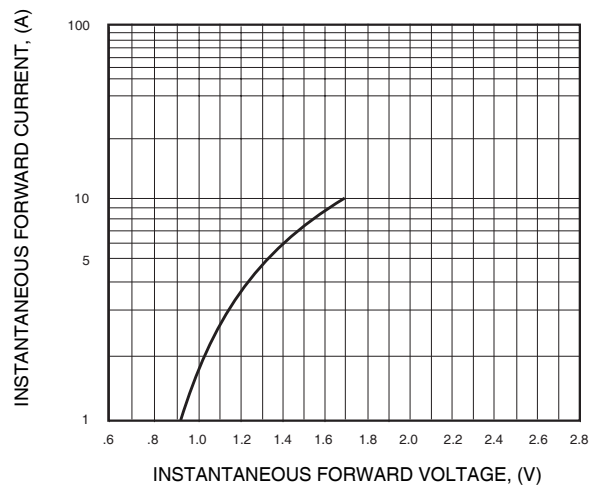
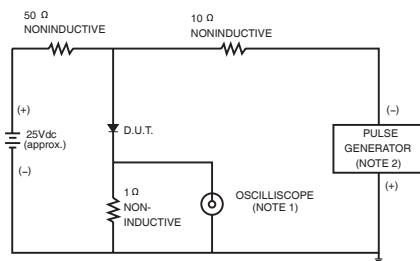
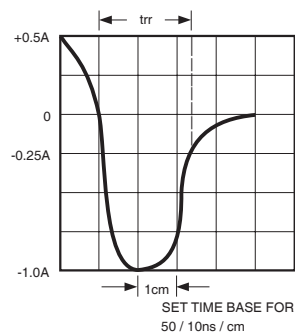

FIG.6- TEST CIRCUIT DIAGRAM AND REVERSE RECOVERY TIME CHARACTERISTICS



NOTES: 1. Rise Time= 7ns max., Input Impedance= 1 megohm, 22pF.
2. Rise Time= 10ns max., Source Impedance= 50 ohms.



Package Outline Dimensions Millimeters

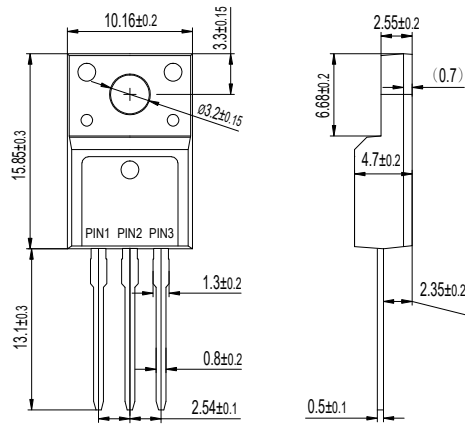

X-ON Electronics

Largest Supplier of Electrical and Electronic Components

Click to view similar products for [Rectifiers](#) category:

Click to view products by [YFW Electronics](#) manufacturer:

Other Similar products are found below :

[70HFR40](#) [FR105 R0](#) [RL252-TP](#) [1N5397](#) [1N4005-TR](#) [1N4007-BP](#) [UFS120Je3/TR13](#) [20ETS12S](#) [RRE02VS6SGTR](#) [MS306](#) [A1N5404G-G](#)
[CRF02\(T5L,TEMQ\)](#) [ACGRB207-HF](#) [CLH07\(TE16L,Q\)](#) [CLH03\(TE16L,Q\)](#) [1N5395-TP](#) [UES1302](#) [ACGRC307-HF](#) [ACEFC304-HF](#) [DZ-](#)
[1380](#) [85HFR60](#) [40HFR60](#) [70HF120](#) [85HFR80](#) [SCF7500](#) [SM100](#) [ACGRA4001-HF](#) [SKN70/08](#) [NTE5819](#) [NTE5827](#) [NTE5828](#) [NTE5911](#)
[NTE5915](#) [NTE6104](#) [NTE6163](#) [NTE6164](#) [NTE6165](#) [NTE6364](#) [TSD3G](#) [SET130312](#) [NRVUS110VT3G](#) [UES1106](#) [UES1306](#)
[NRVUS240VT3G](#) [D5FE60-5063](#) [R4000GPS-TP](#) [D4015L56TP](#) [UES1306HR2](#) [FX20K120](#) [D20XB60-7101](#)