

**1 Channel Ultra-low Capacitance ESD Protection**

**Features**

- ◆ Ultra-Low capacitance: 0.05pF(typ.)
- ◆ Low leakage current (<100nA)
- ◆ Fast response time (<1ns)
- ◆ Bi-directional, single line protection
- ◆ IEC 61000-4-2 (ESD Air): 15kV
- ◆ IEC 61000-4-2 (ESD Contact): 8kV

**Application**

- ◆ USB 3.0/3.1
- ◆ HDMI 1.3/1.4/2.0
- ◆ RF Antenna
- ◆ SATA and eSATA Interface

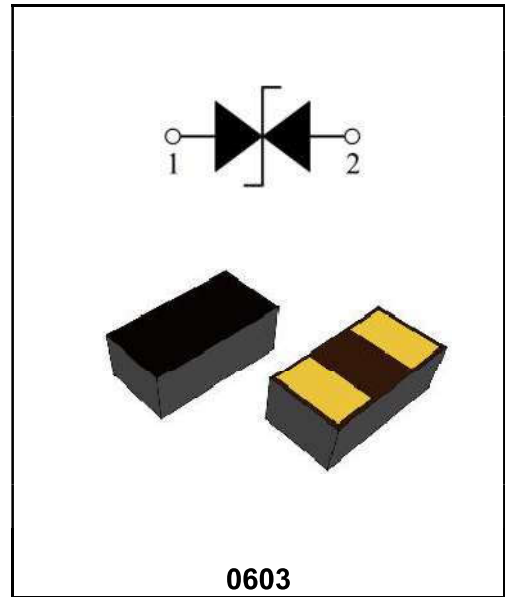

**Order Information**

| Part Number | Package | Size (mm)      | Delivery Form | Delivery Quantity |
|-------------|---------|----------------|---------------|-------------------|
| PESD0603B05 | 0603    | 1.60X0.80X0.40 | 7" T&R        | 5000PCS/Tape      |

**Limiting Values(TA = 25 °C, unless otherwise specified)**

| Symbol | Parameter                       | Conditions                       | Min | Max | Unit |
|--------|---------------------------------|----------------------------------|-----|-----|------|
| VESD   | Electrostatic Discharge Voltage | IEC 61000-4-2; Contact Discharge | -   | 8   | kV   |
|        |                                 | IEC 61000-4-2; Air Discharge     | -   | 15  | kV   |
| TA     | Operating Temperature Range     | -                                | -40 | 90  | °C   |
| Tstg   | Storage Temperature Range       | -                                | -55 | 125 | °C   |

**Electrical Characteristics(TA = 25 °C unless otherwise specified)**

| Symbol | Parameter                    | Conditions                           | Min | Typ. | Max | Unit |
|--------|------------------------------|--------------------------------------|-----|------|-----|------|
| VDC    | Continuous Operating Voltage | -                                    | -   | -    | 5.0 | V    |
| VT     | Trigger Voltage              | IEC61000-4-2 8kV contact discharge   | -   | 450  | -   | V    |
| VC     | Clamping Voltage             | IEC61000-4-2 8kV contact discharge   | -   | 40   | -   | V    |
| IL     | Leakage Current              | DC 5 V shall be applied on component | -   | -    | 100 | nA   |
| CJ     | Capacitance                  | Measured at 10MHz                    | -   | 0.05 | -   | pF   |

Typical Characteristics

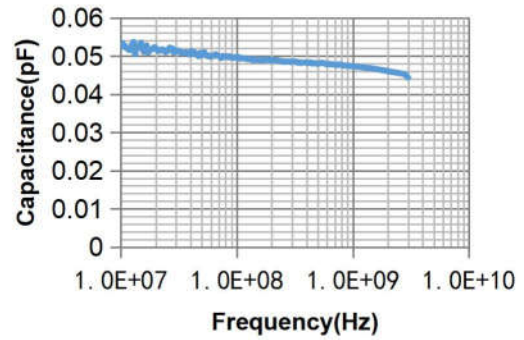
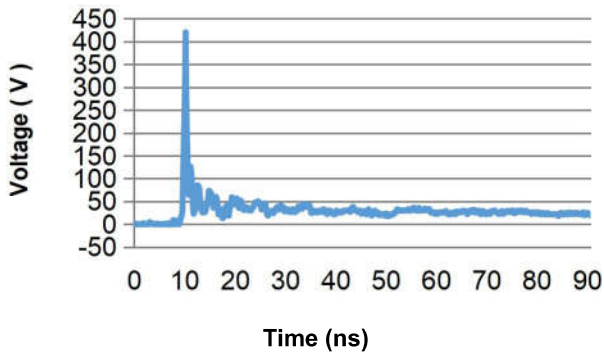

ESD Protection for Signal Line

The PESD is designed for the protection of one bidirectional data line from ESD damage.

1. Place the PESD as close to the input terminal or connector as possible.
2. Minimize the path length between the PESD and the protected signal line.
3. Use ground planes whenever possible.

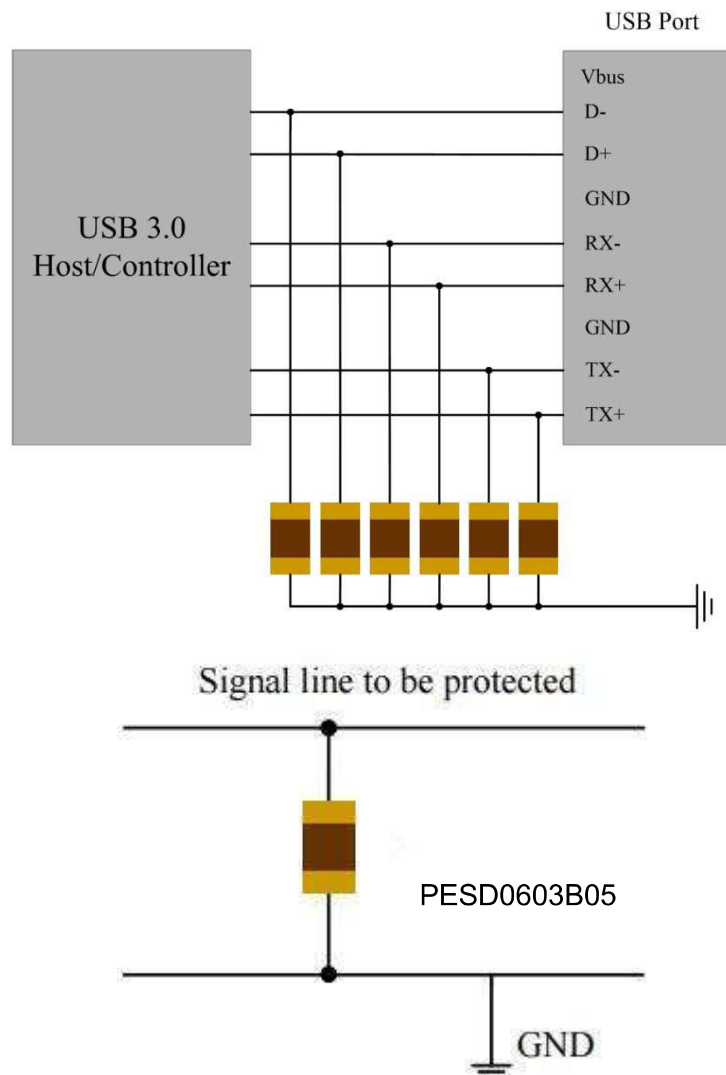

Package Dimension

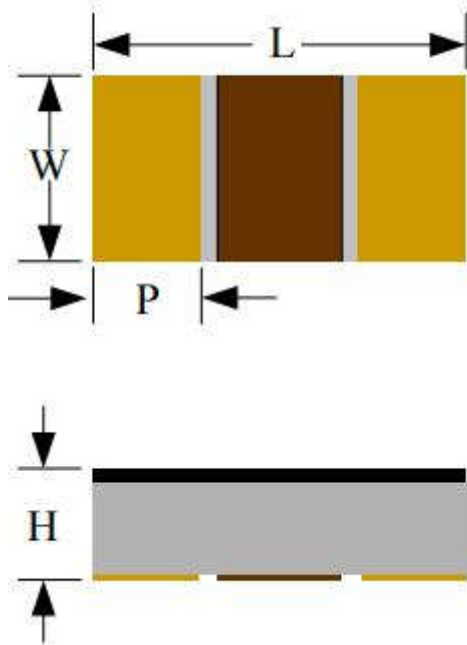

Recommended Solder Pad Footprint

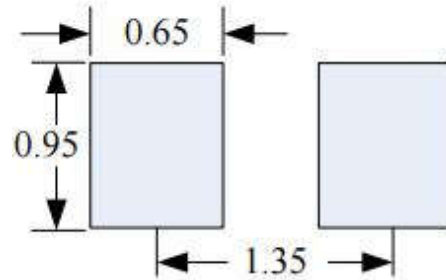

**\*Sizes in mm**

Notes:

This solder pad layout is for reference purposes only.

| Dimension | Unit: Millimeters |      |
|-----------|-------------------|------|
|           | Min.              | Max. |
| L         | 1.45              | 1.75 |
| W         | 0.70              | 0.95 |
| P         | 0.20              | 0.50 |
| H         | 0.26              | 0.46 |

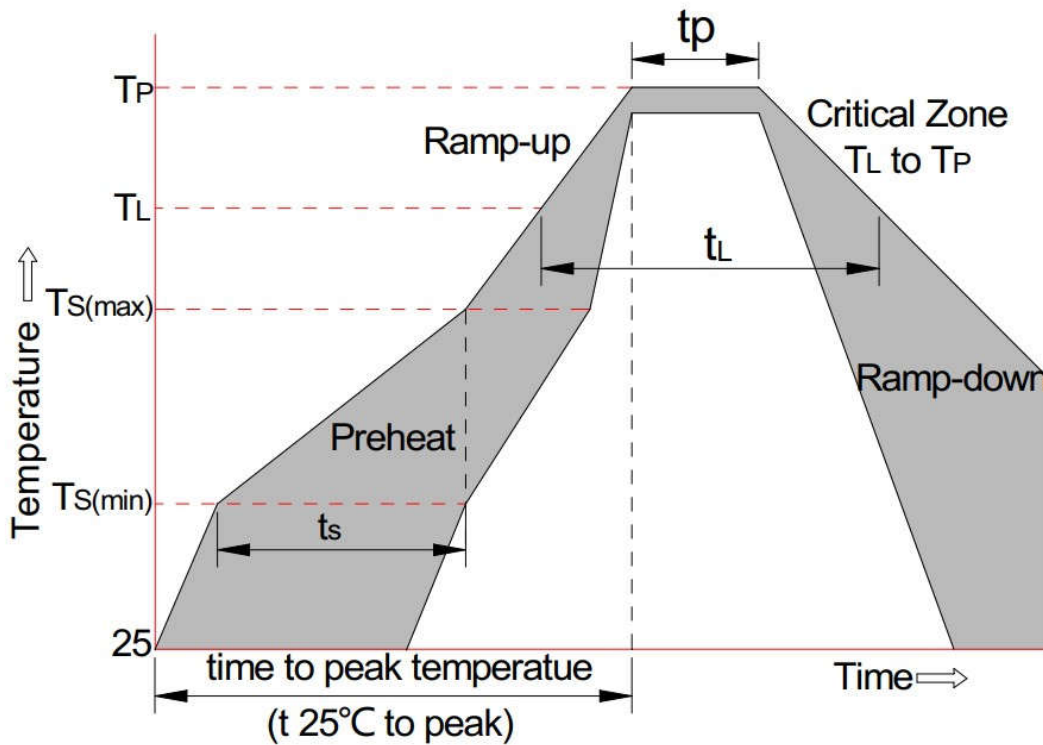

| Reflow Condition                                   |                             | Pb-Free Assembly |
|--|-----------------------------|------------------|
| Pre-heat   | -Temperature Min (Ts(min))  | +150°C           |
|  | -Temperature Max(Ts(max))   | +200°C           |
|  | -Time (Min to Max) (ts)     | 60-180 secs.     |
| Average ramp up rate (Liquid us Temp (TL) to peak) |                             | 3°C/sec. Max     |
| Ts(max) to TL - Ramp-up Rate                       |                             | 3°C/sec. Max     |
| Reflow   | -Temperature(TL)(Liquid us) | +217°C           |
|  | -Temperature(tL)            | 60-150 secs.     |
| Peak Temp (Tp)                                     |                             | +260(+0/-5)°C    |
| Time within 5°C of actual Peak Temp (tp)           |                             | 30 secs. Max     |
| Ramp-down Rate                                     |                             | 6°C/sec. Max     |
| xTime 25°C to Peak Temp (TP)                       |                             | 8 min. Max       |
| Do not exceed                                      |                             | +260°C           |

## X-ON Electronics

Largest Supplier of Electrical and Electronic Components

*Click to view similar products for [ESD Suppressors / TVS Diodes](#) category:*

*Click to view products by [YFW Electronics](#) manufacturer:*

Other Similar products are found below :

[60KS200C](#) [D18V0L1B2LP-7B](#) [D5V0F4U5P5-7](#) [NTE4902](#) [P4KE27CA](#) [P6KE11CA](#) [P6KE8.2A](#) [SA60CA](#) [SA64CA](#) [SMBJ12CATR](#)  
[SMBJ33CATR](#) [SMBJ6.5A](#) [SMBJ8.0A](#) [ESD101-B1-02ELS](#) [E6327](#) [ESD112-B1-02EL](#) [E6327](#) [ESD7451N2T5G](#) [19180-510](#) [CPDT-5V0USP-](#)  
[HF](#) [3.0SMCJ33CA-F](#) [3.0SMCJ36A-F](#) [HSPC16701B02TP](#) [JANTX1N6126A](#) [D3V3Q1B2DLP3-7](#) [D55V0M1B2WS-7](#) [SCM1293A-04SO](#)  
[ESD200-B1-CSP0201](#) [E6327](#) [SM12-7](#) [CEN955](#) [W/DATA](#) [VESD12A1A-HD1-GS08](#) [CPDQC5V0-HF](#) [D1213A-01LP4-7B](#) [ESD101-B1-02EL](#)  
[E6327](#) [AOZ8808DI-03](#) [5KP15A](#) [5KP48A](#) [5KP90A](#) [ESD3V3D7-TP](#) [15KPA36A-LF](#) [P4KE56CA](#) [P4KE68A](#) [P4KE91CATR](#) [P6KE120A](#)  
[P6KE13CA](#) [P6KE43CA](#) [P6KE6.8CA](#) [P6KE8.2](#) [P6SMBJ20CA](#) [JANTX1N6072A](#) [SR2835ESKG](#) [SA90CA](#)