

## Surface Mount Fast Recovery Rectifiers

Reverse Voltage - 50 to 1000 V

Forward Current - 1 A

### FEATURES

- ◆ For surface mounted applications
- ◆ Low profile package
- ◆ Glass Passivated Chip Junction
- ◆ Easy to pick and place
- ◆ Fast reverse recovery time
- ◆ Lead free in comply with EU RoHS 2011/65/EU directives



### MECHANICAL DATA

- ◆ Case: SMAF
- ◆ Terminals: Solderable per MIL-STD-750, Method 2026
- ◆ Approx. Weight: 27mg / 0.00095oz

### Absolute Maximum Ratings and characteristics

Ratings at 25 °C ambient temperature unless otherwise specified.  
Single phase half-wave 60 Hz, resistive or inductive load, for capacitive load current derate by 20 %.

### Pinning

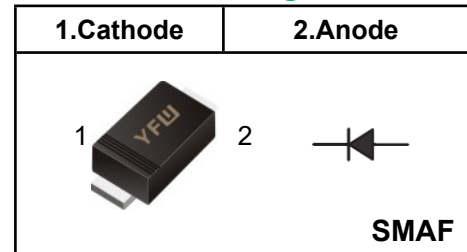

### Marking Code

RS1AF	RS1A
RS1BF	RS1B
RS1DF	RS1D
RS1GF	RS1G
RS1JF	RS1J
RS1KF	RS1K
RS1MF	RS1M

Parameter	Symbols	RS1AF	RS1BF	RS1DF	RS1GF	RS1JF	RS1KF	RS1MF	Units
Maximum Repetitive Peak Reverse Voltage	$V_{RRM}$	50	100	200	400	600	800	1000	V
Maximum RMS voltage	$V_{RMS}$	35	70	140	280	420	560	700	V
Maximum DC Blocking Voltage	$V_{DC}$	50	100	200	400	600	800	1000	V
Maximum Average Forward Rectified Current at $T_c = 125\text{ }^\circ\text{C}$	$I_{F(AV)}$	1							A
Peak Forward Surge Current 8.3 ms Single Half Sine Wave Superimposed on Rated Load	$I_{FSM}$	30							A
Maximum Instantaneous Forward Voltage at 1 A	$V_F$	1.3							V
Maximum DC Reverse Current $T_a = 25\text{ }^\circ\text{C}$ at Rated DC Blocking Voltage $T_a = 125\text{ }^\circ\text{C}$	$I_R$	5 100							$\mu\text{A}$
Typical Junction Capacitance at $V_R=4\text{V}, f=1\text{MHz}$	$C_j$	15							pF
Maximum Reverse Recovery Time <sup>(1)</sup>	$T_{rr}$	150				250	500		nS
Typical Thermal Resistance <sup>(2)</sup>	$R_{\theta JA}$	80							$^\circ\text{C/W}$
Operating and Storage Temperature Range	$T_j, T_{stg}$	-55 ~ +150							$^\circ\text{C}$

(1) Measured with  $I_F=0.5\text{A}, I_R=1\text{A}, I_n=0.25\text{A}$

(2) P.C.B. mounted with 2.0" X 2.0" (5 X 5 cm) copper pad areas.

**Fig.1 Forward Current Derating Curve**

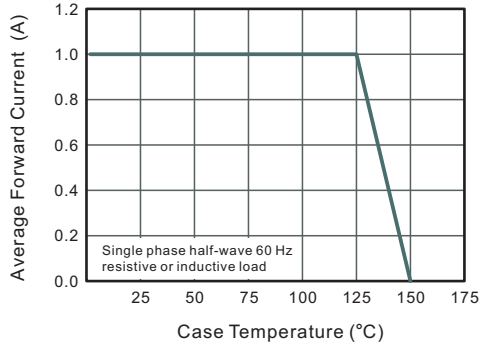

**Fig.2 Typical Reverse Characteristics**

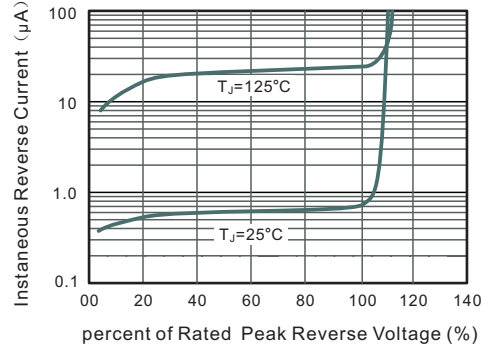

**Fig.3 Typical Instantaneous Forward Characteristics**

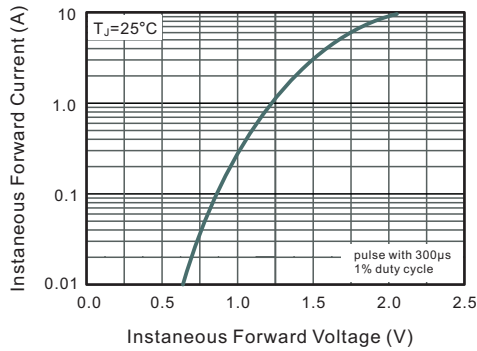

**Fig.4 Typical Junction Capacitance**

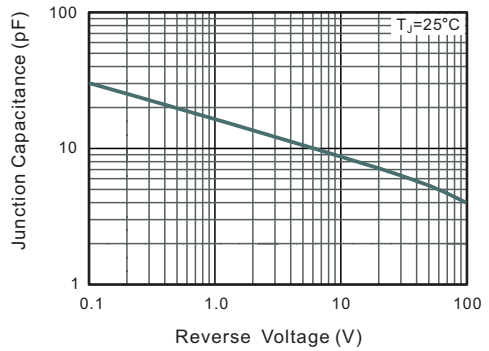

**Fig.5 Maximum Non-Repetitive Peak Forward Surge Current**

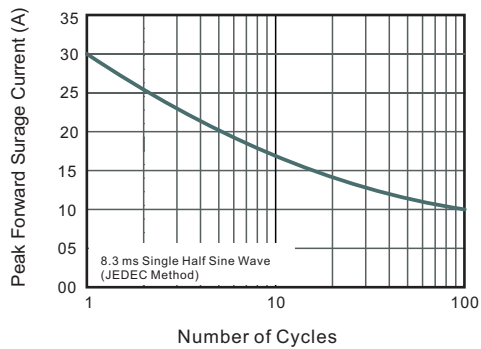

**Package Outline**

**SMAF**

Plastic surface mounted package; 2 leads

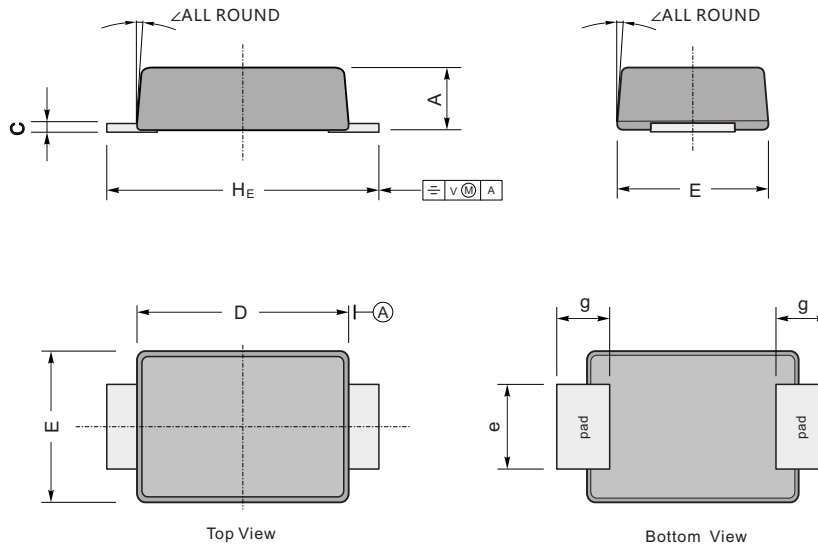

UNIT		A	C	D	E	e	g	H <sub>E</sub>	$\angle$
mm	max	1.1	0.20	3.7	2.7	1.6	1.2	4.9	7°
	min	0.9	0.12	3.3	2.4	1.3	0.8	4.4	
mil	max	43	7.9	146	106	63	47	193	
	min	35	4.7	130	94	51	31	173	

**The recommended mounting pad size**

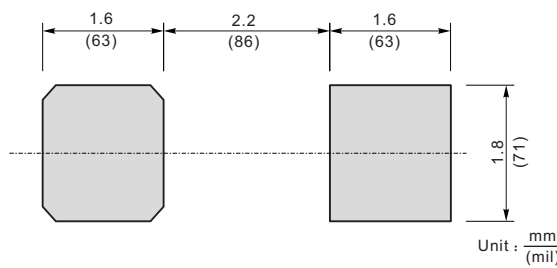

**Summary of Packing Options**

Package	Packing Description	Packing Quantity	Industry Standard
SMAF	Tape/Reel, 13" reel	10000	EIA-481-1
	Tape/Reel, 7" reel	3000	EIA-481-1

## X-ON Electronics

Largest Supplier of Electrical and Electronic Components

*Click to view similar products for [Rectifiers](#) category:*

*Click to view products by [YFW Electronics](#) manufacturer:*

Other Similar products are found below :

[70HFR40](#) [FR105 R0](#) [RL252-TP](#) [1N5397](#) [JANTX1N5634A](#) [1N4002G](#) [1N4005-TR](#) [JANS1N6640US](#) [481235F](#) [RRE02VS6SGTR](#) [067907F](#)  
[MS306](#) [US2JFL-TP](#) [A1N5404G-G](#) [CRS12\(T5L,TEMQ\)](#) [ACGRB207-HF](#) [CLH07\(TE16L,Q\)](#) [CLH03\(TE16L,Q\)](#) [ACGRC307-HF](#)  
[ACEFC304-HF](#) [DZ-1380](#) [NTE6356](#) [NTE6359](#) [JAN1N5555](#) [85HFR60](#) [40HFR60](#) [70HF120](#) [85HFR80](#) [D126A45C](#) [SCF7500](#) [SCHJ22.5K](#)  
[SM100](#) [SCPA2](#) [SDHD5K](#) [ACGRA4001-HF](#) [D1821SH45T PR](#) [D1251S45T](#) [NTE6358](#) [NTE5850](#) [NTE5819](#) [NTE5837](#) [NTE5892](#) [NTE5900](#)  
[NTE5911](#) [NTE5915](#) [NTE5921](#) [NTE6104](#) [NTE6105](#) [NTE6154](#) [NTE6158](#)