

Surface mount transient voltage suppressor power 400 watts

Stand-Off Voltage: 5.0V~440V

FEATURES

- ◆For surface mounted applications in order to optimize board space.
- ◆Low profile package.
- ◆Glass passivated junction.
- ◆Low inductance.
- ◆Plastic package has Underwriters Laboratory Flammability.

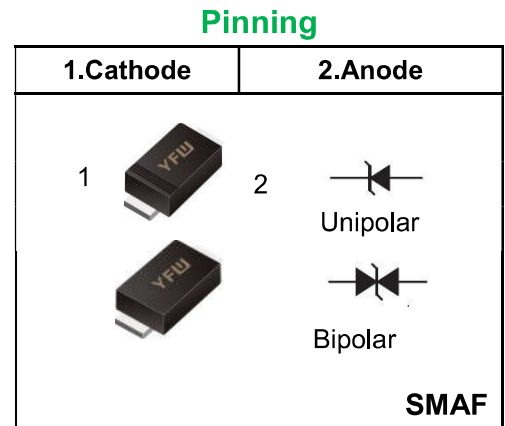

MECHANICAL DATA

- ◆Case: SMAF
- ◆Terminals: Solderable per MIL-STD-750, Method 2026
- ◆Approx. Weight: 27mg / 0.00095oz

Maximum Ratings and Electrical characteristics

Ratings at 25°C ambient temperature unless otherwise specified.

Parameter	Symbol	Value	Unit
Peak Pulse Power Dissipation on 10/1000us waveform	P_{PPM}	400	W
Peak Forward Surge Current (Note 2, Fig 4)	I_{FSM}	60	A
Peak Pulse Current on 10/1000 us waveform (Note 1, Fig 2)	I_{PPM}	see Table 1	A
ESD Voltage per IEC6100-4-2	Contact	V_{ESD1}	kV
	Air	V_{ESD2}	
Typical Junction Capacitance at VR=4V, f=1MHz	C_j	390	pF
Typical Thermal Resistance Junction to Ambient(Note 2)	$R_{\theta JA}$	120	°C
Operating Junction Temperature and Storage Temperature Range	T_J, T_{STG}	-55 to +175	°C

NOTES:

1. Non-repetitive current pulse, per Fig.3 and derated above TA = 25°C per Fig. 2.
2. Mounted on FR-4 PCB single-sided copper, mini pad.
3. Peak Forward Surge Current : 8.3ms single half sine-wave Superimposed on rated load (JEDEC method).
4. Peak pulse power waveform is 10/1000µS.

Characteristics at Ta = 25°C

Type		Reverse Stand-Off Voltage	Breakdown Voltage		Test Current	Reverse Leakage	Max. Clamp Voltage	Peak Pulse Current	Package	
			V _{BR} @ I _T						SMAF	
			V _{RRM}	Min					Max	Device Marking
Uni	Bi	V	V	V	Ma	Ma	V	A	Uni	Bi
SMAFJ5.0A	SMAFJ5.0CA	5	6.4	7	10	800	9.2	43.5	AE	WE
SMAFJ6.0A	SMAFJ6.0CA	6	6.67	7.37	10	800	10.3	38.8	AG	WG
SMAFJ6.5A	SMAFJ6.5CA	6.5	7.22	7.98	10	500	11.2	35.7	AK	WK
SMAFJ7.0A	SMAFJ7.0CA	7	7.78	8.6	10	200	12	33.3	AM	WM
SMAFJ7.5A	SMAFJ7.5CA	7.5	8.33	9.21	1	100	12.9	31	AP	WP
SMAFJ8.0A	SMAFJ8.0CA	8	8.89	9.83	1	50	13.6	29.4	AR	WR
SMAFJ8.5A	SMAFJ8.5CA	8.5	9.44	10.4	1	20	14.4	27.8	AT	WT
SMAFJ9.0A	SMAFJ9.0CA	9	10	11.1	1	10	15.4	26	AV	WV
SMAFJ10A	SMAFJ10CA	10	11.1	12.3	1	5	17	23.5	AX	WX
SMAFJ11A	SMAFJ11CA	11	12.2	13.5	1	1	18.2	22	AZ	WZ
SMAFJ12A	SMAFJ12CA	12	13.3	14.7	1	1	19.9	20.1	BE	XE
SMAFJ13A	SMAFJ13CA	13	14.4	15.9	1	1	21.5	18.6	BG	XG
SMAFJ14A	SMAFJ14CA	14	15.6	17.2	1	1	23.2	17.2	BK	XK
SMAFJ15A	SMAFJ15CA	15	16.7	18.5	1	1	24.4	16.4	BM	XM
SMAFJ16A	SMAFJ16CA	16	17.8	19.7	1	1	26	15.4	BP	XP
SMAFJ17A	SMAFJ17CA	17	18.9	20.9	1	1	27.6	14.5	BR	XR
SMAFJ18A	SMAFJ18CA	18	20	22.1	1	1	29.2	13.7	BT	XT
SMAFJ20A	SMAFJ20CA	20	22.2	24.5	1	1	32.4	12.3	BV	XV
SMAFJ22A	SMAFJ22CA	22	24.4	26.9	1	1	35.5	11.3	BX	XX
SMAFJ24A	SMAFJ24CA	24	26.7	29.5	1	1	38.9	10.3	BZ	XZ
SMAFJ26A	SMAFJ26CA	26	28.9	31.9	1	1	42.1	9.5	CE	YE
SMAFJ28A	SMAFJ28CA	28	31.1	34.4	1	1	45.4	8.8	CG	YG
SMAFJ30A	SMAFJ30CA	30	33.3	36.8	1	1	48.4	8.3	CK	YK
SMAFJ33A	SMAFJ33CA	33	36.7	40.6	1	1	53.3	7.5	CM	YM
SMAFJ36A	SMAFJ36CA	36	40	44.2	1	1	58.1	6.9	CP	YP
SMAFJ40A	SMAFJ40CA	40	44.4	49.1	1	1	64.5	6.2	CR	YR
SMAFJ43A	SMAFJ43CA	43	47.8	52.8	1	1	69.4	5.8	CT	YT
SMAFJ45A	SMAFJ45CA	45	50	55.3	1	1	72.7	5.5	CV	YV
SMAFJ48A	SMAFJ48CA	48	53.3	58.9	1	1	77.4	5.2	CX	YX
SMAFJ51A	SMAFJ51CA	51	56.7	62.7	1	1	82.4	4.9	CZ	YZ
SMAFJ54A	SMAFJ54CA	54	60	66.3	1	1	87.1	4.6	RE	ZE
SMAFJ58A	SMAFJ58CA	58	64.4	71.2	1	1	93.6	4.3	RG	ZG
SMAFJ60A	SMAFJ60CA	60	66.7	73.7	1	1	96.8	4.1	RK	ZK
SMAFJ64A	SMAFJ64CA	64	71.1	78.6	1	1	103	3.9	RM	ZM
SMAFJ70A	SMAFJ70CA	70	77.8	86	1	1	113	3.5	RP	ZP
SMAFJ75A	SMAFJ75CA	75	83.3	92.1	1	1	121	3.3	RR	ZR
SMAFJ78A	SMAFJ78CA	78	86.7	95.8	1	1	126	3.2	RT	ZT
SMAFJ85A	SMAFJ85CA	85	94.4	104	1	1	137	2.9	RV	ZV
SMAFJ90A	SMAFJ90CA	90	100	111	1	1	146	2.7	RX	ZX
SMAFJ100A	SMAFJ100CA	100	111	123	1	1	162	2.5	RZ	ZZ
SMAFJ110A	SMAFJ110CA	110	122	135	1	1	177	2.3	SE	VE
SMAFJ120A	SMAFJ120CA	120	133	147	1	1	193	2.1	SG	VG
SMAFJ130A	SMAFJ130CA	130	144	159	1	1	209	1.9	SK	VK
SMAFJ150A	SMAFJ150CA	150	167	185	1	1	243	1.6	SM	VM
SMAFJ160A	SMAFJ160CA	160	178	197	1	1	259	1.5	SP	VP
SMAFJ170A	SMAFJ170CA	170	189	209	1	1	275	1.5	SR	VR
SMAFJ180A	SMAFJ180CA	180	201	222	1	1	292	1.4	ST	VT
SMAFJ200A	SMAFJ200CA	200	224	247	1	1	324	1.2	SV	VV
SMAFJ220A	SMAFJ220CA	220	246	272	1	1	356	1.1	SX	VX
SMAFJ250A	SMAFJ250CA	250	279	309	1	1	405	1	SZ	VZ
SMAFJ300A	SMAFJ300CA	300	335	371	1	1	486	0.8	TE	UE
SMAFJ350A	SMAFJ350CA	350	391	432	1	1	567	0.7	TG	UG
SMAFJ400A	SMAFJ400CA	400	447	494	1	1	648	0.6	TK	UK
SMAFJ440A	SMAFJ440CA	440	492	543	1	1	713	0.6	TM	UM

Fig.1 Peak Pulse Power Rating Curve

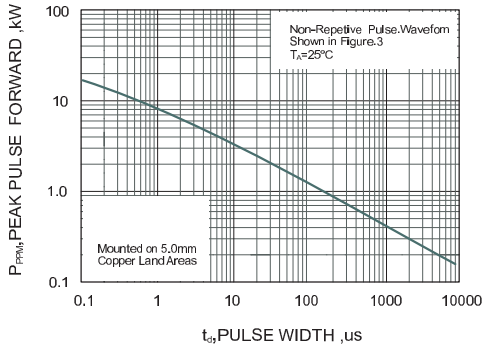

Fig.2 Forward Current Derating Curve

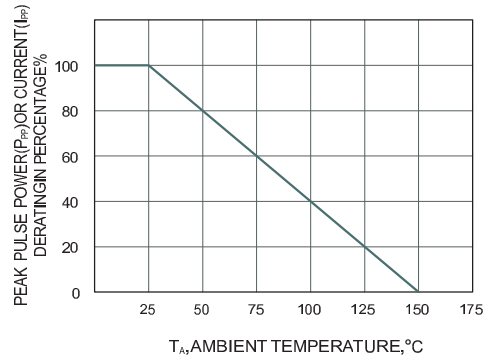

Fig.3 Pulse Waveform

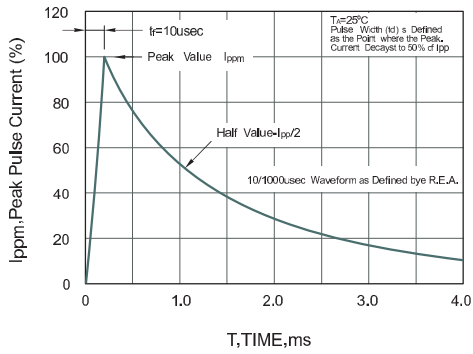
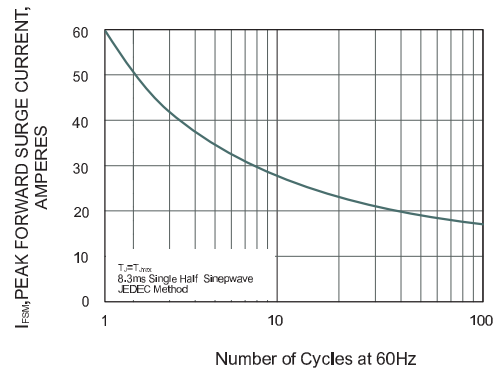

Fig.4 Maximum Non-Repetitive Peak Forward Surge Current



Package Outline

SMAF

Plastic surface mounted package; 2 leads

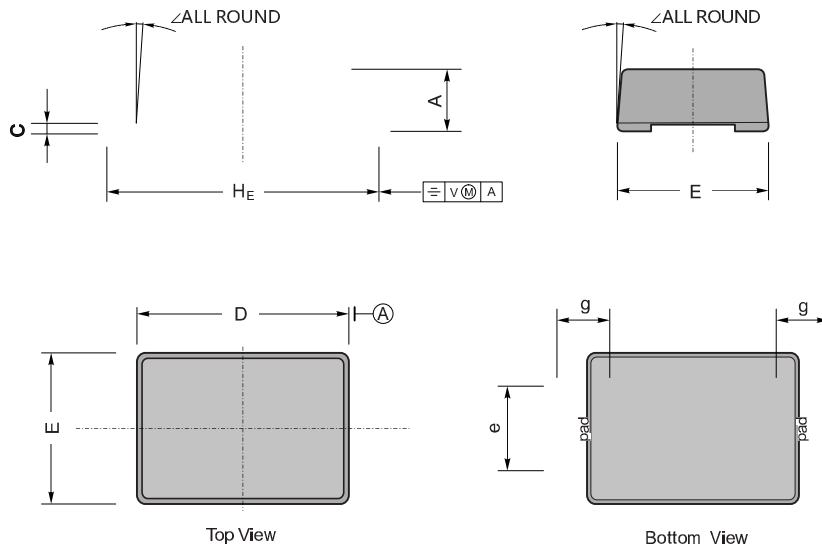

UNIT		A	C	D	E	e	g	H _E	∠
mm	max	1.1	0.20	3.7	2.7	1.6	1.2	4.9	7°
	min	0.9	0.12	3.3	2.4	1.3	0.8	4.4	
mil	max	43	7.9	146	106	63	47	193	
	min	35	4.7	130	94	51	31	173	

The recommended mounting pad size

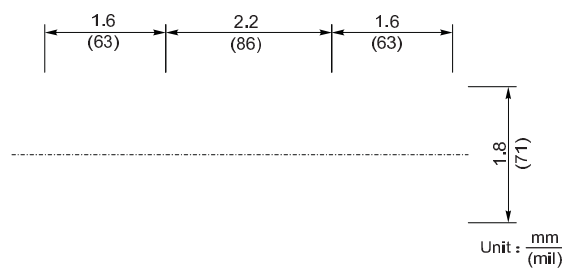

Summary of Packing Options

Package	Packing Description	Packing Quantity	Industry Standard
SMAF	Tape/Reel, 13" reel	10000	EIA-481-1
	Tape/Reel, 7" reel	3000	EIA-481-1

X-ON Electronics

Largest Supplier of Electrical and Electronic Components

Click to view similar products for [ESD Suppressors / TVS Diodes](#) category:

Click to view products by [YFW Electronics](#) manufacturer:

Other Similar products are found below :

[60KS200C](#) [D18V0L1B2LP-7B](#) [D5V0F4U5P5-7](#) [NTE4902](#) [P4KE27CA](#) [P6KE11CA](#) [P6KE8.2A](#) [SA60CA](#) [SA64CA](#) [SMBJ12CATR](#)
[SMBJ33CATR](#) [SMBJ6.5A](#) [SMBJ8.0A](#) [ESD101-B1-02ELS](#) [E6327](#) [ESD112-B1-02EL](#) [E6327](#) [ESD7451N2T5G](#) [19180-510](#) [CPDT-5V0USP-](#)
[HF](#) [3.0SMCJ33CA-F](#) [3.0SMCJ36A-F](#) [HSPC16701B02TP](#) [JANTX1N6126A](#) [D3V3Q1B2DLP3-7](#) [D55V0M1B2WS-7](#) [SCM1293A-04SO](#)
[ESD200-B1-CSP0201](#) [E6327](#) [SM12-7](#) [CEN955](#) [W/DATA](#) [VESD12A1A-HD1-GS08](#) [CPDQC5V0-HF](#) [D1213A-01LP4-7B](#) [ESD101-B1-02EL](#)
[E6327](#) [AOZ8808DI-03](#) [5KP15A](#) [5KP48A](#) [5KP90A](#) [ESD3V3D7-TP](#) [15KPA36A-LF](#) [P4KE56CA](#) [P4KE68A](#) [P4KE91CATR](#) [P6KE120A](#)
[P6KE13CA](#) [P6KE43CA](#) [P6KE6.8CA](#) [P6KE8.2](#) [P6SMBJ20CA](#) [JANTX1N6072A](#) [SR2835ESKG](#) [SA90CA](#)